



Australian Government

IP Australia

AUSTRALIAN OFFICIAL JOURNAL

OF

DESIGNS

Did you know a searchable version of this journal is now available online?

It's FREE and EASY to SEARCH.

Find it on our website (www.ipaustralia.gov.au)

by using the "Journals" link on the home page.

This Page Left Intentionally Blank

Contents

General Information & Notices

**Proceedings Under the Designs Act 1906 preserved as a result of the provisions of Chapter 12
Part 2 of the Designs Act 2003**

Extension of Period of Registration of Designs 1092

Registrations Ceased 1092

Proceedings Under the Designs Act 2003

Applications for Extension of Time Under Section 137 1102

Applications Lapsed 1101

Applications Lodged 1096

Applications Withdrawn 1101

Certificate of Examination 1104

Discharge of Mortgages 1103

Extension of Period of Registration of Design 1102

Extension of Time Granted Under Section 137 1102

Names Registered - Alterations and Amendments 1103

Publication and Registration Proceedings

Designs Registered 341827 to 342026. 1105

Registrations Ceased 1102

Subsequent Owners Registered 1103

This Page Left Intentionally Blank

For information on the following please see our website www.ipaustralia.gov.au or contact our Customer Service Network on 1300651010

[Editorial enquiries](#)

[Contact information](#)

[Freedom of Information ACT](#)

[Professional Standards Board](#)

[Sales](#)

[Requests for Information under Section 194 \(c\)](#)

[Country Codes](#)

[Trade Mark and Designs Hearing Sessions](#)

[INID \(Internationally agreed Numbers for the Identification of Data\)](#)

“INID” NUMBERS in use on Australian Design Documents

“INID” is an acronym for “Internationally agreed Numbers for the Identification of Data”.

(10) Data concerning the registration/renewal

- (11) Serial number of the registration and/or number of the design document
- (12) Plain language designation of the kind of published document
- (19) Identification, using the two-letter code according to WIPO Standard ST.3, of the authority publishing or registering the industrial design

(20) Data concerning the application

- (21) Serial number of the application
- (22) Date of filing of the application
- (24) Date from which the industrial design right has effect

(30) Data relating to priority under the Paris Convention

- (31) Serial number assigned to the priority application
- (32) Date of filing of the priority application
- (33) Two-letter code, according to WIPO Standard ST.3, identifying the authority with which the priority application was made

(40) Date(s) of making information available to the public

- (45) Date of publication of the registered industrial design by printing or similar process, or making it available to the public by any other means

(50) Miscellaneous Information

- (51) International Classification for Industrial Designs (class and subclass of the Locarno Classification)
- (54) Designation of article(s) or product(s) covered by the industrial design or title of the industrial design
- (55) Reproduction of the industrial design (e.g., drawing, photograph) and explanations relating to the reproduction
- (56) List of prior art documents, if separate from descriptive text
- (57) Description of characteristic features of the industrial design including indication of colours

(60) References to other legally related application(s) and registration(s)

- (62) Serial number(s) and, if available, filing date(s) of application(s), registration(s) or document(s) related by division
- (66) Serial number(s) of the application, or the registration, of the design(s) which is (are) a variant(s) of the present one

(70) Identification of parties concerned with the application or registration

- (71) Name(s) and address(es) of the applicant(s)
- (72) Name(s) of the creator(s) if known to be such
- (74) Name(s) and address(es) of the representative(s)

This Page Left Intentionally Blank

Nil notices for this journal issue.

Proceedings under the Designs Act 1906 preserved as a result of the provisions of Chapter 12 Part 2 of the Designs Act 2003.

This Page Left Intentionally Blank

Applications Lapsed

There were no Applications Lapsed under this section

Extension of Period of Registration of Designs

1st Period (Section 27A(8))

2nd Period (Section 27A(12))

3rd Period (Section 27A(13))

145219	145467	145524
145526	145527	145537
145592	145626	145835
145908	145953	145954
146074	146332	146568
146615	146929	147220
147555	147575	147635
147636	147777	148150
148588	148892	149089
149363	149611	150084
150176	150891	151043
153910		

Registrations Ceased

Note: Some of the following Registrations may have been previously advertised as ceased. In this instance, the previous advertisement still prevails.

126849	128201	128252
128253	128372	128539
129040	129041	131555
131749	134408	136227
136228	136229	143733
143812	143813	143814
143815	143861	144477
144479	144806	144855
144856	144857	147824
148451	148701	149813

This Page Left Intentionally Blank

Proceedings under the Designs Act 2003.

This Page Left Intentionally Blank

Applications Lodged

Lodgement information is in the following order: **Applicant's Name**; International Classification, Name of Product, Lodgement Date and **Design Number**. If the applicant claims an earlier priority date under an International Convention, the Convention Country and the associated filing date are shown in parentheses before the Lodgement Date. Divisional information will also appear in parentheses before the Lodgement Date.

slottogether; 06-01NES, 06-03NES, t42 childrens table & chair t42 table 800 x 800, t42 table 750 x 1800 t42 chair, 05 Apr 2012	11801/2012	Amey, Philippa L; 06-13C, Towel, (US, 10 Oct 2011) 05 Apr 2012	11736/2012
slottogether; 06-01NES, 06-03NES, Short black coffee table, 05 Apr 2012	11803/2012	Apple Inc.; 14-03A, 14-04, Electronic device, (US, 04 Oct 2011) 04 Apr 2012	11700/2012
slottogether; 06-01NES, 06-03NES, Side circle - stool Side circle - table, Side square - table, 05 Apr 2012	11802/2012	Apple Inc.; 14-03A, 14-04, Electronic device, (US, 04 Oct 2011) 04 Apr 2012	11702/2012
uVu Lid Company, LLC; 07-01NES, Lid for a container, (US, 16 Dec 2011) 11 Apr 2012	11799/2012	Apple Inc.; 14-04, Display screen for electronic device, (US, 04 Oct 2011) 04 Apr 2012	11703/2012
Actervis GmbH; 08-05P, Spanner, (EM, 08 Nov 2011) 16 Apr 2012	11861/2012	Apple Inc.; 14-03A, 14-04, Electronic device, (US, 04 Oct 2011) 04 Apr 2012	11701/2012
Actervis GmbH; 08-01, Rotary tool, (EM, 15 Nov 2011) 16 Apr 2012	11862/2012	Apple Inc.; 14-03A, 14-04, Electronic device, (US, 04 Oct 2011) 04 Apr 2012	11699/2012
Actervis GmbH; 15-05, High pressure washer, (EM, 10 Nov 2011) 16 Apr 2012	11859/2012	Arrow Fastener Co., LLC; 08-05NES, Fastening tool, (US, 11 Oct 2011) 04 Apr 2012	11721/2012
Actervis GmbH; 08-01, Rotary tool, (EM, 15 Nov 2011) 16 Apr 2012	11863/2012	Asics Corporation; 02-04NES, Sport shoe, 10 Apr 2012	11748/2012
Actervis GmbH; 08-01, Rotary tool, (EM, 15 Nov 2011) 16 Apr 2012	11864/2012	Australian Mobile Mining Equipment Systems and Accessories Pty. Limited; 08-05NES, 08-99, A device for unlocking/ opening, lifting and replacing a lid or cover on a container, 02 Apr 2012	11679/2012
Actervis GmbH; 08-05P, Spanner, (EM, 08 Nov 2011) 16 Apr 2012	11860/2012	Australian Mobile Mining Equipment Systems and Accessories Pty. Limited; 08-05NES, 08-99, Apparatus for rotating a container, 02 Apr 2012	11684/2012
Actervis GmbH; 15-05, High pressure washer, (EM, 10 Nov 2011) 16 Apr 2012	11858/2012	Australian Sugarcane Feeds Pty Ltd; 09-07NES, Bale wrapper, 04 Apr 2012	11744/2012
Actervis GmbH; 08-01, Rotary tool, (EM, 15 Nov 2011) 16 Apr 2012	11865/2012	Ballarat Holdings Pty Ltd; 13-03D, A switch housing, 04 Apr 2012	11724/2012
Advantage Line Pty Ltd; 20-03NES, Display sign, 10 Apr 2012	11747/2012	Ballarat Holdings Pty Ltd; 14-02, A cable grommet, 04 Apr 2012	11725/2012
Aluminium Industries of Australia Pty Ltd.; 25-01K, Extrusion, 05 Apr 2012	11711/2012	Bang & Olufsen A/S; 14-01, Loudspeaker, (EM, 11 Oct 2011) 05 Apr 2012	11716/2012
Aluminium Industries of Australia Pty Ltd.; 25-01K, Extrusion, 05 Apr 2012	11712/2012	Bang & Olufsen A/S; 14-01, Loudspeaker, (EM, 11 Oct 2011) 05 Apr 2012	11717/2012
Aluminium Industries of Australia Pty Ltd.; 25-01K, Extrusion, 05 Apr 2012	11710/2012	Beba Enterprises Pty Ltd; 02-02C, 02-02NES, Articles of clothing, 04 Apr 2012	11714/2012
		Beba Enterprises Pty Ltd; 02-02NES, Top, 24 Oct 2011	11876/2012

Beba Enterprises Pty Ltd; 02-02C, Dress, 24 Oct 2011	11878/2012	Caterpillar Inc.; 15-04, Tip for a ground engaging machine implement, (US, 07 Oct 2011) 10 Apr 2012	11768/2012
Beba Enterprises Pty Ltd; 02-02C, Dress, 24 Oct 2011	11879/2012	Caterpillar Inc.; 15-04, 15-99, Tip for a ground engaging machine implement, (US, 07 Oct 2011) 10 Apr 2012	11783/2012
Beba Enterprises Pty Ltd; 02-02NES, Top, 24 Oct 2011	11877/2012	Caterpillar Inc.; 15-04, Tip for a ground engaging machine implement, (US, 07 Oct 2011) 10 Apr 2012	11773/2012
Beba Enterprises Pty Ltd; 02-02NES, Jacket, 24 Oct 2011	11874/2012	Caterpillar Inc.; 15-04, Tip for a ground engaging machine implement, (US, 07 Oct 2011) 10 Apr 2012	11774/2012
Beba Enterprises Pty Ltd; 02-02C, Skirt, 24 Oct 2011	11875/2012	Caterpillar Inc.; 15-04, 15-99, Tip for a ground engaging machine implement, (US, 07 Oct 2011) 10 Apr 2012	11784/2012
Beba Enterprises Pty Ltd; 02-02C, Dress, 24 Oct 2011	11873/2012	Caterpillar Inc.; 15-04, 15-99, Tip for ground engaging machine implement, 10 Apr 2012	11780/2012
Binder Production Pty Ltd; 02-04NES, An article of footwear, 10 Apr 2012	11729/2012	Caterpillar Inc.; 15-04, Tip for a ground engaging machine implement, (US, 07 Oct 2011) 10 Apr 2012	11769/2012
Blackmagic Design Pty Ltd; 16-01, Camera, 13 Apr 2012	11840/2012	Caterpillar Inc.; 15-04, Tip for a ground engaging machine implement, (US, 07 Oct 2011) 10 Apr 2012	11770/2012
Blackmagic Design Pty Ltd; 16-01, Camera, 13 Apr 2012	11839/2012	Caterpillar Inc.; 15-04, 15-99, Tip for a ground engaging machine implement, 10 Apr 2012	11781/2012
Blackmagic Design Pty Ltd; 23-04, Miniconverter, 13 Apr 2012	11837/2012	Caterpillar Inc.; 15-04, Tip for a ground engaging machine implement, (US, 07 Oct 2011) 10 Apr 2012	11771/2012
Blackmagic Design Pty Ltd; 16-01, Camera, 13 Apr 2012	11838/2012	Caterpillar Inc.; 15-04, Tip for a ground engaging machine implement, (US, 07 Oct 2011) 10 Apr 2012	11772/2012
BGC (Australia) Pty Ltd; 25-01A, Brick stack, 10 Apr 2012	11753/2012	Caterpillar Inc.; 15-04, 15-99, Tip for a ground engaging machine implement, 10 Apr 2012	11782/2012
BGC (Australia) Pty Ltd; 25-01A, Brick stack, 10 Apr 2012	11751/2012	Caterpillar Inc.; 15-04, Tip for a ground engaging machine implement, (US, 07 Oct 2011) 10 Apr 2012	11778/2012
BGC (Australia) Pty Ltd; 25-01A, Brick stack, 10 Apr 2012	11752/2012	Caterpillar Inc.; 15-04, Tip for a ground engaging machine implement, (US, 07 Oct 2011) 10 Apr 2012	11765/2012
Calcino Corporation Pty Ltd; 15-99, 08-99, Sprocket, 10 Apr 2012	11756/2012	Caterpillar Inc.; 15-04, Tip for a ground engaging machine implement, (US, 07 Oct 2011) 10 Apr 2012	11766/2012
Caroma Industries Limited; 23-02C, A cistern flushing button assembly, (Divisional of 10627/2012) 09 Feb 2012	11719/2012	Caterpillar Inc.; 15-04, Adapter for a ground engaging machine implement, (US, 07 Oct 2011) 10 Apr 2012	11779/2012
Carter, Paul; 12-16NES, Motor vehicle registration label holder, 04 Apr 2012	11718/2012	Caterpillar Inc.; 15-04, Adapter for a ground engaging machine implement, (US, 07 Oct 2011) 10 Apr 2012	11777/2012
Caterpillar Inc.; 15-04, Adapter for a ground engaging machine implement, (US, 07 Oct 2011) 10 Apr 2012	11776/2012		
Caterpillar Inc.; 15-04, 15-99, Tip for ground engaging machine implement, (US, 07 Oct 2011) 10 Apr 2012	11785/2012		
Caterpillar Inc.; 15-04, Tip for a ground engaging machine implement, (US, 07 Oct 2011) 10 Apr 2012	11775/2012		
Caterpillar Inc.; 15-04, Tip for a ground engaging machine implement, (US, 07 Oct 2011) 10 Apr 2012	11764/2012		
Caterpillar Inc.; 15-04, Tip for a ground engaging machine implement, (US, 07 Oct 2011) 10 Apr 2012	11767/2012		

Columbus McKinnon Corporation; 15-99, Linear actuator, (US, 09 Oct 2011) 02 Apr 2012	11662/2012	E.D. Oates Pty Ltd; 04-01, Cleaning implement, 05 Apr 2012	11738/2012
Constar International Inc; 09-01NES, Panel for a container, (US, 03 Aug 2011) (Divisional of 10505/2012) 01 Feb 2012	11754/2012	Edwards, Luke John; 02-02NES, T-shirt, 13 Apr 2012	11834/2012
Constar International Inc; 09-01NES, Panel for a container, (US, 03 Aug 2011) (Divisional of 10505/2012) 01 Feb 2012	11755/2012	Edwards, Luke John; 02-02NES, T-shirt, 13 Apr 2012	11835/2012
Cook, Michael John; 21-01B, 06-09, Stuffed toy and neck cushion, 30 Mar 2012	11660/2012	Edwards, Luke John; 02-02NES, T-shirt, 13 Apr 2012	11836/2012
Corrida Holdings (Pty) Ltd; 02-04NES, Footwear, (ZA, 13 Dec 2011) 12 Apr 2012	11822/2012	Edwards, Luke John; 02-02NES, T-shirt, 13 Apr 2012	11828/2012
Country Road Clothing Pty Ltd; 20-02NES, A stand, 13 Apr 2012	11817/2012	Edwards, Luke John; 02-02NES, T-shirt, 13 Apr 2012	11832/2012
Country Road Clothing Pty Ltd; 02-02C, 02-02NES, A garment, 13 Apr 2012	11806/2012	Edwards, Luke John; 02-02NES, T-shirt, 13 Apr 2012	11833/2012
CENTRIX, INC.; 24-04, Dental bite block, (US, 17 Oct 2011) 10 Apr 2012	11730/2012	Edwards, Luke John; 02-02NES, T-shirt, 13 Apr 2012	11829/2012
Dart Industries Inc.; 07-01F, Pitcher, (US, 21 Dec 2011) 11 Apr 2012	11793/2012	Edwards, Luke John; 02-02NES, T-shirt, 13 Apr 2012	11826/2012
Dart Industries Inc.; 07-01D, 07-01NES, Combined cover and saucer, (US, 11 Dec 2011) 11 Apr 2012	11792/2012	Edwards, Luke John; 02-02NES, T-shirt, 13 Apr 2012	11827/2012
Dart Industries Inc.; 07-01D, Cup, (US, 21 Dec 2011) 11 Apr 2012	11791/2012	Edwards, Luke John; 02-02NES, T-shirt, 13 Apr 2012	11824/2012
Dart Industries Inc.; 07-01F, Covered pitcher, (US, 21 Dec 2011) 11 Apr 2012	11789/2012	Edwards, Luke John; 02-02NES, T-shirt, 13 Apr 2012	11830/2012
Dart Industries Inc.; 07-02K, Teapot, (US, 29 Dec 2011) 11 Apr 2012	11790/2012	Edwards, Luke John; 02-02NES, T-shirt, 13 Apr 2012	11831/2012
Dart Industries Inc.; 07-01NES, Cover for a container, (US, 22 Nov 2011) 11 Apr 2012	11788/2012	Edwards, Luke John; 02-02NES, T-shirt, 13 Apr 2012	11825/2012
De Buyer Industries; 31-00, Culinary paste gun, 05 Apr 2012	11741/2012	Evergreen Land Limited; 25-02C, Insect repellent refill tablet, 29 Mar 2012	11656/2012
Designer Vans Pty Ltd; 12-10, Camper van body, 13 Apr 2012	11846/2012	Everhard Industries Pty Ltd; 23-02NES, 23-02E, Grease/silt arrestor, 05 Apr 2012	11740/2012
Disher, Paul Andrew; 25-02C, Fence panel frame, 30 Mar 2012	11655/2012	Everstone International Pty Limited; 25-01F, Tesserae, 13 Apr 2012	11847/2012
Disher, Paul Andrew; 25-02C, Gate frame, 30 Mar 2012	11657/2012	Everstone International Pty Limited; 25-01F, Tesserae, 13 Apr 2012	11848/2012
Disher, Paul Andrew; 25-02C, Scroll ornament, 30 Mar 2012	11658/2012	Everstone International Pty Limited; 25-01F, Tesserae, 13 Apr 2012	11849/2012
Disher, Paul Andrew; 25-02C, Gate frame, 30 Mar 2012	11654/2012	Everstone International Pty Limited; 25-01F, Tesserae, 13 Apr 2012	11850/2012
		Facey, Jeanette; 07-02P, Cake pop mould, 10 Apr 2012	11761/2012
		Facey, Jeanette; 07-02P, Cake pop mold, 10 Apr 2012	11763/2012
		Facey, Jeanette; 07-02P, Cake pop mold, 10 Apr 2012	11762/2012
		Fergusson, Kim; 26-05B, A decorative fabrication of metal or plastic, 11 Apr 2012	11787/2012

Fisher, Harald; 06-06NES, 20-02NES, Music stand adapter, 16 Apr 2012	11867/2012	LEO Laboratories Limited; 09-03M, Packaging Blank, 04 Apr 2012	11731/2012
Funky Theme Kids Beds Pty Ltd; 06-02, Fairy bed, 02 Apr 2012	11687/2012	LEO Laboratories Limited; 09-03M, Package, 04 Apr 2012	11732/2012
Funky Theme Kids Beds Pty Ltd; 06-04F, Fairy bed drawers, 02 Apr 2012	11745/2012	LSI Industries, Inc.; 26-03, Lighting, (US, 02 Nov 2011) 13 Apr 2012	11820/2012
Funky Theme Kids Beds Pty Ltd; 06-04F, Fairy bed drawers, 02 Apr 2012	11746/2012	Mace Engineering Group; 12-16NES, Ford motor vehicle air intake, 02 Apr 2012	11652/2012
Funky Theme Kids Beds Pty Ltd; 06-02, Fairy bed, 02 Apr 2012	11689/2012	McPherson's Limited; 07-02P, 07-99A, Baking tray, 12 Apr 2012	11814/2012
Gondwana Outdoor Clothing Co Pty Ltd; 02-02C, Clothing, 29 Mar 2012	11674/2012	McPherson's Limited; 07-02P, 07-99A, Baking tray, 12 Apr 2012	11810/2012
Helicopter Systems Limited; 12-07, A helicopter, (NZ, 11 Oct 2011) 11 Apr 2012	11795/2012	McPherson's Limited; 07-02P, 07-99A, Baking tray, 12 Apr 2012	11811/2012
Jamieson, Darren; 21-01H, Footy dart board game, 05 Apr 2012	11709/2012	McPherson's Limited; 07-02P, 07-99A, Baking tray, 12 Apr 2012	11815/2012
Johnson Controls Technology Company; 13-02, Battery charger housing, (US, 21 Oct 2011) 13 Apr 2012	11857/2012	McPherson's Limited; 07-99A, 07-02P, Baking tray, 12 Apr 2012	11812/2012
Kagi IP Holding Company Limited; 20-02NES, A jewellery display block, (NZ, 05 Aug 2011) 03 Feb 2012	11715/2012	McPherson's Limited; 07-02P, 07-99A, Baking tray, 12 Apr 2012	11813/2012
Kennard, Joanne May; Kennard, Grant Richard; 07-02E, Textile camp oven, 12 Apr 2012	11804/2012	Mezzo Movies Limited; 14-99, 14-02, Holders for computers, (EM, 07 Oct 2011) 05 Apr 2012	11733/2012
Kennard, Grant Richard; Kennard, Joanne May; 07-02E, Textile camp oven, 12 Apr 2012	11804/2012	Mills, Christopher Laurie; 12-06NES, Houseboat, 02 Apr 2012	11650/2012
Kistler Holding AG; 10-05, Force sensor, (CN, 11 Oct 2011) 12 Apr 2012	11821/2012	Minelab Electronics Pty Limited; 10-05, Metal detector body, 05 Apr 2012	11737/2012
Knight, Murray John; 05-05NES, A cover, 05 Apr 2012	11720/2012	Morphun Research Limited; 21-01E, A toy building element, (EM, 05 Dec 2011) 13 Apr 2012	11844/2012
Kurmis, Manfred Imand; 09-01H, Bottle, 11 Apr 2012	11796/2012	Morrison, Brian; 20-02NES, Combination dispenser and advertising display, (US, 10 Oct 2011) 10 Apr 2012	11794/2012
Kurmis, Manfred Imand; 09-07C, Sealing member for a closure, 11 Apr 2012	11797/2012	Move Collective LLC; 09-07C, Bottle cap, (US, 03 Oct 2011) 03 Apr 2012	11686/2012
Lancellotti, Robert; 26-06, LED, Vehicle emergency-hazard warning light, 13 Apr 2012	11852/2012	My Myk Pty Limited; 14-01, Audio mixing device, 04 Apr 2012	11726/2012
Larkin & Shoushani Solutions Pty Ltd; 23-01G, Bucket trap, 04 Apr 2012	11734/2012	Nassar, Michael; 15-03B, Electric brush cutter attachment for ride on lawn mower/ tractor, 03 Apr 2012	11661/2012
Lava Ltd; 16-06, Sunglasses, 03 Apr 2012	11722/2012	Ningbo Beilun Automotive Lamp Co Ltd; 26-06, Led bullbar lamp, 10 Apr 2012	11743/2012
Lava Ltd; 16-06, Sunglasses, 03 Apr 2012	11723/2012	NCI Holdings Pty Ltd; 08-99, Clip, 05 Apr 2012	11739/2012
Lifetime Products, Inc.; 06-03A, Table top, (Divisional of 10961/2012) 29 Feb 2012	11800/2012	Oakley, Inc.; 16-06, Eyeglass, (US, 05 Oct 2011) 04 Apr 2012	11708/2012
Lubbock, William John; 25-03, Pyramoidal pagoda, 05 Apr 2012	11713/2012		

Pentair Water Pool and Spa, Inc.; 08-05A, A pool cleaner, (US, 03 Oct 2011) 03 Apr 2012	11678/2012	Roxtec AB; 25-01NES, Cable and pipe penetration seals, 16 Apr 2012	11870/2012
Piaggio & C. S.p.A.; 12-11, Motor scooter, (IT, 13 Oct 2011) 11 Apr 2012	11757/2012	RGS Direct LLC; 21-02C, Portable multi-sport practice net, (US, 25 Oct 2011) 05 Apr 2012	11735/2012
Pompey, Andrea Debora; 08-03, Knife guilding implement, 30 Mar 2012	11659/2012	S.C. Johnson & Son Inc.; 02-04A, Insole, (US, 11 Oct 2011) 04 Apr 2012	11707/2012
Reckitt & Colman (Overseas) Limited; 09-01NES, Part of dispensing device, (EM, 03 Oct 2011) 03 Apr 2012	11692/2012	Santos, (a French societe par actions simplifree); 07-04, Coffee grinder, (EM, 18 Oct 2011) 10 Apr 2012	11749/2012
Reckitt & Colman (Overseas) Limited; 09-01NES, Dispensing device, (EM, 03 Oct 2011) 03 Apr 2012	11688/2012	Socram Pty Ltd, ATF Central Autohaus Discretionary fund T/AS Central Autohaus; 20-03NES, 25-02H, Motor vechicle maintenance and repair Servicing of cars, Servicing of vechicles, 10 Apr 2012	11728/2012
Reckitt & Colman (Overseas) Limited; 09-01NES, Dispensing device, (EM, 03 Oct 2011) 03 Apr 2012	11693/2012	Strange, Stephen; 08-08L, A bracket, 03 Apr 2012	11677/2012
Reckitt & Colman (Overseas) Limited; 09-01NES, Dispensing device, (EM, 03 Oct 2011) 03 Apr 2012	11691/2012	Suzuki Motor Corporation; 12-08, Automobile, (JP, 11 Oct 2011) 10 Apr 2012	11750/2012
Rentschler Reven-Luftungssysteme GmbH; 23-04, Air cleaner, (EM, 13 Feb 2012) 13 Apr 2012	11843/2012	SAVERGLASS; 09-01H, Bottle, (EM, 11 Oct 2011) 04 Apr 2012	11705/2012
ResMed Paris SAS; 24-01, Expiratory valve, (US, 05 Aug 2011) 13 Jan 2012	11695/2012	SAVERGLASS; 09-01H, Bottle, (EM, 11 Oct 2011) 04 Apr 2012	11706/2012
ResMed Paris SAS; 24-01, Expiratory adaptor, (US, 05 Aug 2011) 13 Jan 2012	11696/2012	SAVERGLASS; 09-01H, Bottle, (EM, 11 Oct 2011) 04 Apr 2012	11704/2012
ResMed Paris SAS; 24-01, Filter cartridge, (US, 05 Aug 2011) 13 Jan 2012	11698/2012	SULO MGB Australia Pty Ltd; 09-07NES, Lid, 03 Apr 2012	11681/2012
ResMed Paris SAS; 24-01, Filter assembly, (US, 05 Aug 2011) 13 Jan 2012	11697/2012	Taylor, John Reeves; 21-01NES, A rolling toy, 03 Apr 2012	11682/2012
Revlon Consumer Products Corporation; 28-03NES, Nail file, (US, 03 Apr 2012) 04 Apr 2012	11742/2012	Taylor, John Reeves; 21-01NES, A rolling toy, 03 Apr 2012	11683/2012
Richardson, Cled; 25-02H, Composite windows, 30 Mar 2012	11653/2012	The Gates Corporation; 08-05NES, 12-16NES, Timing belt spacer tool, 13 Apr 2012	11845/2012
Rickitt & Colman Overseas Limited; 09-01NES, Dispensing device, (EM, 03 Oct 2011) 03 Apr 2012	11690/2012	The Procter & Gamble Company; 19-08, Label for an oral care product, (US, 10 Oct 2011) 10 Apr 2012	11759/2012
Rogers, David; 14-02, Invertavision "A-frame" laptop stand, 13 Apr 2012	11889/2012	The Procter & Gamble Company; 19-08, Label for an oral care product, (US, 10 Oct 2011) 10 Apr 2012	11760/2012
Roxtec AB; 25-01NES, Cable and pipe penetration seals, 16 Apr 2012	11871/2012	The Procter & Gamble Company; 19-08, Label for an oral care product, (US, 10 Oct 2011) 10 Apr 2012	11758/2012
Roxtec AB; 25-01NES, Cable and pipe penetration seals, 16 Apr 2012	11869/2012	Therapearl, LLC; 24-04, Thermal pack, (US, 06 Oct 2011) 05 Apr 2012	11727/2012

Thermos L.L.C.; 09-01NES, A drink bottle lid with incorporating a button release cover, (US, 13 Oct 2011) 12 Apr 2012	11805/2012	Vicjan Pty Ltd; 13-03D, Large 10amp or 15amp electrical outlet, 12 Apr 2012	11897/2012
TFXMarine, Inc.; 12-16A, Steering bezel, (US, 14 Oct 2011) 13 Apr 2012	11841/2012	Vita-Mix Corporation; 31-00, Blender container, (US, 06 Dec 2011) 12 Apr 2012	11807/2012
TFXMarine, Inc.; 12-16A, Steering bezel, (US, 14 Oct 2011) 13 Apr 2012	11842/2012	Vita-Mix Corporation; 31-00, Blender base, (US, 06 Dec 2011) 12 Apr 2012	11808/2012
Varier Furniture AS; 06-01F, Seat, (NO, 12 Mar 2012) 03 Apr 2012	11694/2012	Vita-Mix Corporation; 31-00, Blender base, (US, 21 Dec 2011) 12 Apr 2012	11809/2012
Vicjan Pty Ltd; 13-03D, 10amp or 15amp IP rated electrical socket, 12 Apr 2012	11895/2012	Vugs, Troy; 23-02B, Shower tray, 05 Apr 2012	11816/2012
Vicjan Pty Ltd; 13-03D, 10amp or 15amp electrical plug, 12 Apr 2012	11898/2012	Whites Group Pty Ltd; 08-08O, 25-01E, Stake, 11 Apr 2012	11798/2012
Vicjan Pty Ltd; 13-03D, Electrical power board stand, 12 Apr 2012	11899/2012	WIK SP.ZO.O.; 25-03, Building, 12 Apr 2012	11819/2012
Vicjan Pty Ltd; 13-03D, Small 10amp or 15amp electrical outlet, 12 Apr 2012	11896/2012	Y-Gen Enterprises Pty Ltd; 06-04NES, Racking system, 11 Apr 2012	11786/2012
		Yoshida Metal Industry Co., Ltd; 07-03, 08-03, Cutlery handle, (JP, 26 Mar 2012) 12 Apr 2012	11818/2012

Applications Withdrawn

15076 / 2011 (02-02NES)	15077 / 2011 (02-01A)
15079 / 2011 (02-01B)	15081 / 2011 (02-01B)
15082 / 2011 (02-01B)	15085 / 2011 (02-02NES)
15086 / 2011 (02-02NES)	15087 / 2011 (02-02C)
15088 / 2011 (02-02NES)	15090 / 2011 (02-02NES)
15091 / 2011 (02-02NES)	15092 / 2011 (02-02NES)
15093 / 2011 (02-01B)	15094 / 2011 (02-01B)
15095 / 2011 (02-02C)	15096 / 2011 (02-02C)
15097 / 2011 (02-02C)	15099 / 2011 (02-02C)
15101 / 2011 (02-02C)	15102 / 2011 (02-02C)
15103 / 2011 (02-02NES)	15104 / 2011 (02-02C)
15105 / 2011 (05-05NES)	15106 / 2011 (05-05NES)
15107 / 2011 (05-05NES)	15108 / 2011 (05-05NES)
10890 / 2012 (07-01NES)	

Applications Lapsed

13006 / 2011 (25-01K)	13007 / 2011 (08-08D)
14476 / 2011 (09-03H)	15791 / 2011 (12-16NES)
10565 / 2012 (99-00)	

Extension of Period of Registration of Designs

312921	313270	313741
314606	314607	314608
314609	314805	314861
314862	314890	314891
314892	314893	314894
314895	314943	314944
314951	314957	315017
315039	315043	315052
315070	315112	315113
315114	315115	315117
315120	315135	315136
315157	315169	315174
315175	315178	315179
315180	315181	315205
315208	315209	315210
315211	315238	315250
315251	315252	315253
315254	315255	315256
315263	315264	315265
315266	315267	315276
315277	315279	315287
315289	315291	315292
315293	315294	315295
315296	315297	315298
315299	315300	315301
315302	315315	315324
315334	315349	315538
315635	315671	315736
315815	315880	315881
315882	315883	315884
315885	315937	315978
315980	315981	316142
316244	316373	316374
316375	316376	316377
316378	316379	316380
316381	316416	316417
316418	316419	316420
317436	317720	318763

Registrations Ceased

310449	311023	311026
311027	311046	311061
311068	311069	311070
311072	311085	311086
311089	311096	311097
311098	311099	311100
311101	311102	311103
311104	311105	311106
311109	311110	311111

311112	311120	311121
311123	311124	311125
311126	311131	311146
311168	311169	311170
311171	311172	311207
311228	311230	311233
311234	311235	311236
311239	311249	311250
311255	311256	311274
311275	311276	311442
311443	311444	311445
311446	311447	311502
311578	311579	311581
311611	311739	311740
311749	311750	311807
311825	311845	311867
312093	312094	312110
312235	312236	312382
312383	312384	312437
312492	312506	312507
312508	312510	312511
312512	312513	312514
312515	312601	312767
313015	313148	313489
313530	313531	313551
314674	321028	321029
321030	336019	337393

Applications for Extension of time under Section 137

Applications under section 137 for extension of time have been lodged. Objections must be lodged within 1 month from the date of this journal.

308514 **Paul Damian Nelson** Address for Service: Corrs Chambers Westgarth National Trade Mark Group GPO Box 9925 MELBOURNE VIC 3001

Extensions of time granted under Section 137

Applications lodged under section 137 for extension of time have been granted.

335711 **Removerite Incorporated**

335712 **Removerite Incorporated**

336727 **3M Innovative Properties Company**

342003 **Paul Geoffrey Spittle**

342004 **Paul Geoffrey Spittle**

15074/2011 **LM Australasia**

15075/2011 **LM Australasia**

15076/2011 **LM Australasia**

15077/2011 **LM Australasia**

15078/2011 LM Australasia
 15079/2011 LM Australasia
 15080/2011 LM Australasia
 15081/2011 LM Australasia
 15082/2011 LM Australasia
 15083/2011 LM Australasia
 15084/2011 LM Australasia
 15085/2011 LM Australasia
 15086/2011 LM Australasia
 15087/2011 LM Australasia
 15088/2011 LM Australasia
 15089/2011 LM Australasia
 15090/2011 LM Australasia
 15091/2011 LM Australasia
 15092/2011 LM Australasia
 15093/2011 LM Australasia
 15094/2011 LM Australasia
 15095/2011 LM Australasia
 15096/2011 LM Australasia
 15097/2011 LM Australasia
 15098/2011 LM Australasia
 15099/2011 LM Australasia
 15100/2011 LM Australasia
 15101/2011 LM Australasia
 15102/2011 LM Australasia
 15103/2011 LM Australasia
 15104/2011 LM Australasia
 15105/2011 LM Australasia
 15106/2011 LM Australasia
 15107/2011 LM Australasia
 15108/2011 LM Australasia

341920 Rammite Pty Ltd Trading as Missionpac

Discharge of Mortgages

306007 The mortgage to **The Royal Bank of Scotland plc** has been discharged.
 306008 The mortgage to **The Royal Bank of Scotland plc** has been discharged.
 306991 The mortgage to **The Royal Bank of Scotland plc** has been discharged.

306992 The mortgage to **The Royal Bank of Scotland plc** has been discharged.
 306993 The mortgage to **The Royal Bank of Scotland plc** has been discharged.
 306994 The mortgage to **The Royal Bank of Scotland plc** has been discharged.
 306995 The mortgage to **The Royal Bank of Scotland plc** has been discharged.
 306990 The mortgage to **The Royal Bank of Scotland plc** has been discharged.
 306985 The mortgage to **The Royal Bank of Scotland plc** has been discharged.
 306986 The mortgage to **The Royal Bank of Scotland plc** has been discharged.
 306987 The mortgage to **The Royal Bank of Scotland plc** has been discharged.
 306988 The mortgage to **The Royal Bank of Scotland plc** has been discharged.
 306989 The mortgage to **The Royal Bank of Scotland plc** has been discharged.
 308056 The mortgage to **The Royal Bank of Scotland plc** has been discharged.
 308676 The mortgage to **The Royal Bank of Scotland plc** has been discharged.
 313534 The mortgage to **The Royal Bank of Scotland plc** has been discharged.

Subsequent Owners Registered

(The name in parentheses is that of the subsequent owner)

328610 (**Madeleine Potter;Jaquie Hagan**) Memake Pty Limited
 305677 (**Vlaeberg Pty Ltd**) QuickFrame Technologies Pty Ltd
 305760 (**Vlaeberg Pty Ltd**) QuickFrame Technologies Pty Ltd
 305722 (**Vlaeberg Pty Ltd**) QuickFrame Technologies Pty Ltd
 305675 (**Vlaeberg Pty Ltd**) QuickFrame Technologies Pty Ltd
 305676 (**Vlaeberg Pty Ltd**) QuickFrame Technologies Pty Ltd

Names Registered - Alterations and Amendments

(The name in parentheses is that of the subsequent applicant)

315136 (**Norma Sweden AB**) ABA of Sweden AB
 315135 (**Norma Sweden AB**) ABA of Sweden AB
 337352 (**Happy Captain Pty Ltd**) Captain Hook Pty Ltd

Certificate(s) of Examination

Examination of the following Design Registration(s) has been completed. Infringement proceedings may now be commenced.

311262	25-01NES	13/04/2012
319826	24-02	18/04/2012
326851	25-02H	16/04/2012
330426	02-02NES	13/04/2012
330678	21-02F	11/04/2012
331909	07-05D	18/04/2012
335511	12-06C	19/04/2012
338107	02-04B	17/04/2012
338496	06-06E	17/04/2012
339587	13-03B	16/04/2012
339614	04-02	11/04/2012
339836	27-01	13/04/2012
339967	08-03	15/04/2012
339981	08-03	15/04/2012
340240	21-03	17/04/2012
340245	15-01	13/04/2012
340509	23-01K	11/04/2012
340535	15-05	12/04/2012
340536	15-05	12/04/2012
340537	15-05	12/04/2012
340604	10-04	17/04/2012
340605	10-04	17/04/2012
340704	05-05NES	17/04/2012
340732	23-01K	11/04/2012
340733	25-03	17/04/2012
341102	09-01D	18/04/2012

Publication and Registration Proceedings

Designs Registered

This section provides a concordance between design number and registration number of Designs covered in this journal. It also shows the main class and registration date.

This section covers Registration numbers 341827 to 342026 .

The registration number shown below should be used in all future correspondence.

Design Number	Registration Number	International Classification Code (IDC)	Registration Date	Design Number	Registration Number	International Classification Code (IDC)	Registration Date
13438/2011	341916	09-03NES	16/04/2012	11051/2012	341892	02-02A	16/04/2012
13439/2011	341917	09-03NES	16/04/2012	11052/2012	341893	02-02A	16/04/2012
13440/2011	341918	09-03NES	16/04/2012	11053/2012	341894	02-02A	16/04/2012
13701/2011	341919	09-09	16/04/2012	11054/2012	341895	02-02A	16/04/2012
13796/2011	341999	09-02A	18/04/2012	11055/2012	341896	02-02A	16/04/2012
14615/2011	342000	21-02D	18/04/2012	11056/2012	341897	02-02A	16/04/2012
14632/2011	342001	12-16B	18/04/2012	11057/2012	341898	02-02A	16/04/2012
14634/2011	342025	12-16B	19/04/2012	11058/2012	341899	02-02A	16/04/2012
14635/2011	342002	12-16B	18/04/2012	11059/2012	341900	02-02A	16/04/2012
14643/2011	341868	19-02	13/04/2012	11060/2012	341901	02-02A	16/04/2012
14786/2011	342026	08-08NES	19/04/2012	11061/2012	341902	02-02A	16/04/2012
14823/2011	342006	02-02C	19/04/2012	11062/2012	341903	02-02A	16/04/2012
14895/2011	342003	23-02C	18/04/2012	11063/2012	341904	02-02A	16/04/2012
14896/2011	342004	23-02C	18/04/2012	11064/2012	341905	02-02A	16/04/2012
15623/2011	341827	09-03F	10/04/2012	11065/2012	341906	02-02A	16/04/2012
10151/2012	341869	24-01	13/04/2012	11066/2012	341907	02-02A	16/04/2012
10247/2012	341932	14-02	17/04/2012	11067/2012	341908	02-02A	16/04/2012
10250/2012	341920	02-02NES	16/04/2012	11068/2012	341909	02-02A	16/04/2012
10303/2012	341986	23-04	18/04/2012	11069/2012	341910	02-02A	16/04/2012
10311/2012	341933	09-07A	17/04/2012	11070/2012	341911	02-02A	16/04/2012
10313/2012	341934	07-05NES	17/04/2012	11071/2012	341912	02-02A	16/04/2012
10337/2012	341948	15-02	17/04/2012	11072/2012	341913	02-02A	16/04/2012
10338/2012	341949	07-05NES	17/04/2012	11073/2012	341914	02-02A	16/04/2012
10505/2012	341972	09-01NES	18/04/2012	11074/2012	341915	02-02A	16/04/2012
10559/2012	341874	20-02NES	13/04/2012	11097/2012	341984	09-07B	18/04/2012
10560/2012	341876	02-07NES	13/04/2012	11098/2012	341985	09-03NES	18/04/2012
10564/2012	341979	07-02NES	18/04/2012	11168/2012	341828	24-01	11/04/2012
10567/2012	341980	07-02NES	18/04/2012	11170/2012	341829	14-04	11/04/2012
10575/2012	341839	05-05NES	12/04/2012	11171/2012	341830	14-04	11/04/2012
10578/2012	341950	07-04	17/04/2012	11172/2012	341831	14-04	11/04/2012
10579/2012	341951	07-04	17/04/2012	11173/2012	341832	14-04	11/04/2012
10580/2012	341952	07-04	17/04/2012	11174/2012	341833	14-04	11/04/2012
10581/2012	341953	07-04	17/04/2012	11175/2012	341834	14-04	11/04/2012
10582/2012	341954	07-04	17/04/2012	11176/2012	341835	14-04	11/04/2012
10587/2012	341921	31-00	16/04/2012	11177/2012	341836	14-04	11/04/2012
10627/2012	341975	23-02C	18/04/2012	11178/2012	341837	23-01B	11/04/2012
10784/2012	341981	23-01K	18/04/2012	11179/2012	341838	14-04	11/04/2012
10787/2012	341977	06-04NES	18/04/2012	11180/2012	341843	14-04	12/04/2012
10802/2012	341935	09-07B	17/04/2012	11181/2012	341844	14-04	12/04/2012
10837/2012	341928	23-03H	16/04/2012	11182/2012	341845	14-04	12/04/2012
10894/2012	341840	07-99NES	12/04/2012	11183/2012	341846	14-04	12/04/2012
10922/2012	341936	02-04NES	17/04/2012	11184/2012	341847	14-04	12/04/2012
10961/2012	341982	06-03B	18/04/2012	11185/2012	341848	14-04	12/04/2012
10988/2012	341983	21-02NES	18/04/2012	11186/2012	341849	14-04	12/04/2012
11014/2012	341929	20-02NES	16/04/2012	11187/2012	341850	23-02NES	12/04/2012
11015/2012	341930	20-02NES	16/04/2012	11188/2012	341851	14-04	12/04/2012
11016/2012	341931	20-02NES	16/04/2012	11189/2012	341852	14-04	12/04/2012
11038/2012	341937	25-01F	17/04/2012	11192/2012	341853	14-04	12/04/2012
11049/2012	341890	02-02A	16/04/2012	11195/2012	341854	14-04	12/04/2012
11050/2012	341891	02-02A	16/04/2012	11196/2012	341855	14-04	12/04/2012

Publication and Registration Proceedings - Designs Registered cont'd

Design Number	Registration Number	International Classification Code (IDC)	Registration Date	Design Number	Registration Number	International Classification Code (IDC)	Registration Date
11197/2012	341856	14-04	13/04/2012	11249/2012	341987	14-04	18/04/2012
11198/2012	341857	14-04	13/04/2012	11250/2012	341988	14-04	18/04/2012
11199/2012	341858	14-04	13/04/2012	11251/2012	341989	14-04	18/04/2012
11200/2012	341859	14-04	13/04/2012	11252/2012	341990	14-04	18/04/2012
11201/2012	341860	14-04	13/04/2012	11253/2012	341991	14-04	18/04/2012
11202/2012	341861	14-04	13/04/2012	11254/2012	341992	14-04	18/04/2012
11203/2012	341862	14-04	13/04/2012	11255/2012	341993	14-04	18/04/2012
11204/2012	341863	14-04	13/04/2012	11256/2012	341994	14-04	18/04/2012
11205/2012	341864	14-04	13/04/2012	11257/2012	341995	09-05	18/04/2012
11206/2012	341865	14-04	13/04/2012	11258/2012	341996	14-04	18/04/2012
11207/2012	341955	14-04	17/04/2012	11259/2012	341997	14-04	18/04/2012
11208/2012	341956	14-04	17/04/2012	11260/2012	341998	14-04	18/04/2012
11209/2012	341957	14-04	17/04/2012	11261/2012	342014	14-04	19/04/2012
11210/2012	341958	14-04	17/04/2012	11262/2012	342015	09-05	19/04/2012
11211/2012	341923	14-04	16/04/2012	11263/2012	342016	14-04	19/04/2012
11212/2012	341924	14-04	16/04/2012	11264/2012	342017	14-04	19/04/2012
11213/2012	341925	14-04	16/04/2012	11265/2012	342018	14-04	19/04/2012
11214/2012	341926	14-04	16/04/2012	11266/2012	342019	14-04	19/04/2012
11215/2012	341927	14-04	16/04/2012	11267/2012	342020	14-04	19/04/2012
11216/2012	341938	14-04	17/04/2012	11268/2012	342021	14-04	19/04/2012
11217/2012	341939	14-04	17/04/2012	11269/2012	342022	14-04	19/04/2012
11218/2012	341940	14-04	17/04/2012	11270/2012	342023	14-04	19/04/2012
11219/2012	341941	14-04	17/04/2012	11271/2012	342024	14-04	19/04/2012
11220/2012	341942	14-04	17/04/2012	11280/2012	341841	09-01D	12/04/2012
11221/2012	341943	14-04	17/04/2012	11281/2012	341842	09-01D	12/04/2012
11222/2012	341866	14-04	13/04/2012	11365/2012	341944	26-06	17/04/2012
11223/2012	341867	14-04	13/04/2012	11414/2012	341945	25-01K	17/04/2012
11224/2012	341878	14-04	16/04/2012	11415/2012	341946	25-01K	17/04/2012
11225/2012	341879	14-04	16/04/2012	11416/2012	341947	25-01K	17/04/2012
11226/2012	341880	14-04	16/04/2012	11428/2012	342005	28-03D	18/04/2012
11227/2012	341881	14-04	16/04/2012	11458/2012	341877	08-05P	13/04/2012
11228/2012	341882	14-04	16/04/2012	11471/2012	341959	26-06	17/04/2012
11229/2012	341883	14-04	16/04/2012	11474/2012	341922	26-06	16/04/2012
11230/2012	341884	14-04	16/04/2012	11519/2012	341978	26-06	18/04/2012
11231/2012	341885	14-04	16/04/2012	11695/2012	341870	24-01	13/04/2012
11232/2012	341886	14-04	16/04/2012	11696/2012	341871	24-01	13/04/2012
11234/2012	341887	14-04	16/04/2012	11697/2012	341872	24-01	13/04/2012
11235/2012	341888	14-04	16/04/2012	11698/2012	341873	24-01	13/04/2012
11236/2012	341889	14-04	16/04/2012	11715/2012	341875	20-02NES	13/04/2012
11237/2012	341960	14-04	17/04/2012	11719/2012	341976	23-02C	18/04/2012
11238/2012	341961	14-04	17/04/2012	11754/2012	341973	09-01NES	18/04/2012
11239/2012	341962	14-04	17/04/2012	11755/2012	341974	09-01NES	18/04/2012
11240/2012	341963	14-04	17/04/2012	11873/2012	342007	02-02C	19/04/2012
11241/2012	341964	14-04	17/04/2012	11874/2012	342008	02-02NES	19/04/2012
11242/2012	341965	14-04	17/04/2012	11875/2012	342009	02-02C	19/04/2012
11243/2012	341966	14-04	17/04/2012	11876/2012	342010	02-02NES	19/04/2012
11244/2012	341967	14-04	17/04/2012	11877/2012	342011	02-02NES	19/04/2012
11245/2012	341968	14-04	17/04/2012	11878/2012	342012	02-02C	19/04/2012
11246/2012	341969	14-04	17/04/2012	11879/2012	342013	02-02C	19/04/2012
11247/2012	341970	14-04	17/04/2012				
11248/2012	341971	14-04	17/04/2012				

Publication and Registration Proceedings

Class Listing of Designs Published or Registered

The following section shows an International Classification Code listing of the Registered or Published Designs covered in this supplement.

Classification	Registration Number	Design Number	Classification	Registration Number	Design Number
02-02A	341890	11049/2012	08-08NES	342026	14786/2011
02-02A	341891	11050/2012	09-01D	341841	11280/2012
02-02A	341892	11051/2012	09-01D	341842	11281/2012
02-02A	341893	11052/2012	09-01NES	341972	10505/2012
02-02A	341894	11053/2012	09-01NES	341973	11754/2012
02-02A	341895	11054/2012	09-01NES	341974	11755/2012
02-02A	341896	11055/2012	09-02A	341999	13796/2011
02-02A	341897	11056/2012	09-03F	341827	15623/2011
02-02A	341898	11057/2012	09-03NES	341916	13438/2011
02-02A	341899	11058/2012	09-03NES	341917	13439/2011
02-02A	341900	11059/2012	09-03NES	341918	13440/2011
02-02A	341901	11060/2012	09-03NES	341985	11098/2012
02-02A	341902	11061/2012	09-05	341995	11257/2012
02-02A	341903	11062/2012	09-05	342015	11262/2012
02-02A	341904	11063/2012	09-07A	341933	10311/2012
02-02A	341905	11064/2012	09-07B	341935	10802/2012
02-02A	341906	11065/2012	09-07B	341984	11097/2012
02-02A	341907	11066/2012	09-09	341919	13701/2011
02-02A	341908	11067/2012	09-09	341999	13796/2011
02-02A	341909	11068/2012	12-16B	342001	14632/2011
02-02A	341910	11069/2012	12-16B	342002	14635/2011
02-02A	341911	11070/2012	12-16B	342025	14634/2011
02-02A	341912	11071/2012	14-02	341929	11014/2012
02-02A	341913	11072/2012	14-02	341930	11015/2012
02-02A	341914	11073/2012	14-02	341931	11016/2012
02-02A	341915	11074/2012	14-02	341932	10247/2012
02-02C	342006	14823/2011	14-04	341829	11170/2012
02-02C	342007	11873/2012	14-04	341830	11171/2012
02-02C	342009	11875/2012	14-04	341831	11172/2012
02-02C	342012	11878/2012	14-04	341832	11173/2012
02-02C	342013	11879/2012	14-04	341833	11174/2012
02-02NES	341920	10250/2012	14-04	341834	11175/2012
02-02NES	342008	11874/2012	14-04	341835	11176/2012
02-02NES	342010	11876/2012	14-04	341836	11177/2012
02-02NES	342011	11877/2012	14-04	341838	11179/2012
02-04NES	341936	10922/2012	14-04	341843	11180/2012
02-07NES	341876	10560/2012	14-04	341844	11181/2012
05-05NES	341839	10575/2012	14-04	341845	11182/2012
06-03B	341982	10961/2012	14-04	341846	11183/2012
06-04NES	341977	10787/2012	14-04	341847	11184/2012
07-01NES	341935	10802/2012	14-04	341848	11185/2012
07-02NES	341979	10564/2012	14-04	341849	11186/2012
07-02NES	341980	10567/2012	14-04	341851	11188/2012
07-04	341950	10578/2012	14-04	341852	11189/2012
07-04	341951	10579/2012	14-04	341853	11192/2012
07-04	341952	10580/2012	14-04	341854	11195/2012
07-04	341953	10581/2012	14-04	341855	11196/2012
07-04	341954	10582/2012	14-04	341856	11197/2012
07-05NES	341934	10313/2012	14-04	341857	11198/2012
07-05NES	341949	10338/2012	14-04	341858	11199/2012
07-99NES	341840	10894/2012	14-04	341859	11200/2012
08-05P	341877	11458/2012	14-04	341860	11201/2012
08-08F	341934	10313/2012	14-04	341861	11202/2012

Registration Proceedings - Class Listing of Designs Published or Registered cont'd

Classification	Registration Number	Design Number	Classification	Registration Number	Design Number
14-04	341862	11203/2012	14-04	341996	11258/2012
14-04	341863	11204/2012	14-04	341997	11259/2012
14-04	341864	11205/2012	14-04	341998	11260/2012
14-04	341865	11206/2012	14-04	342014	11261/2012
14-04	341866	11222/2012	14-04	342016	11263/2012
14-04	341867	11223/2012	14-04	342017	11264/2012
14-04	341878	11224/2012	14-04	342018	11265/2012
14-04	341879	11225/2012	14-04	342019	11266/2012
14-04	341880	11226/2012	14-04	342020	11267/2012
14-04	341881	11227/2012	14-04	342021	11268/2012
14-04	341882	11228/2012	14-04	342022	11269/2012
14-04	341883	11229/2012	14-04	342023	11270/2012
14-04	341884	11230/2012	14-04	342024	11271/2012
14-04	341885	11231/2012	15-02	341948	10337/2012
14-04	341886	11232/2012	19-02	341868	14643/2011
14-04	341887	11234/2012	19-06	341876	10560/2012
14-04	341888	11235/2012	20-02NES	341874	10559/2012
14-04	341889	11236/2012	20-02NES	341875	11715/2012
14-04	341923	11211/2012	20-02NES	341929	11014/2012
14-04	341924	11212/2012	20-02NES	341930	11015/2012
14-04	341925	11213/2012	20-02NES	341931	11016/2012
14-04	341926	11214/2012	21-02D	342000	14615/2011
14-04	341927	11215/2012	21-02NES	341983	10988/2012
14-04	341938	11216/2012	22-05	341877	11458/2012
14-04	341939	11217/2012	23-01B	341837	11178/2012
14-04	341940	11218/2012	23-01F	341850	11187/2012
14-04	341941	11219/2012	23-01K	341981	10784/2012
14-04	341942	11220/2012	23-02C	341975	10627/2012
14-04	341943	11221/2012	23-02C	341976	11719/2012
14-04	341955	11207/2012	23-02C	342003	14895/2011
14-04	341956	11208/2012	23-02C	342004	14896/2011
14-04	341957	11209/2012	23-02NES	341850	11187/2012
14-04	341958	11210/2012	23-03H	341928	10837/2012
14-04	341960	11237/2012	23-04	341986	10303/2012
14-04	341961	11238/2012	24-01	341828	11168/2012
14-04	341962	11239/2012	24-01	341869	10151/2012
14-04	341963	11240/2012	24-01	341870	11695/2012
14-04	341964	11241/2012	24-01	341871	11696/2012
14-04	341965	11242/2012	24-01	341872	11697/2012
14-04	341966	11243/2012	24-01	341873	11698/2012
14-04	341967	11244/2012	25-01F	341937	11038/2012
14-04	341968	11245/2012	25-01K	341945	11414/2012
14-04	341969	11246/2012	25-01K	341946	11415/2012
14-04	341970	11247/2012	25-01K	341947	11416/2012
14-04	341971	11248/2012	26-06	341922	11474/2012
14-04	341987	11249/2012	26-06	341944	11365/2012
14-04	341988	11250/2012	26-06	341959	11471/2012
14-04	341989	11251/2012	26-06	341978	11519/2012
14-04	341990	11252/2012	28-03D	342005	11428/2012
14-04	341991	11253/2012	31-00	341921	10587/2012
14-04	341992	11254/2012			
14-04	341993	11255/2012			
14-04	341994	11256/2012			

- (21) Design Number: **15623/2011**
(22) Date of Filing Application: **09 December 2011**
(24) Date from which industrial property rights may have effect: **09 December 2011**
(54) Product in respect of which the design is registered: **A tray**
(51) International Design Classification: **09-03F**
(74) Name(s) of Attorney(s): **A J Park**
(71) Name(s) and Address(s) of Applicant(s):
Alto Packaging Limited
Level 6 57 Symonds Street Grafton Auckland 1010 New Zealand
(72) Name(s) of Designer(s): **Ritchie John Williams**
(45) Registration Date: **10 April 2012**
(56) Related Art Documents: **Not Applicable**
(57) Statement of Newness and Distinctiveness: **Newness and distinctiveness resides in the features of shape and/or configuration of a tray substantially as shown in the in the accompanying representations.**

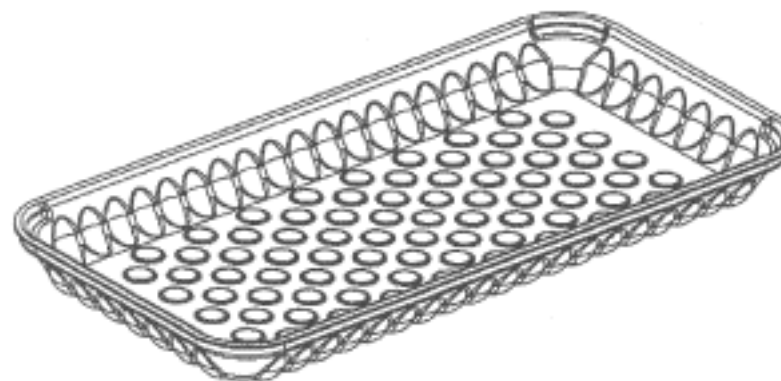

- (21) Design Number: **11168/2012**
(22) Date of Filing Application: **08 March 2012**
(24) Date from which industrial property rights may have effect: **08 March 2012**
(54) Product in respect of which the design is registered: **A patient interface**
(51) International Design Classification: **24-01**
(74) Name(s) of Attorney(s): **Baldwins Intellectual Property**
(71) Name(s) and Address(s) of Applicant(s):
Silas Sao Jin Siew
18 Finbar Close Flat Bush Manukau Auckland 2016 New Zealand
Wen Dong Huang
95 Glenmore Road Pakuranga Auckland 2010 New Zealand
Craig Robert Prentice
9 St Simon Place Botany Downs North Auckland 2010 New Zealand
Andrew Paul Maxwell Salmon
53 Pencarrow Avenue Epsom Auckland 1023 New Zealand
(72) Name(s) of Designer(s): **Silas Sao Jin Siew and Wen Dong Huang and Craig Robert Prentice and Andrew Paul Maxwell Salmon**
(45) Registration Date: **11 April 2012**
(30) Convention priority data:
(31) Number (32) Date (33) Country
29/401,231 08 Sep 2011 UNITED STATES OF AMERICA
(56) Related Art Documents: **Not Applicable**
(57) Statement of Newness and Distinctiveness: **Newness and distinctiveness resides in the shape and configuration of the article as shown in the representations.**

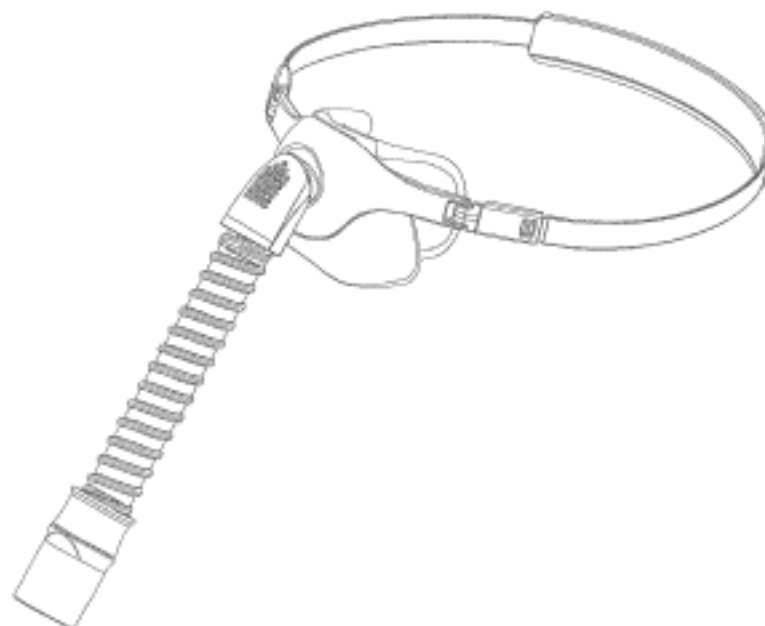

(21) Design Number: **11170/2012**
(22) Date of Filing Application: **07 March 2012**
(24) Date from which industrial property rights may have effect: **07 March 2012**
(54) Product in respect of which the design is registered: **Display screen with icon**
(51) International Design Classification: **14-04**
(74) Name(s) of Attorney(s): **Shelston IP**
(71) Name(s) and Address(s) of Applicant(s):

Microsoft Corporation
One Microsoft Way Redmond Washington 98052 United States of America

(72) Name(s) of Designer(s): **Kieran Phelan**

(45) Registration Date: **11 April 2012**

(30) Convention priority data:

(31) Number	(32) Date	(33) Country
29/401407	12 Sep 2011	UNITED STATES OF AMERICA

(56) Related Art Documents: **Not Applicable**

(57) Statement of Newness and Distinctiveness: **Newness and distinctiveness reside in the pattern and/or ornamentation of a display screen with icon as illustrated by solid lines in the accompanying representations. The features shown in broken outline are for illustrative purposes only and do not form part of the design.**

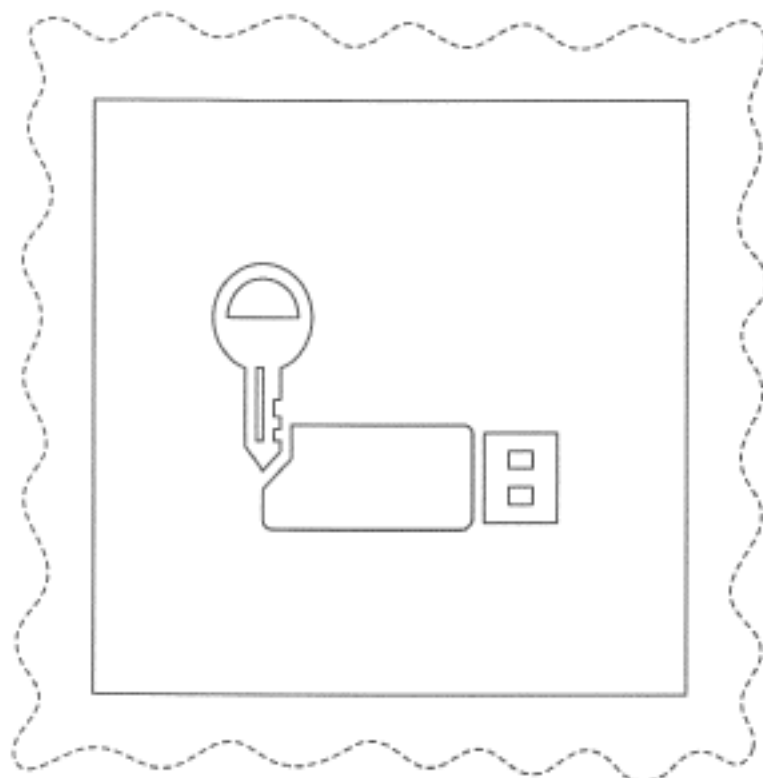

(21) Design Number: **11171/2012**
(22) Date of Filing Application: **07 March 2012**
(24) Date from which industrial property rights may have effect: **07 March 2012**
(54) Product in respect of which the design is registered: **Display Screen with icon**
(51) International Design Classification: **14-04**
(74) Name(s) of Attorney(s): **Shelston IP**
(71) Name(s) and Address(s) of Applicant(s):

Microsoft Corporation
One Microsoft Way Redmond Washington 98052 United States of America

(72) Name(s) of Designer(s): **Kieran Phelan and Patrick Wujcik and Marc Pottier and Michael H. LaManna and Khurram Zia**

(45) Registration Date: **11 April 2012**

(30) Convention priority data:

(31) Number	(32) Date	(33) Country
29/401416	12 Sep 2011	UNITED STATES OF AMERICA

(56) Related Art Documents: **Not Applicable**

(57) Statement of Newness and Distinctiveness: **Newness and distinctiveness reside in the pattern and/or ornamentation of a display screen with icon as illustrated by solid lines in the accompanying representations. The features shown in broken outline are for illustrative purposes only and do not form part of the design.**

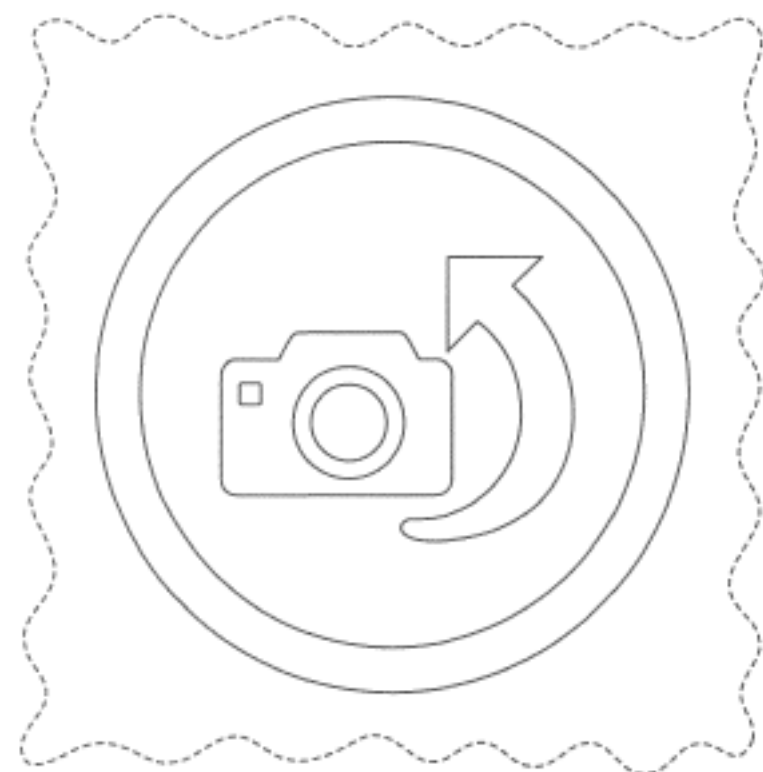

(21) Design Number: **11172/2012**
(22) Date of Filing Application: **07 March 2012**
(24) Date from which industrial property rights may have effect: **07 March 2012**
(54) Product in respect of which the design is registered: **Display screen with icon**
(51) International Design Classification: **14-04**
(74) Name(s) of Attorney(s): **Shelston IP**
(71) Name(s) and Address(s) of Applicant(s):
Microsoft Corporation
One Microsoft Way Redmond Washington 98052 United States of America
(72) Name(s) of Designer(s): **Kieran Phelan and Patrick Wujcik and Marc Pottier and Michael H. LaManna and Khurram Zia**
(45) Registration Date: **11 April 2012**
(30) Convention priority data:
(31) Number (32) Date (33) Country
29/401418 12 Sep 2011 UNITED STATES OF AMERICA
(56) Related Art Documents: **Not Applicable**
(57) Statement of Newness and Distinctiveness: **Newness and distinctiveness reside in the pattern and/or ornamentation of a display screen with icon as illustrated by solid lines in the accompanying representations. The features shown in broken outline are for illustrative purposes only and do not form part of the design.**

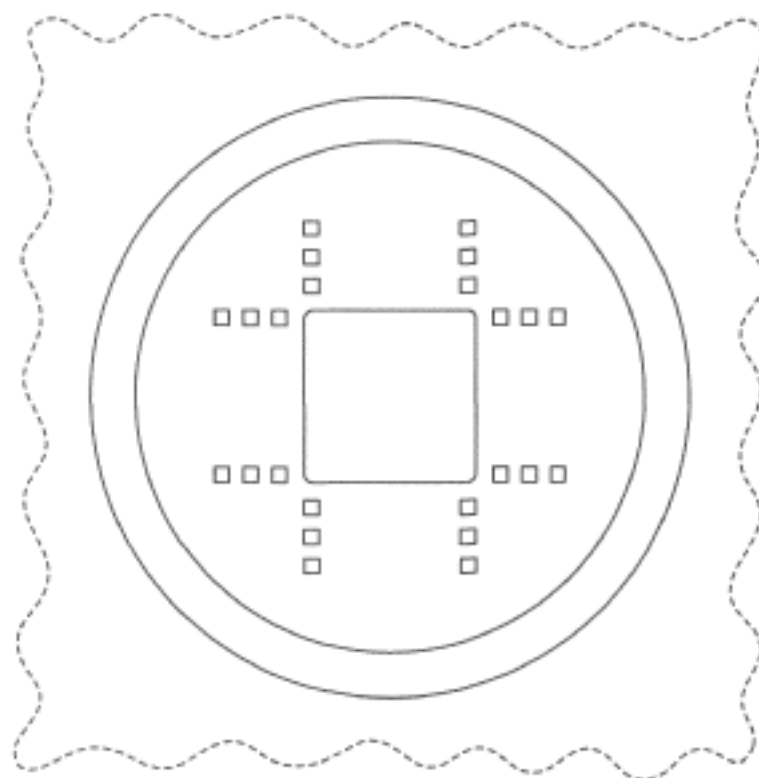

(21) Design Number: **11173/2012**
(22) Date of Filing Application: **07 March 2012**
(24) Date from which industrial property rights may have effect: **07 March 2012**
(54) Product in respect of which the design is registered: **Display screen with icon**
(51) International Design Classification: **14-04**
(74) Name(s) of Attorney(s): **Shelston IP**
(71) Name(s) and Address(s) of Applicant(s):
Microsoft Corporation
One Microsoft Way Redmond Washington 98052 United States of America
(72) Name(s) of Designer(s): **Kieran Phelan and Patrick Wujcik and Marc Pottier and Michael H. LaManna and Khurram Zia**
(45) Registration Date: **11 April 2012**
(30) Convention priority data:
(31) Number (32) Date (33) Country
29/401419 12 Sep 2011 UNITED STATES OF AMERICA
(56) Related Art Documents: **Not Applicable**
(57) Statement of Newness and Distinctiveness: **Newness and distinctiveness reside in the pattern and/or ornamentation of a display screen with icon as illustrated by solid lines in the accompanying representations. The features shown in broken outline are for illustrative purposes only and do not form part of the design.**

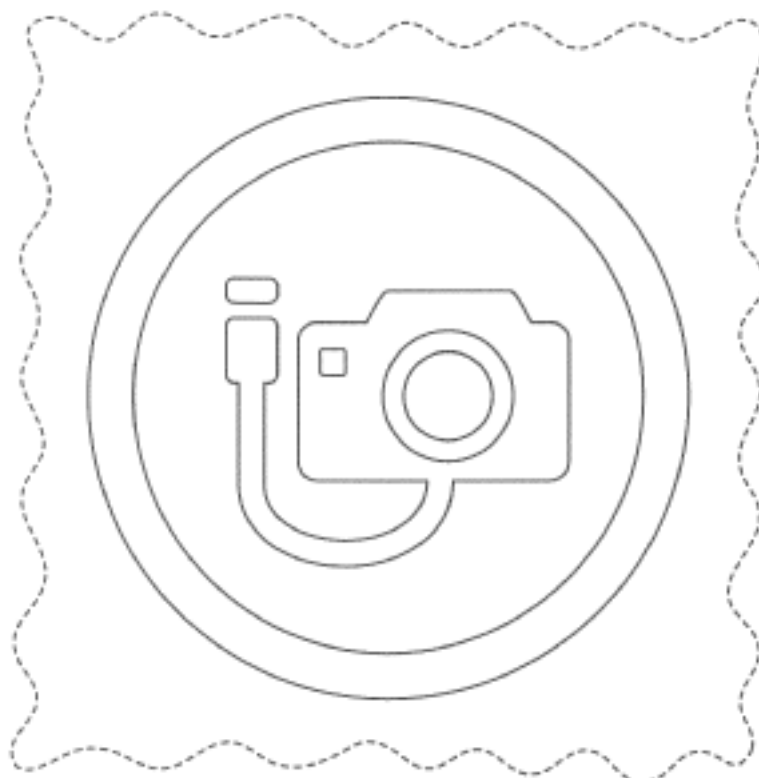

(21) Design Number: **11174/2012**
(22) Date of Filing Application: **07 March 2012**
(24) Date from which industrial property rights may have effect: **07 March 2012**
(54) Product in respect of which the design is registered: **Display screen with icon**
(51) International Design Classification: **14-04**
(74) Name(s) of Attorney(s): **Shelston IP**
(71) Name(s) and Address(s) of Applicant(s):
Microsoft Corporation
One Microsoft Way Redmond Washington 98052 United States of America
(72) Name(s) of Designer(s): **Kieran Phelan and Patrick Wujcik and Marc Pottier and Michael H. LaManna and Khurram Zia**
(45) Registration Date: **11 April 2012**
(30) Convention priority data:
(31) Number (32) Date (33) Country
29/401420 12 Sep 2011 UNITED STATES OF AMERICA
(56) Related Art Documents: **Not Applicable**
(57) Statement of Newness and Distinctiveness: **Newness and distinctiveness reside in the pattern and/or ornamentation of a display screen with icon illustrated by solid lines in the accompanying representations. The features shown in broken outline are for illustrative purposes only and do not form part of the design.**

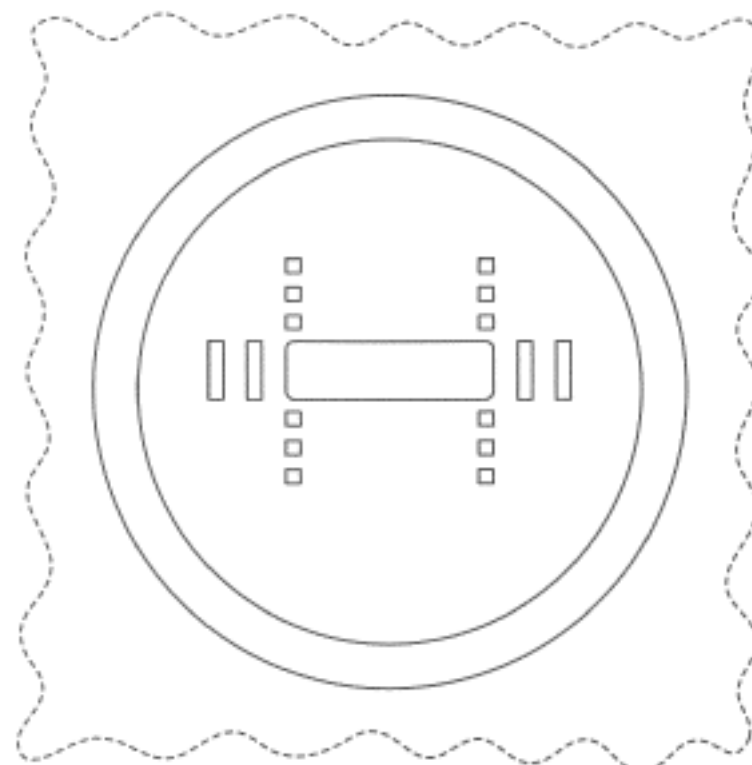

(21) Design Number: **11175/2012**
(22) Date of Filing Application: **07 March 2012**
(24) Date from which industrial property rights may have effect: **07 March 2012**
(54) Product in respect of which the design is registered: **Display screen with icon**
(51) International Design Classification: **14-04**
(74) Name(s) of Attorney(s): **Shelston IP**
(71) Name(s) and Address(s) of Applicant(s):
Microsoft Corporation
One Microsoft Way Redmond Washington 98052 United States of America
(72) Name(s) of Designer(s): **Kieran Phelan and Patrick Wujcik and Marc Pottier and Michael H. LaManna and Khurram Zia**
(45) Registration Date: **11 April 2012**
(30) Convention priority data:
(31) Number (32) Date (33) Country
29/401554 12 Sep 2011 UNITED STATES OF AMERICA
(56) Related Art Documents: **Not Applicable**
(57) Statement of Newness and Distinctiveness: **Newness and distinctiveness reside in the pattern and/or ornamentation of a display screen with icon illustrated by solid lines in the accompanying representations. The features shown in broken outline are for illustrative purposes only and do not form part of the design.**

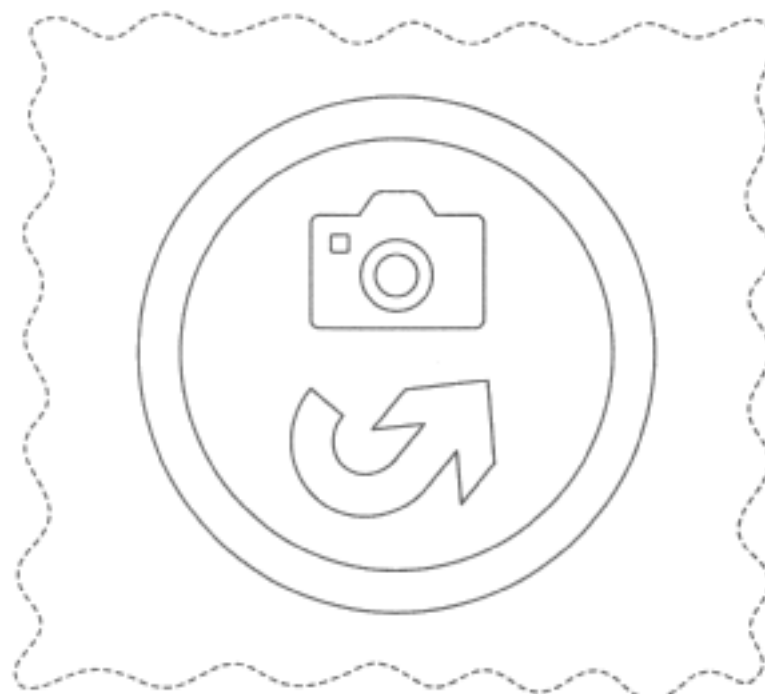

(21) Design Number: **11176/2012**
(22) Date of Filing Application: **07 March 2012**
(24) Date from which industrial property rights may have effect: **07 March 2012**
(54) Product in respect of which the design is registered: **Display screen with icon**
(51) International Design Classification: **14-04**
(74) Name(s) of Attorney(s): **Shelston IP**
(71) Name(s) and Address(s) of Applicant(s):
Microsoft Corporation
One Microsoft Way Redmond Washington 98052 United States of America
(72) Name(s) of Designer(s): **Kieran Phelan and Patrick Wujcik and Marc Pottier and Michael H. LaManna and Khurram Zia**
(45) Registration Date: **11 April 2012**
(30) Convention priority data:
(31) Number (32) Date (33) Country
29/401534 12 Sep 2011 UNITED STATES OF AMERICA
(56) Related Art Documents: **Not Applicable**
(57) Statement of Newness and Distinctiveness: **Newness and distinctiveness reside in the pattern and/or ornamentation of a display screen with icon as illustrated by solid lines in the accompanying representations. The features shown in broken outline are for illustrative purposes only and do not form part of the design.**

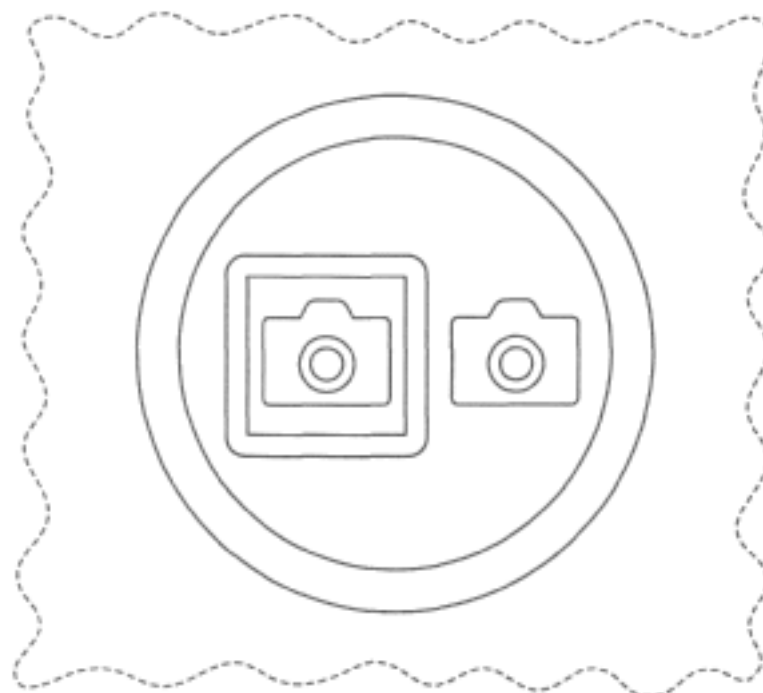

(21) Design Number: **11177/2012**
(22) Date of Filing Application: **07 March 2012**
(24) Date from which industrial property rights may have effect: **07 March 2012**
(54) Product in respect of which the design is registered: **Display screen with icon**
(51) International Design Classification: **14-04**
(74) Name(s) of Attorney(s): **Shelston IP**
(71) Name(s) and Address(s) of Applicant(s):
Microsoft Corporation
One Microsoft Way Redmond Washington 98052 United States of America
(72) Name(s) of Designer(s): **Kieran Phelan**
(45) Registration Date: **11 April 2012**
(30) Convention priority data:
(31) Number (32) Date (33) Country
29/401294 12 Sep 2011 UNITED STATES OF AMERICA
(56) Related Art Documents: **Not Applicable**
(57) Statement of Newness and Distinctiveness: **Newness and distinctiveness reside in the pattern and/or ornamentation of a display screen with icon as illustrated by solid lines in the accompanying representations. The features shown in broken outline are for illustrative purposes only and do not form part of the design.**



(21) Design Number: **11178/2012**
(22) Date of Filing Application: **08 March 2012**
(24) Date from which industrial property rights may have effect: **08 March 2012**
(54) Product in respect of which the design is registered: **Flow shaper for a fire protection sprinkler**
(51) International Design Classification: **23-01B**
(74) Name(s) of Attorney(s): **Shelston IP**
(71) Name(s) and Address(s) of Applicant(s):
The Viking Corporation
210 N. Industrial Park Road Hastings Michigan 49058 United States of America
(72) Name(s) of Designer(s): **Jason Watson**
(45) Registration Date: **11 April 2012**
(30) Convention priority data:
(31) Number (32) Date (33) Country
29/405342 01 Nov 2011 UNITED STATES OF AMERICA
(56) Related Art Documents: **Not Applicable**
(57) Statement of Newness and Distinctiveness: **Newness and distinctiveness resides in the features of shape and configuration of a FLOW SHAPER FOR A FIRE PROTECTION SPRINKLER as illustrated in the accompanying representations.**



(21) Design Number: **11179/2012**
(22) Date of Filing Application: **07 March 2012**
(24) Date from which industrial property rights may have effect: **07 March 2012**
(54) Product in respect of which the design is registered: **Display screen with user interface**
(51) International Design Classification: **14-04**
(74) Name(s) of Attorney(s): **Shelston IP**
(71) Name(s) and Address(s) of Applicant(s):
Microsoft Corporation
One Microsoft Way Redmond Washington 98052 United States of America
(72) Name(s) of Designer(s): **Ethan Nelson Ray**
(45) Registration Date: **11 April 2012**
(30) Convention priority data:
(31) Number (32) Date (33) Country
29/401506 12 Sep 2011 UNITED STATES OF AMERICA
(56) Related Art Documents: **Not Applicable**
(57) Statement of Newness and Distinctiveness: **Newness and distinctiveness reside in the pattern and/or ornamentation of a display screen with user interface as illustrated by solid lines in the accompanying representations. The features shown in broken outline are for illustrative purposes only and do not form part of the design.**

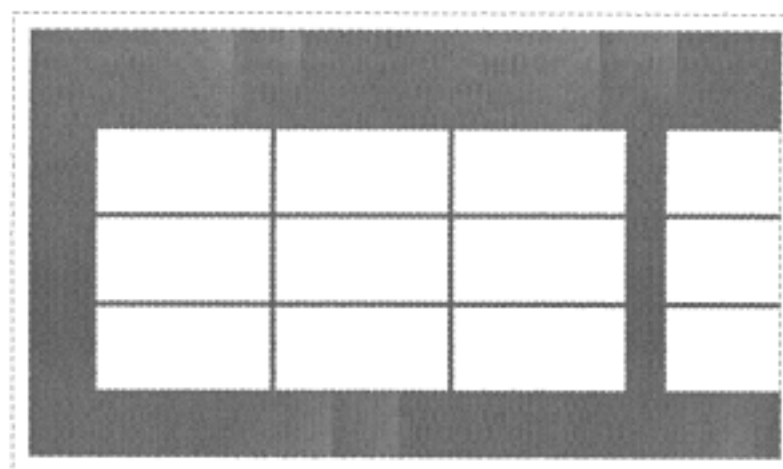

(21) Design Number: **10575/2012**
(22) Date of Filing Application: **07 February 2012**
(24) Date from which industrial property rights may have effect: **07 February 2012**
(54) Product in respect of which the design is registered: **A pattern for textiles**
(51) International Design Classification: **05-05NES**
(74) Name(s) of Attorney(s):
(71) Name(s) and Address(s) of Applicant(s):

The Commonwealth of Australia
C/- Defence Materiel Organisation H4-Victoria Barracks 256-310 St Kilda
Road Melbourne 3006 Australia

(72) Name(s) of Designer(s): **Employees of Cyre Precision LLC**
(45) Registration Date: **12 April 2012**
(56) Related Art Documents: **Not Applicable**
(57) Statement of Newness and Distinctiveness: **Nil**



(21) Design Number: **10894/2012**
(22) Date of Filing Application: **24 February 2012**
(24) Date from which industrial property rights may have effect: **24 February 2012**
(54) Product in respect of which the design is registered: **Hair/lint roller**
(51) International Design Classification: **07-99NES**
(74) Name(s) of Attorney(s): **Griffith Hack**
(71) Name(s) and Address(s) of Applicant(s):

Telebrands Corp.
79 Two Bridges Road Fairfield NJ 07004 United States of America

(72) Name(s) of Designer(s): **Tylor Christian Ross**
(45) Registration Date: **12 April 2012**
(56) Related Art Documents: **Not Applicable**
(57) Statement of Newness and Distinctiveness: **Newness and distinctiveness resides in the visual features, including shape and configuration, of a HAIR/LINT ROLLER as shown in solid outline in the accompanying drawings.**



- (21) Design Number: **11280/2012**
(22) Date of Filing Application: **07 March 2012**
(24) Date from which industrial property rights may have effect: **07 March 2012**
(54) Product in respect of which the design is registered: **Bottle**
(51) International Design Classification: **09-01D**
(74) Name(s) of Attorney(s):
(71) Name(s) and Address(s) of Applicant(s):
Aquaskin Australia Pty Ltd
Suite 402 250 Pitt Street Sydney New South Wales 2000 Australia
(72) Name(s) of Designer(s): **Rocco Vincenzo Panetta**
(45) Registration Date: **12 April 2012**
(56) Related Art Documents: **Not Applicable**
(57) Statement of Newness and Distinctiveness: **Newness and distinctiveness is claimed in the features of shape and/or configuration of a roll up/fold up/collapsible bottle shaped as a pig as illustrated in the accompanying representations.**



- (21) Design Number: **11281/2012**
(22) Date of Filing Application: **07 March 2012**
(24) Date from which industrial property rights may have effect: **07 March 2012**
(54) Product in respect of which the design is registered: **Bottle**
(51) International Design Classification: **09-01D**
(74) Name(s) of Attorney(s):
(71) Name(s) and Address(s) of Applicant(s):
Aquaskin Australia Pty Ltd
Suite 402 250 Pitt Street Sydney New South Wales 2000 Australia
(72) Name(s) of Designer(s): **Rocco Vincenzo Panetta**
(45) Registration Date: **12 April 2012**
(56) Related Art Documents: **Not Applicable**
(57) Statement of Newness and Distinctiveness: **Newness and distinctiveness is claimed in the features of shape and/or configuration of a roll up/fold up/collapsible bottle shaped as a monkey as illustrated in the accompanying representations.**



(21) Design Number: **11180/2012**
(22) Date of Filing Application: **07 March 2012**
(24) Date from which industrial property rights may have effect: **07 March 2012**
(54) Product in respect of which the design is registered: **Display screen with user interface**
(51) International Design Classification: **14-04**
(74) Name(s) of Attorney(s): **Shelston IP**
(71) Name(s) and Address(s) of Applicant(s):
Microsoft Corporation
One Microsoft Way Redmond Washington 98052 United States of America
(72) Name(s) of Designer(s): **Daryl Tanghe and Jennifer Nan and Kieran Phelan**
(45) Registration Date: **12 April 2012**
(30) Convention priority data:
(31) Number (32) Date (33) Country
29/401521 12 Sep 2011 UNITED STATES OF AMERICA
(56) Related Art Documents: **Not Applicable**
(57) Statement of Newness and Distinctiveness: **Newness and distinctiveness reside in the pattern and/or ornamentation of a display screen with user interface illustrated by solid lines in the accompanying representations. The features shown in broken outline are for illustrative purposes only and do not form part of the design.**

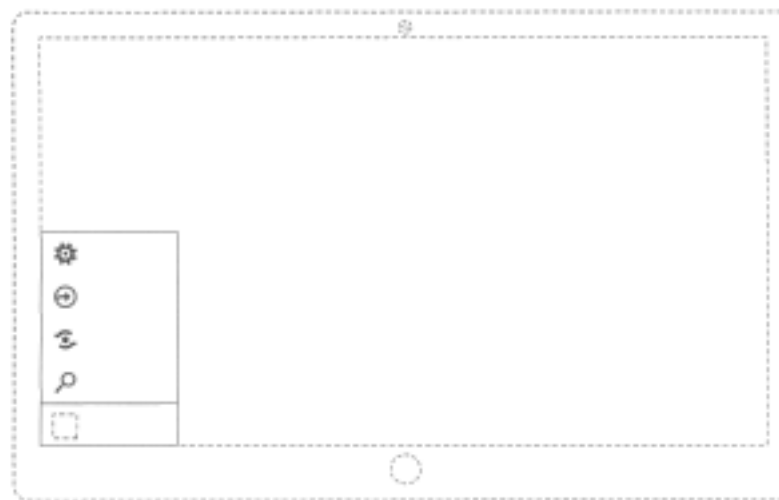

(21) Design Number: **11181/2012**
(22) Date of Filing Application: **07 March 2012**
(24) Date from which industrial property rights may have effect: **07 March 2012**
(54) Product in respect of which the design is registered: **Display screen with user interface**
(51) International Design Classification: **14-04**
(74) Name(s) of Attorney(s): **Shelston IP**
(71) Name(s) and Address(s) of Applicant(s):
Microsoft Corporation
One Microsoft Way Redmond Washington 98052 United States of America
(72) Name(s) of Designer(s): **Brian Shawn LeVee and Jesse Clay Satterfield**
(45) Registration Date: **12 April 2012**
(30) Convention priority data:
(31) Number (32) Date (33) Country
29/401473 12 Sep 2011 UNITED STATES OF AMERICA
(56) Related Art Documents: **Not Applicable**
(57) Statement of Newness and Distinctiveness: **Newness and distinctiveness reside in the pattern and/or ornamentation of a display screen with user interface illustrated by solid lines in the accompanying representations. The features shown in broken outline are for illustrative purposes only and do not form part of the design.**

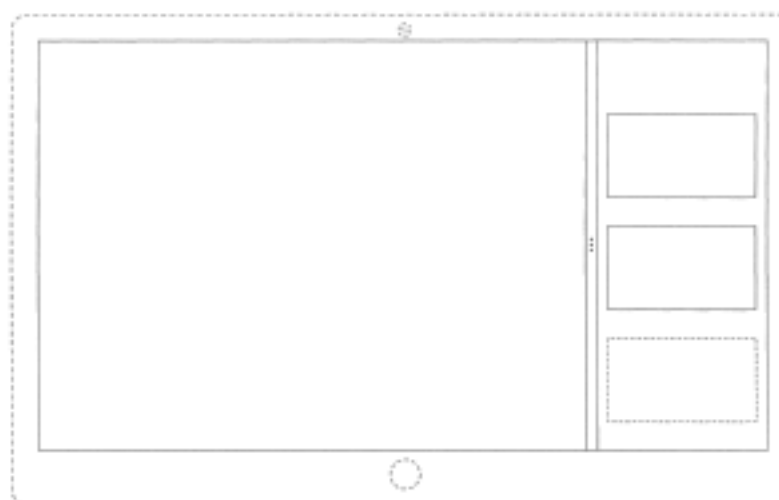

- (21) Design Number: **11182/2012**
(22) Date of Filing Application: **07 March 2012**
(24) Date from which industrial property rights may have effect: **07 March 2012**
(54) Product in respect of which the design is registered: **Display screen with user interface**
(51) International Design Classification: **14-04**
(74) Name(s) of Attorney(s): **Shelston IP**
(71) Name(s) and Address(s) of Applicant(s):
Microsoft Corporation
One Microsoft Way Redmond Washington 98052 United States of America
(72) Name(s) of Designer(s): **Holger Kuhnle and Tsz Yan Wong and Ethan Nelson Ray and Denise Michele Trabona and Heiwad Hamidy Osman and Daryl Tanghe**
(45) Registration Date: **12 April 2012**
(30) Convention priority data:
(31) Number (32) Date (33) Country
29/401472 12 Sep 2011 UNITED STATES OF AMERICA
(56) Related Art Documents: **Not Applicable**
(57) Statement of Newness and Distinctiveness: **Newness and distinctiveness reside in the pattern and/or ornamentation of a display screen with user interface illustrated by solid lines in the accompanying representations. The features shown in broken outline are for illustrative purposes only and do not form part of the design.**

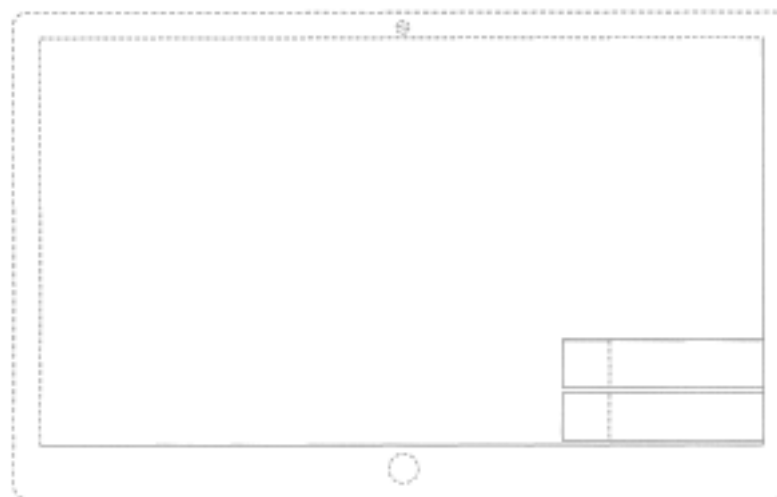

- (21) Design Number: **11183/2012**
(22) Date of Filing Application: **07 March 2012**
(24) Date from which industrial property rights may have effect: **07 March 2012**
(54) Product in respect of which the design is registered: **Display screen with user interface**
(51) International Design Classification: **14-04**
(74) Name(s) of Attorney(s): **Shelston IP**
(71) Name(s) and Address(s) of Applicant(s):
Microsoft Corporation
One Microsoft Way Redmond Washington 98052 United States of America
(72) Name(s) of Designer(s): **Holger Kuhnle and Tsz Yan Wong and Ethan Nelson Ray and Denise Michele Trabona and Heiwad Hamidy Osman and Daryl Tanghe**
(45) Registration Date: **12 April 2012**
(30) Convention priority data:
(31) Number (32) Date (33) Country
29/401551 12 Sep 2011 UNITED STATES OF AMERICA
(56) Related Art Documents: **Not Applicable**
(57) Statement of Newness and Distinctiveness: **Newness and distinctiveness reside in the pattern and/or ornamentation of a display screen with user interface as illustrated by solid lines in the accompanying representations. The features shown in broken outline are for illustrative purposes only and do not form part of the design.**

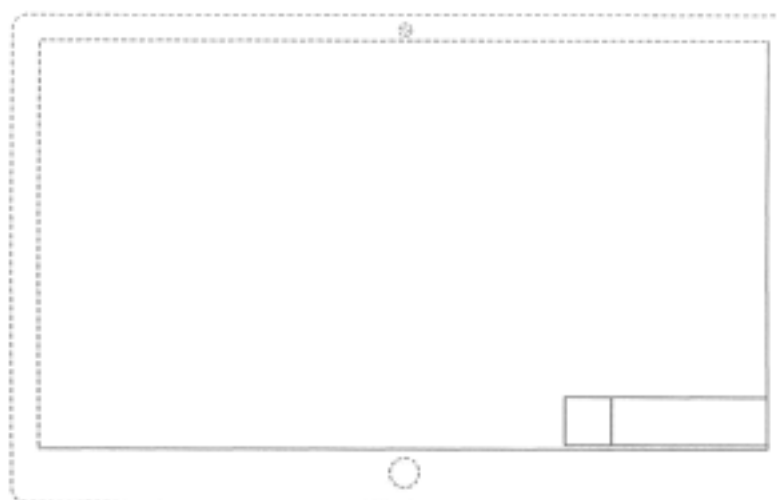

(21) Design Number: **11184/2012**
(22) Date of Filing Application: **07 March 2012**
(24) Date from which industrial property rights may have effect: **07 March 2012**
(54) Product in respect of which the design is registered: **Display screen with icon**
(51) International Design Classification: **14-04**
(74) Name(s) of Attorney(s): **Shelston IP**
(71) Name(s) and Address(s) of Applicant(s):

Microsoft Corporation
One Microsoft Way Redmond Washington 98052 United States of America

(72) Name(s) of Designer(s): **Kieran Phelan**

(45) Registration Date: **12 April 2012**

(30) Convention priority data:

(31) Number	(32) Date	(33) Country
29/401550	12 Sep 2011	UNITED STATES OF AMERICA

(56) Related Art Documents: **Not Applicable**

(57) Statement of Newness and Distinctiveness: **Newness and distinctiveness reside in the pattern and/or ornamentation of a display screen with icon as illustrated by solid lines in the accompanying representations. The features shown in broken outline are for illustrative purposes only and do not form part of the design.**

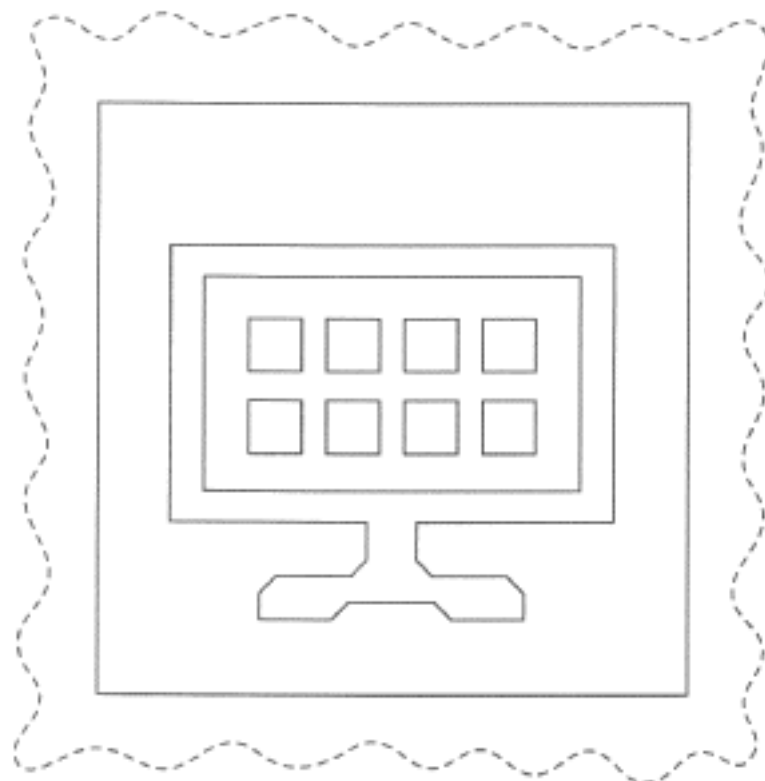

(21) Design Number: **11185/2012**
(22) Date of Filing Application: **07 March 2012**
(24) Date from which industrial property rights may have effect: **07 March 2012**
(54) Product in respect of which the design is registered: **Display screen with icon**
(51) International Design Classification: **14-04**
(74) Name(s) of Attorney(s): **Shelston IP**
(71) Name(s) and Address(s) of Applicant(s):

Microsoft Corporation
One Microsoft Way Redmond Washington 98052 United States of America

(72) Name(s) of Designer(s): **Kieran Phelan**

(45) Registration Date: **12 April 2012**

(30) Convention priority data:

(31) Number	(32) Date	(33) Country
29/401394	12 Sep 2011	UNITED STATES OF AMERICA

(56) Related Art Documents: **Not Applicable**

(57) Statement of Newness and Distinctiveness: **Newness and distinctiveness reside in the pattern and/or ornamentation of a display screen with icon as illustrated by solid lines in the accompanying representations. The features shown in broken outline are for illustrative purposes only and do not form part of the design.**

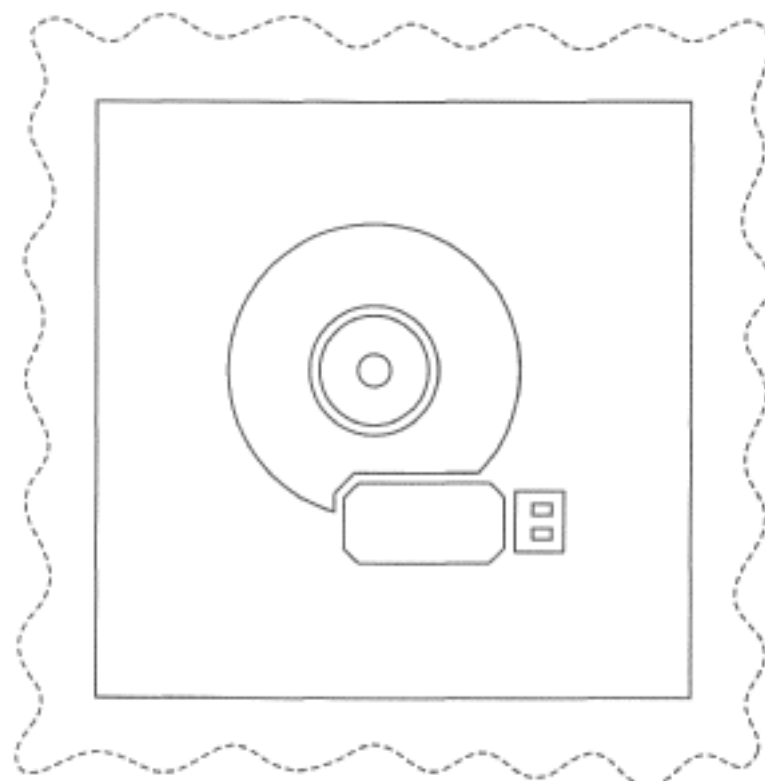

(21) Design Number: **11186/2012**
(22) Date of Filing Application: **07 March 2012**
(24) Date from which industrial property rights may have effect: **07 March 2012**
(54) Product in respect of which the design is registered: **Display screen with icon**
(51) International Design Classification: **14-04**
(74) Name(s) of Attorney(s): **Shelston IP**
(71) Name(s) and Address(s) of Applicant(s):

Microsoft Corporation
One Microsoft Way Redmond Washington 98052 United States of America

(72) Name(s) of Designer(s): **Kieran Phelan and Travis Eby and Patrick Wujcik**
(45) Registration Date: **12 April 2012**

(30) Convention priority data:

(31) Number	(32) Date	(33) Country
29/401411	12 Sep 2011	UNITED STATES OF AMERICA

(56) Related Art Documents: **Not Applicable**

(57) Statement of Newness and Distinctiveness: **Newness and distinctiveness reside in the pattern and/or ornamentation of a display screen with icon as illustrated by solid lines in the accompanying representations. The features shown in broken outline are for illustrative purposes only and do not form part of the design.**

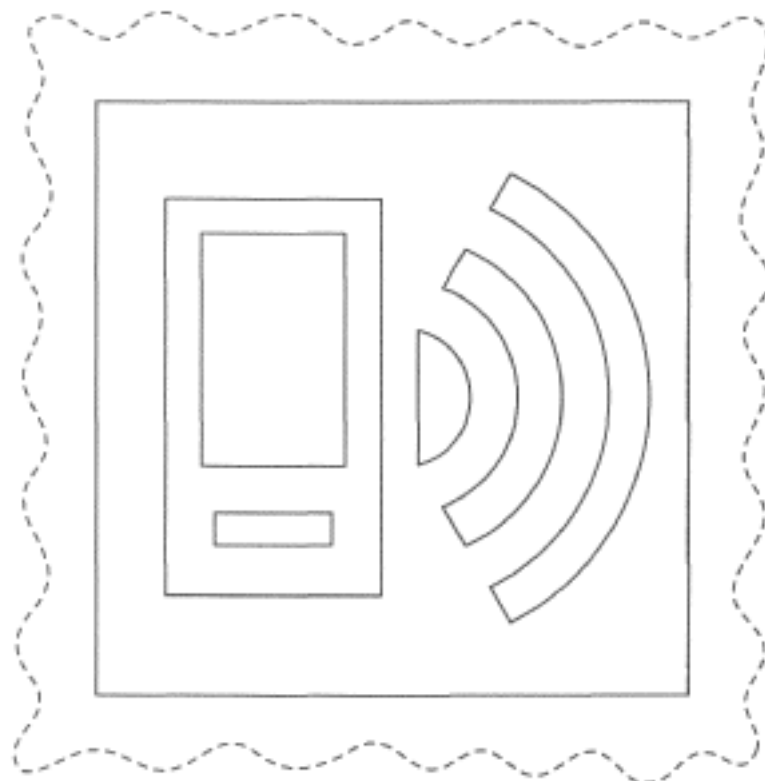

(21) Design Number: **11187/2012**
(22) Date of Filing Application: **08 March 2012**
(24) Date from which industrial property rights may have effect: **08 March 2012**
(54) Product in respect of which the design is registered: **A tank**
(51) International Design Classification: **23-02NES, 23-01F**
(74) Name(s) of Attorney(s): **Fisher Adams Kelly**
(71) Name(s) and Address(s) of Applicant(s):

Warren Environmental, Inc
PO Box 1206 Carver 02330 Massachusetts United States of America

(72) Name(s) of Designer(s): **Danny Warren**

(45) Registration Date: **12 April 2012**

(56) Related Art Documents: **Not Applicable**

(57) Statement of Newness and Distinctiveness: **The newness and distinctiveness of the design resides in the shape and/or configuration of A Tank shown in the representations.**

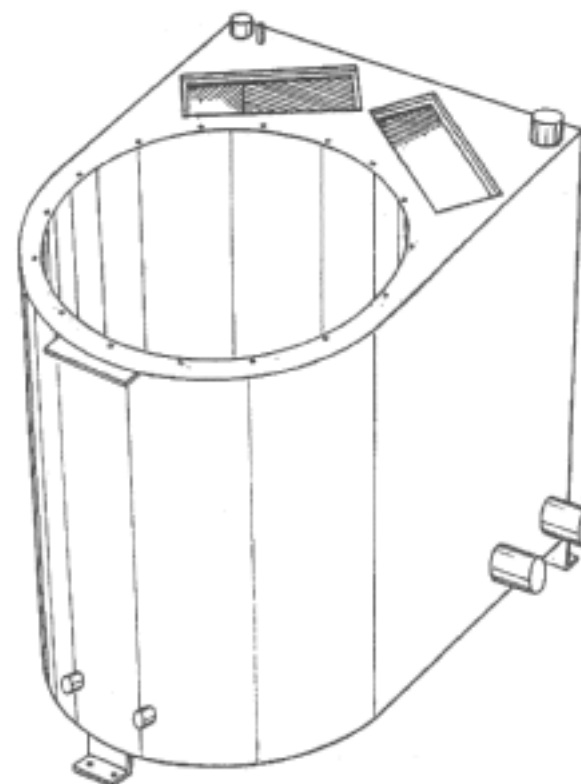

(21) Design Number: **11188/2012**
(22) Date of Filing Application: **07 March 2012**
(24) Date from which industrial property rights may have effect: **07 March 2012**
(54) Product in respect of which the design is registered: **Display screen with icon**
(51) International Design Classification: **14-04**
(74) Name(s) of Attorney(s): **Shelston IP**
(71) Name(s) and Address(s) of Applicant(s):
Microsoft Corporation
One Microsoft Way Redmond Washington 98052 United States of America
(72) Name(s) of Designer(s): **Kieran Phelan and Patrick Wujcik and Marc Pottier and Michael H. LaManna and Khurram Zia**
(45) Registration Date: **12 April 2012**
(30) Convention priority data:
(31) Number (32) Date (33) Country
29/401414 12 Sep 2011 UNITED STATES OF AMERICA
(56) Related Art Documents: **Not Applicable**
(57) Statement of Newness and Distinctiveness: **Newness and distinctiveness reside in the pattern and/or ornamentation of a display screen with icon as illustrated by solid lines in the accompanying representations. The features shown in broken outline are for illustrative purposes only and do not form any part of the design.**

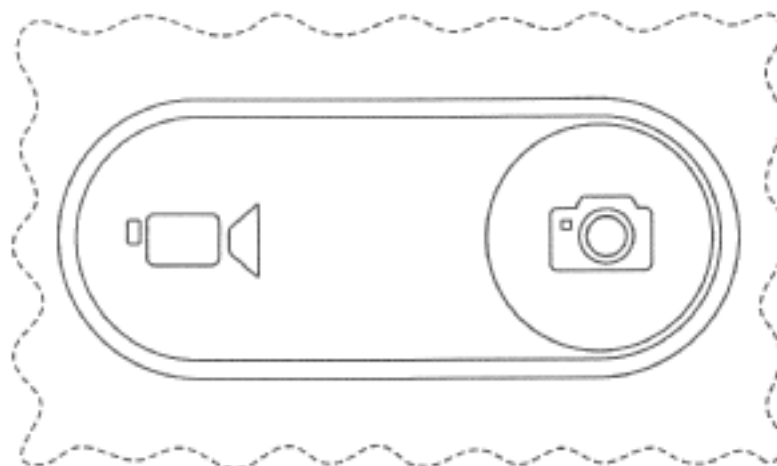

(21) Design Number: **11189/2012**
(22) Date of Filing Application: **07 March 2012**
(24) Date from which industrial property rights may have effect: **07 March 2012**
(54) Product in respect of which the design is registered: **Display screen with icon**
(51) International Design Classification: **14-04**
(74) Name(s) of Attorney(s): **Shelston IP**
(71) Name(s) and Address(s) of Applicant(s):
Microsoft Corporation
One Microsoft Way Redmond Washington 98052 United States of America
(72) Name(s) of Designer(s): **Kieran Phelan and Patrick Wujcik and Marc Pottier and Michael H. LaManna and Khurram Zia**
(45) Registration Date: **12 April 2012**
(30) Convention priority data:
(31) Number (32) Date (33) Country
29/401415 12 Sep 2011 UNITED STATES OF AMERICA
(56) Related Art Documents: **Not Applicable**
(57) Statement of Newness and Distinctiveness: **Newness and distinctiveness reside in the pattern and/or ornamentation of a display screen with icon as illustrated by solid lines in the accompanying representations. The features shown in broken outline are for illustrative purposes only and do not form any part of the design.**

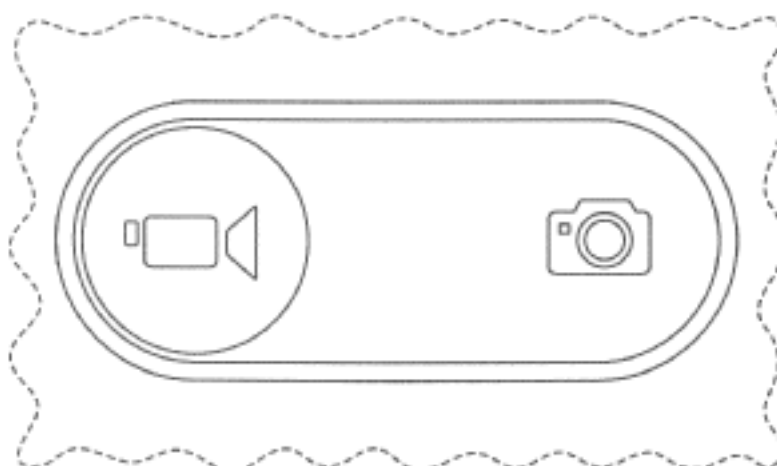

- (21) Design Number: **11192/2012**
(22) Date of Filing Application: **07 March 2012**
(24) Date from which industrial property rights may have effect: **07 March 2012**
(54) Product in respect of which the design is registered: **Display screen with user interface**
(51) International Design Classification: **14-04**
(74) Name(s) of Attorney(s): **Shelston IP**
(71) Name(s) and Address(s) of Applicant(s):
Microsoft Corporation
One Microsoft Way Redmond Washington 98052 United States of America
(72) Name(s) of Designer(s): **Patrick Wujcik and Marc Pottier and Michael H. LaManna and Khurram Zia and Catherine White and Samuel Moreau**
(45) Registration Date: **12 April 2012**
(30) Convention priority data:
(31) Number (32) Date (33) Country
29/401462 12 Sep 2011 UNITED STATES OF AMERICA
(56) Related Art Documents: **Not Applicable**
(57) Statement of Newness and Distinctiveness: **Newness and distinctiveness reside in the pattern and/or ornamentation of a display screen with user interface as illustrated by solid lines in the accompanying representations. The features shown in broken outline are for illustrative purposes only and do not form any part of the design.**

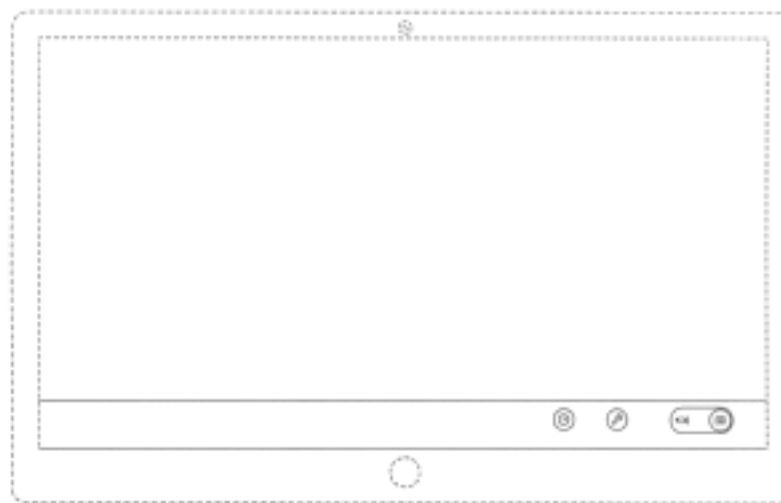

- (21) Design Number: **11195/2012**
(22) Date of Filing Application: **07 March 2012**
(24) Date from which industrial property rights may have effect: **07 March 2012**
(54) Product in respect of which the design is registered: **Display screen with icon**
(51) International Design Classification: **14-04**
(74) Name(s) of Attorney(s): **Shelston IP**
(71) Name(s) and Address(s) of Applicant(s):
Microsoft Corporation
One Microsoft Way Redmond Washington 98052 United States of America
(72) Name(s) of Designer(s): **Kieran Phelan**
(45) Registration Date: **12 April 2012**
(30) Convention priority data:
(31) Number (32) Date (33) Country
29/401389 12 Sep 2011 UNITED STATES OF AMERICA
(56) Related Art Documents: **Not Applicable**
(57) Statement of Newness and Distinctiveness: **Newness and distinctiveness reside in the pattern and/or ornamentation of a display screen with icon as illustrated by solid lines in the accompanying representations. The features shown in broken outline are for illustrative purposes only and do not form any part of the design.**

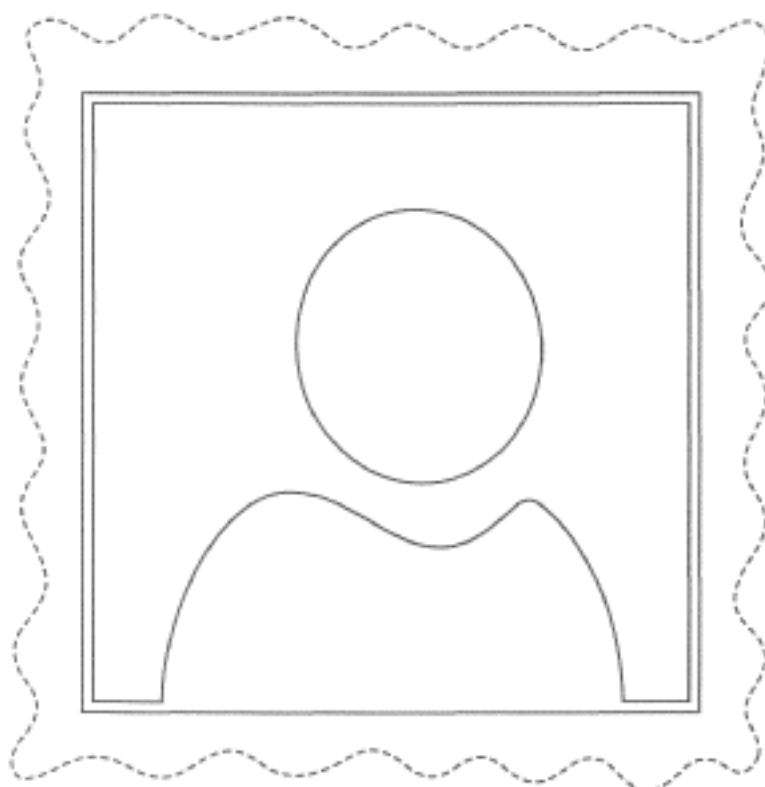

(21) Design Number: **11196/2012**
(22) Date of Filing Application: **07 March 2012**
(24) Date from which industrial property rights may have effect: **07 March 2012**
(54) Product in respect of which the design is registered: **Display screen with icon set**
(51) International Design Classification: **14-04**
(74) Name(s) of Attorney(s): **Shelston IP**
(71) Name(s) and Address(s) of Applicant(s):
Microsoft Corporation
One Microsoft Way Redmond Washington 98052 United States of America
(72) Name(s) of Designer(s): **Kieran Phelan**
(45) Registration Date: **12 April 2012**
(30) Convention priority data:
(31) Number (32) Date (33) Country
29/401467 12 Sep 2011 UNITED STATES OF AMERICA
(56) Related Art Documents: **Not Applicable**
(57) Statement of Newness and Distinctiveness: **Newness and distinctiveness reside in the pattern and/or ornamentation of a display screen with icon set as illustrated by solid lines in the accompanying representations. The features shown in broken outline are for illustrative purposes only and do not form any part of the design.**

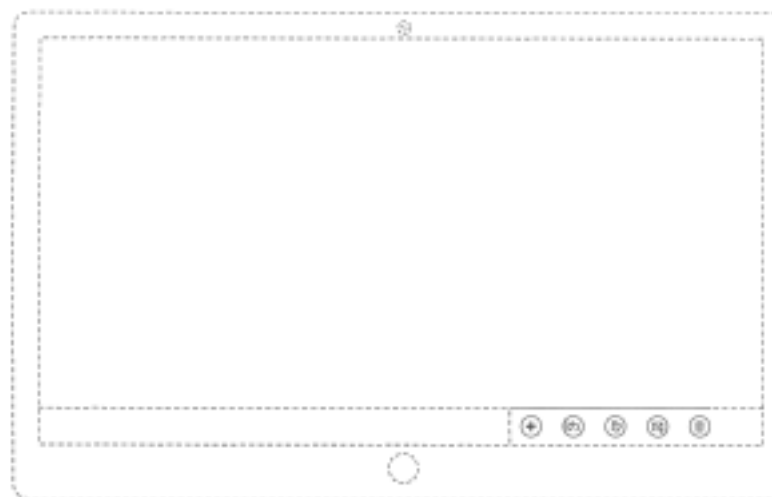

(21) Design Number: **11197/2012**
(22) Date of Filing Application: **07 March 2012**
(24) Date from which industrial property rights may have effect: **07 March 2012**
(54) Product in respect of which the design is registered: **Display screen with user interface**
(51) International Design Classification: **14-04**
(74) Name(s) of Attorney(s): **Shelston IP**
(71) Name(s) and Address(s) of Applicant(s):
Microsoft Corporation
One Microsoft Way Redmond Washington 98052 United States of America
(72) Name(s) of Designer(s): **Zachary J. Shallcross and Mirko Mandic and Lindsey R. Barcheck**
(45) Registration Date: **13 April 2012**
(30) Convention priority data:
(31) Number (32) Date (33) Country
29/401474 12 Sep 2011 UNITED STATES OF AMERICA
(56) Related Art Documents: **Not Applicable**
(57) Statement of Newness and Distinctiveness: **Newness and distinctiveness reside in the pattern and/or ornamentation of a display screen with user interface as illustrated by solid lines in the accompanying representations. The features shown in broken outline are for illustrative purposes only and do not form part of the design.**

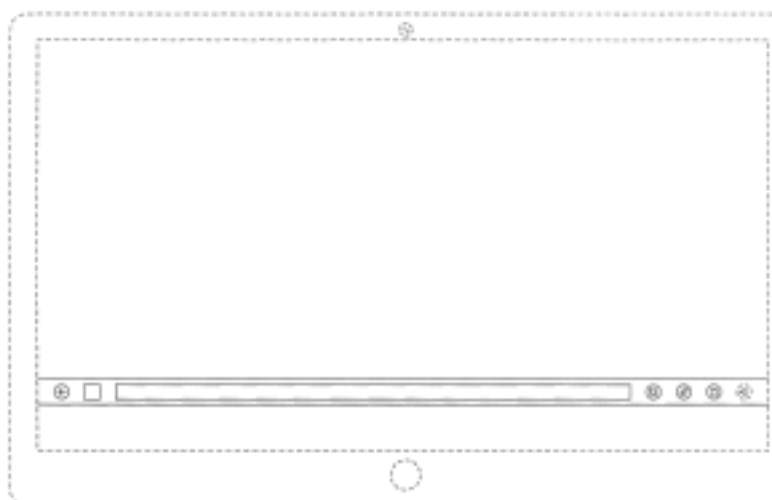

(21) Design Number: **11198/2012**
(22) Date of Filing Application: **07 March 2012**
(24) Date from which industrial property rights may have effect: **07 March 2012**
(54) Product in respect of which the design is registered: **Display screen with user interface**
(51) International Design Classification: **14-04**
(74) Name(s) of Attorney(s): **Shelston IP**
(71) Name(s) and Address(s) of Applicant(s):
Microsoft Corporation
One Microsoft Way Redmond Washington 98052 United States of America
(72) Name(s) of Designer(s): **Zachary J. Shallcross and Mirko Mandic**
(45) Registration Date: **13 April 2012**
(30) Convention priority data:
(31) Number (32) Date (33) Country
29/401471 12 Sep 2011 UNITED STATES OF AMERICA
(56) Related Art Documents: **Not Applicable**
(57) Statement of Newness and Distinctiveness: **Newness and distinctiveness reside in the pattern and/or ornamentation of a display screen with user interface as illustrated by solid lines in the accompanying representations. The features shown in broken outline are for illustrative purposes only and do not form part of the design.**

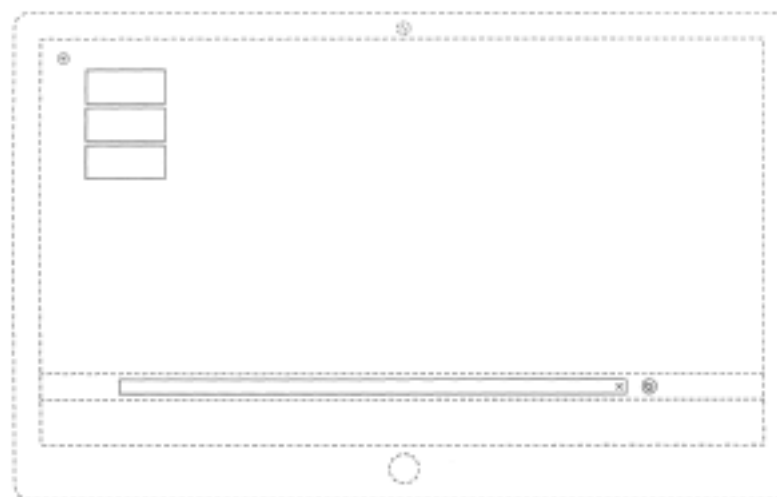

(21) Design Number: **11199/2012**
(22) Date of Filing Application: **07 March 2012**
(24) Date from which industrial property rights may have effect: **07 March 2012**
(54) Product in respect of which the design is registered: **Display screen with user interface**
(51) International Design Classification: **14-04**
(74) Name(s) of Attorney(s): **Shelston IP**
(71) Name(s) and Address(s) of Applicant(s):
Microsoft Corporation
One Microsoft Way Redmond Washington 98052 United States of America
(72) Name(s) of Designer(s): **David Premalini and Ismail Nithin**
(45) Registration Date: **13 April 2012**
(30) Convention priority data:
(31) Number (32) Date (33) Country
29/401547 12 Sep 2011 UNITED STATES OF AMERICA
(56) Related Art Documents: **Not Applicable**
(57) Statement of Newness and Distinctiveness: **Newness and distinctiveness reside in the pattern and/or ornamentation of a display screen with user interface as illustrated by solid lines in the accompanying representations. The features shown in broken outline are for illustrative purposes only and do not form part of the design.**

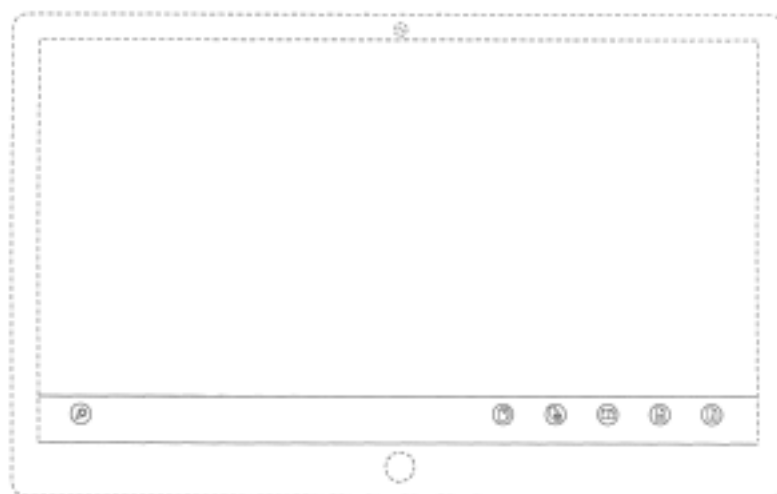

(21) Design Number: **11200/2012**
(22) Date of Filing Application: **07 March 2012**
(24) Date from which industrial property rights may have effect: **07 March 2012**
(54) Product in respect of which the design is registered: **Display screen with user interface**
(51) International Design Classification: **14-04**
(74) Name(s) of Attorney(s): **Shelston IP**
(71) Name(s) and Address(s) of Applicant(s):
Microsoft Corporation
One Microsoft Way Redmond Washington 98052 United States of America
(72) Name(s) of Designer(s): **Nithin Ismail and Kanna Ramasubramanian**
(45) Registration Date: **13 April 2012**
(30) Convention priority data:
(31) Number (32) Date (33) Country
29/401477 12 Sep 2011 UNITED STATES OF AMERICA
(56) Related Art Documents: **Not Applicable**
(57) Statement of Newness and Distinctiveness: **Newness and distinctiveness reside in the pattern and/or ornamentation of a display screen with user interface as illustrated by solid lines in the accompanying representations. The features shown in broken outline are for illustrative purposes only and do not form part of the design.**

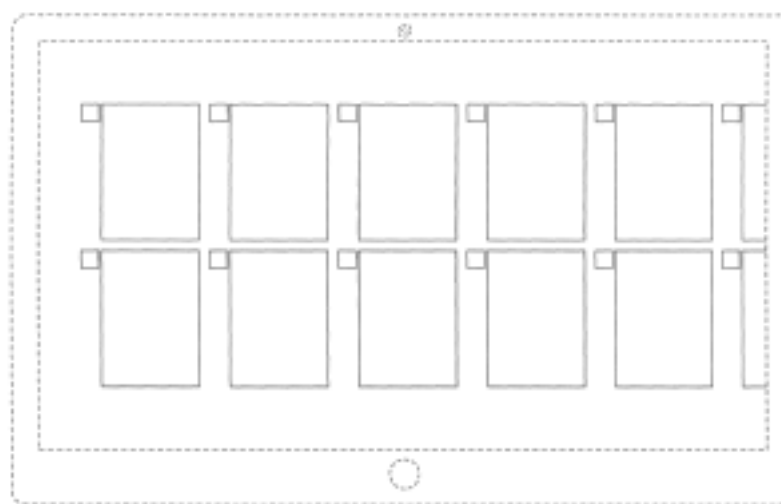

(21) Design Number: **11201/2012**
(22) Date of Filing Application: **07 March 2012**
(24) Date from which industrial property rights may have effect: **07 March 2012**
(54) Product in respect of which the design is registered: **Display screen with icon**
(51) International Design Classification: **14-04**
(74) Name(s) of Attorney(s): **Shelston IP**
(71) Name(s) and Address(s) of Applicant(s):
Microsoft Corporation
One Microsoft Way Redmond Washington 98052 United States of America
(72) Name(s) of Designer(s): **Kieran Phelan**
(45) Registration Date: **13 April 2012**
(30) Convention priority data:
(31) Number (32) Date (33) Country
29/401437 12 Sep 2011 UNITED STATES OF AMERICA
(56) Related Art Documents: **Not Applicable**
(57) Statement of Newness and Distinctiveness: **Newness and distinctiveness reside in the pattern and/or ornamentation of a display screen with icon as illustrated by solid lines in the accompanying representations. The features shown in broken outline are for illustrative purposes only and do not form part of the design.**

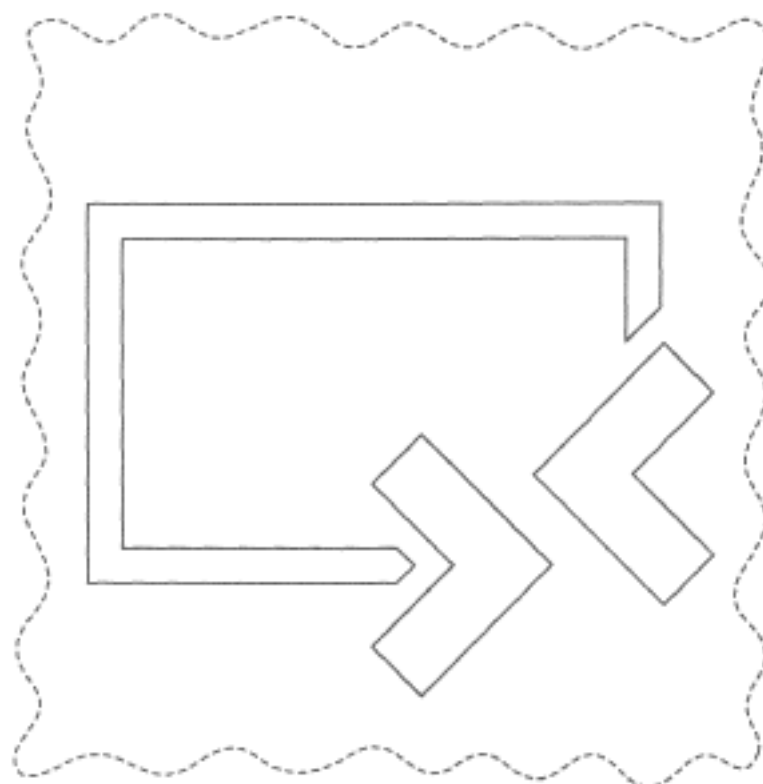

- (21) Design Number: **11202/2012**
- (22) Date of Filing Application: **07 March 2012**
- (24) Date from which industrial property rights may have effect: **07 March 2012**
- (54) Product in respect of which the design is registered: **Display screen with user interface**
- (51) International Design Classification: **14-04**
- (74) Name(s) of Attorney(s): **Shelston IP**
- (71) Name(s) and Address(s) of Applicant(s):
Microsoft Corporation
One Microsoft Way Redmond Washington 98052 United States of America
- (72) Name(s) of Designer(s): **Karen K. Wong and Leslie Christine MacNeil and Kuei-Chih Sun and Caitlin Kehoe and Derek Scott Armstrong McNeill and Gerrit Hofmeister**
- (45) Registration Date: **13 April 2012**
- (30) Convention priority data:

(31) Number	(32) Date	(33) Country
29/401476	12 Sep 2011	UNITED STATES OF AMERICA
- (56) Related Art Documents: **Not Applicable**
- (57) Statement of Newness and Distinctiveness: **Newness and distinctiveness reside in the pattern and/or ornamentation of a display screen with user interface as illustrated by solid lines in the accompanying representations. The features shown in broken outline are for illustrative purposes only and do not form part of the design.**

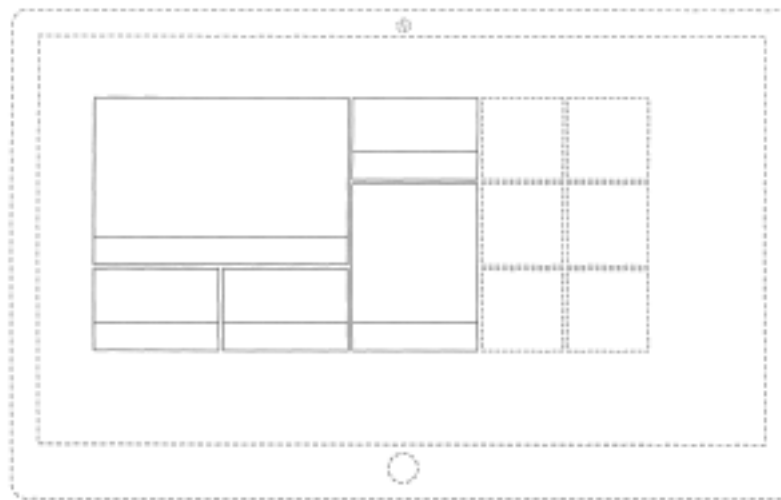

- (21) Design Number: **11203/2012**
- (22) Date of Filing Application: **07 March 2012**
- (24) Date from which industrial property rights may have effect: **07 March 2012**
- (54) Product in respect of which the design is registered: **Display screen with user interface**
- (51) International Design Classification: **14-04**
- (74) Name(s) of Attorney(s): **Shelston IP**
- (71) Name(s) and Address(s) of Applicant(s):
Microsoft Corporation
One Microsoft Way Redmond Washington 98052 United States of America
- (72) Name(s) of Designer(s): **Zachary J. Shallcross and Mirko Mandic and Lindsey R. Barcheck and Michael John Patten and Marty J. Hall and Mary-Lynne Williams and Ian Hyun Sun Kim and Roger William Benson**
- (45) Registration Date: **13 April 2012**
- (30) Convention priority data:

(31) Number	(32) Date	(33) Country
29/401475	12 Sep 2011	UNITED STATES OF AMERICA
- (56) Related Art Documents: **Not Applicable**
- (57) Statement of Newness and Distinctiveness: **Newness and distinctiveness reside in the pattern and/or ornamentation of a display screen with user interface as illustrated by solid lines in the accompanying representations. The features shown in broken outline are for illustrative purposes only and do not form part of the design.**



- (21) Design Number: **11204/2012**
(22) Date of Filing Application: **07 March 2012**
(24) Date from which industrial property rights may have effect: **07 March 2012**
(54) Product in respect of which the design is registered: **Display screen with user interface**
(51) International Design Classification: **14-04**
(74) Name(s) of Attorney(s): **Shelston IP**
(71) Name(s) and Address(s) of Applicant(s):
Microsoft Corporation
One Microsoft Way Redmond Washington 98052 United States of America
(72) Name(s) of Designer(s): **Lisa Carolyn Cherian and Alton Kwok and Gerrit Hofmeester and Orry Wijanarko Soegiono**
(45) Registration Date: **13 April 2012**
(30) Convention priority data:
(31) Number (32) Date (33) Country
29/401461 12 Sep 2011 UNITED STATES OF AMERICA
(56) Related Art Documents: **Not Applicable**
(57) Statement of Newness and Distinctiveness: **Newness and distinctiveness reside in the pattern and/or ornamentation of a display screen with user interface as illustrated by solid lines in the accompanying representations. The features shown in broken outline are for illustrative purposes only and do not form part of the design.**

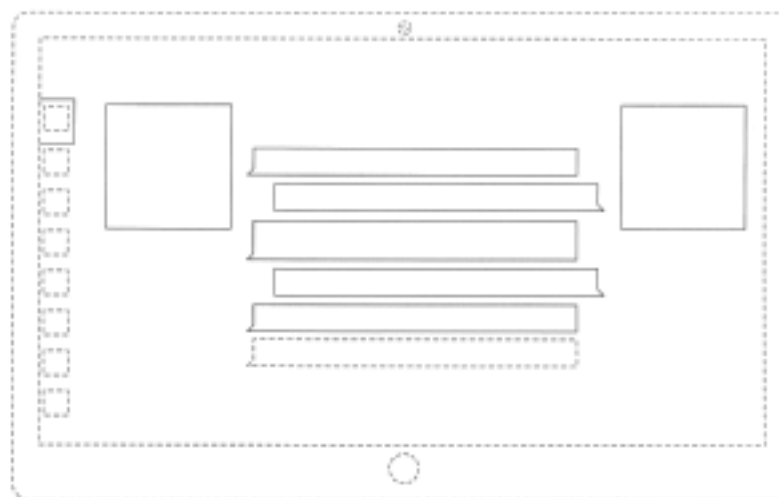

- (21) Design Number: **11205/2012**
(22) Date of Filing Application: **07 March 2012**
(24) Date from which industrial property rights may have effect: **07 March 2012**
(54) Product in respect of which the design is registered: **Display screen with user interface**
(51) International Design Classification: **14-04**
(74) Name(s) of Attorney(s): **Shelston IP**
(71) Name(s) and Address(s) of Applicant(s):
Microsoft Corporation
One Microsoft Way Redmond Washington 98052 United States of America
(72) Name(s) of Designer(s): **Daryl Tanghe and Priya Vaidyanthan and Michael Gilmore**
(45) Registration Date: **13 April 2012**
(30) Convention priority data:
(31) Number (32) Date (33) Country
29/401513 12 Sep 2011 UNITED STATES OF AMERICA
(56) Related Art Documents: **Not Applicable**
(57) Statement of Newness and Distinctiveness: **Newness and distinctiveness reside in the pattern and/or ornamentation of a display screen with user interface as illustrated by solid lines in the accompanying representations. The features shown in broken outline are for illustrative purposes only and do not form part of the design.**

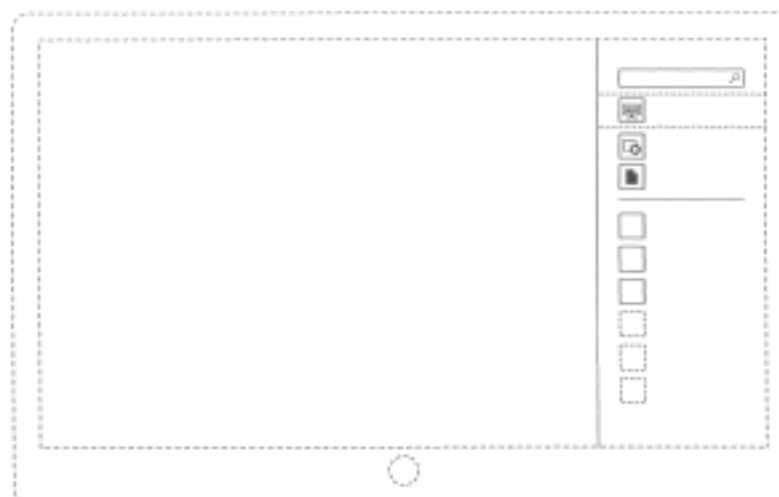

(21) Design Number: **11206/2012**
(22) Date of Filing Application: **07 March 2012**
(24) Date from which industrial property rights may have effect: **07 March 2012**
(54) Product in respect of which the design is registered: **Display screen with icon group**
(51) International Design Classification: **14-04**
(74) Name(s) of Attorney(s): **Shelston IP**
(71) Name(s) and Address(s) of Applicant(s):
Microsoft Corporation
One Microsoft Way Redmond Washington 98052 United States of America
(72) Name(s) of Designer(s): **Kieran Phelan**
(45) Registration Date: **13 April 2012**
(30) Convention priority data:
(31) Number (32) Date (33) Country
29/401548 12 Sep 2011 UNITED STATES OF AMERICA
(56) Related Art Documents: **Not Applicable**
(57) Statement of Newness and Distinctiveness: **Newness and distinctiveness reside in the pattern and/or ornamentation of a display screen with icon group as illustrated by solid lines in the accompanying representations. The features shown in broken outline are for illustrative purposes only and do not form part of the design.**

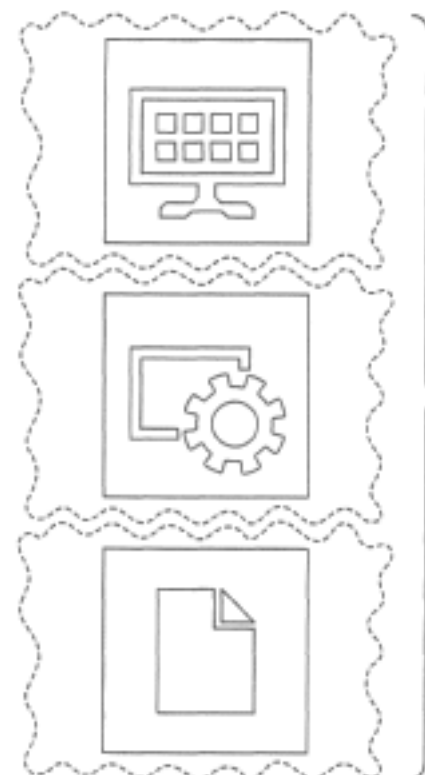

(21) Design Number: **11222/2012**
(22) Date of Filing Application: **07 March 2012**
(24) Date from which industrial property rights may have effect: **07 March 2012**
(54) Product in respect of which the design is registered: **Display screen with user interface**
(51) International Design Classification: **14-04**
(74) Name(s) of Attorney(s): **Shelston IP**
(71) Name(s) and Address(s) of Applicant(s):
Microsoft Corporation
One Microsoft Way Redmond Washington 98052 United States of America
(72) Name(s) of Designer(s): **Ethan Nelson Ray and Britt Hillary Hansing and Zach Pace and Leslie Christine MacNeal**
(45) Registration Date: **13 April 2012**
(30) Convention priority data:
(31) Number (32) Date (33) Country
29/401293 12 Sep 2011 UNITED STATES OF AMERICA
(56) Related Art Documents: **Not Applicable**
(57) Statement of Newness and Distinctiveness: **Newness and distinctiveness reside in the pattern and/or ornamentation of a display screen with user interface as illustrated by solid lines in the accompanying representations. The features shown in broken outline are for illustrative purposes only and do not form part of the design.**



- (21) Design Number: **11223/2012**
(22) Date of Filing Application: **07 March 2012**
(24) Date from which industrial property rights may have effect: **07 March 2012**
(54) Product in respect of which the design is registered: **Display screen with user interface**
(51) International Design Classification: **14-04**
(74) Name(s) of Attorney(s): **Shelston IP**
(71) Name(s) and Address(s) of Applicant(s):
Microsoft Corporation
One Microsoft Way Redmond Washington 98052 United States of America
(72) Name(s) of Designer(s): **Ben Perry and Tatjana Fournier and Leslie Christine MacNeal**
(45) Registration Date: **13 April 2012**
(30) Convention priority data:
(31) Number (32) Date (33) Country
29/401490 12 Sep 2011 UNITED STATES OF AMERICA
(56) Related Art Documents: **Not Applicable**
(57) Statement of Newness and Distinctiveness: **Newness and distinctiveness reside in the pattern and/or ornamentation of a display screen with user interface as illustrated by solid lines in the accompanying representations. The features shown in broken outline are for illustrative purposes only and do not form part of the design.**

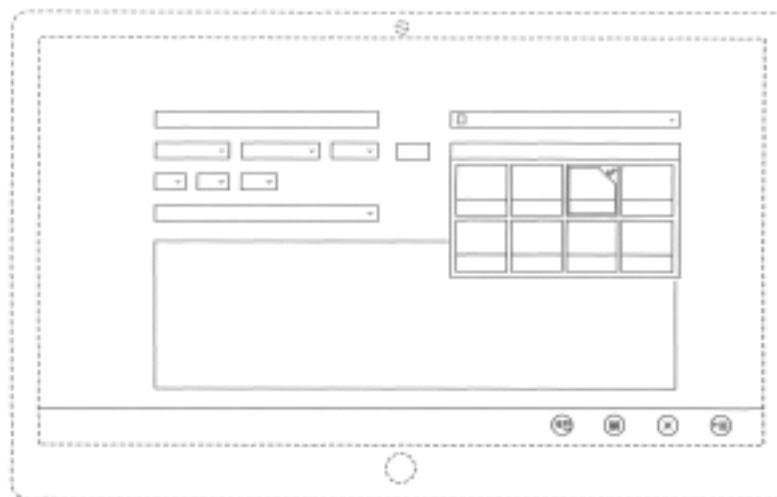

- (21) Design Number: **14643/2011**
(22) Date of Filing Application: **04 October 2011**
(24) Date from which industrial property rights may have effect: **04 October 2011**
(54) Product in respect of which the design is registered: **The designs relate to the Roll Mole Tape Finder. 8 Pages of illustrations**
(51) International Design Classification: **19-02**
(74) Name(s) of Attorney(s):
(71) Name(s) and Address(s) of Applicant(s):
Darren Fenton
21 Hampton Court Ballygowan Newtownards Down BT23 6HW Northern Ireland
Michael Little
21 Hampton Court Ballygowan Newtownards Down BT23 6HW Northern Ireland
(72) Name(s) of Designer(s): **Darren Fenton and Michael Little**
(45) Registration Date: **13 April 2012**
(30) Convention priority data:
(31) Number (32) Date (33) Country
1110150.8 16 Jun 2011 UNITED KINGDOM
(56) Related Art Documents: **Not Applicable**
(57) Statement of Newness and Distinctiveness: **The design now incorporates a metal cutter and angled tape delivery platform to take the feed of the tape away from the rest of the tape roll. The product helps easily find the end of the tape and cut to suit. Fits all diameters and types of tape.**

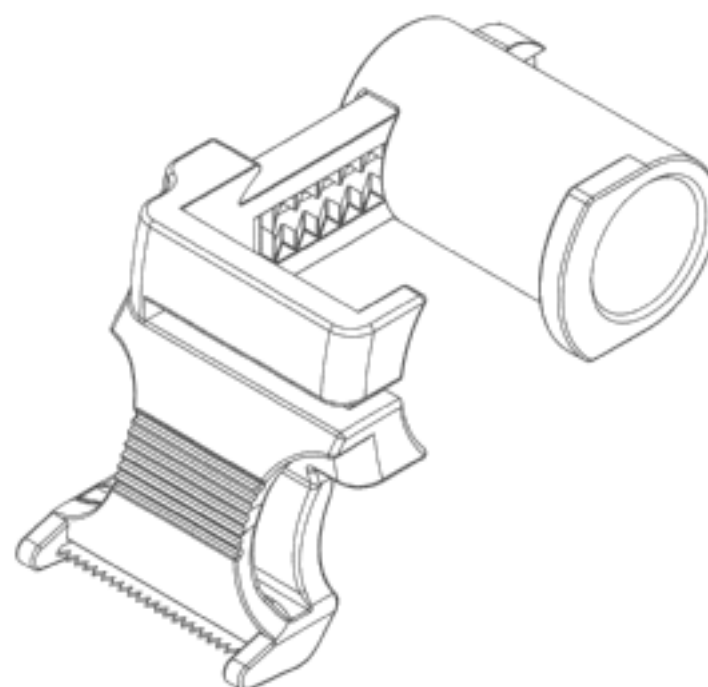

- (21) Design Number: **10151/2012**
(22) Date of Filing Application: **13 January 2012**
(24) Date from which industrial property rights may have effect: **13 January 2012**
(54) Product in respect of which the design is registered: **Ventilator**
(51) International Design Classification: **24-01**
(74) Name(s) of Attorney(s): **Halfords IP**
(71) Name(s) and Address(s) of Applicant(s):
ResMed Paris SAS
240 rue de la Motte 77550 Moissy Cramayel France
(72) Name(s) of Designer(s): **Eva Ng and Benjamin John Leavens and Kenneth Taylor and Jeremy William Workman and Frank Van Regteren and Jonathan Huw Thomas**
(45) Registration Date: **13 April 2012**
(30) Convention priority data:
(31) Number (32) Date (33) Country
29/398887 05 Aug 2011 UNITED STATES OF AMERICA
(56) Related Art Documents: **Not Applicable**
(57) Statement of Newness and Distinctiveness: **Newness and distinctiveness is claimed in those features of shape and or configuration of a ventilator as depicted in the representations.**



- (21) Design Number: **11695/2012**
(22) Date of Filing Application: **13 January 2012**
(24) Date from which industrial property rights may have effect: **13 January 2012**
(54) Product in respect of which the design is registered: **Expiratory valve**
(51) International Design Classification: **24-01**
(74) Name(s) of Attorney(s): **Halfords IP**
(71) Name(s) and Address(s) of Applicant(s):
ResMed Paris SAS
240 rue de la Motte 77550 Moissy Cramayel France
(72) Name(s) of Designer(s): **Kenneth Taylor and Benjamin John Leavens and Jonathan Huw Thomas**
(45) Registration Date: **13 April 2012**
(30) Convention priority data:
(31) Number (32) Date (33) Country
29/398887 05 Aug 2011 UNITED STATES OF AMERICA
(56) Related Art Documents: **Not Applicable**
(57) Statement of Newness and Distinctiveness: **Newness and distinctiveness is claimed in those features of shape and or configuration of a expiratory valve as depicted in the representations. The broken lines represent environment or structure and do not form a part of the claimed design. The dotted lines represent the border between claimed and unclaimed subject matter and do not form a part of the claimed design.**

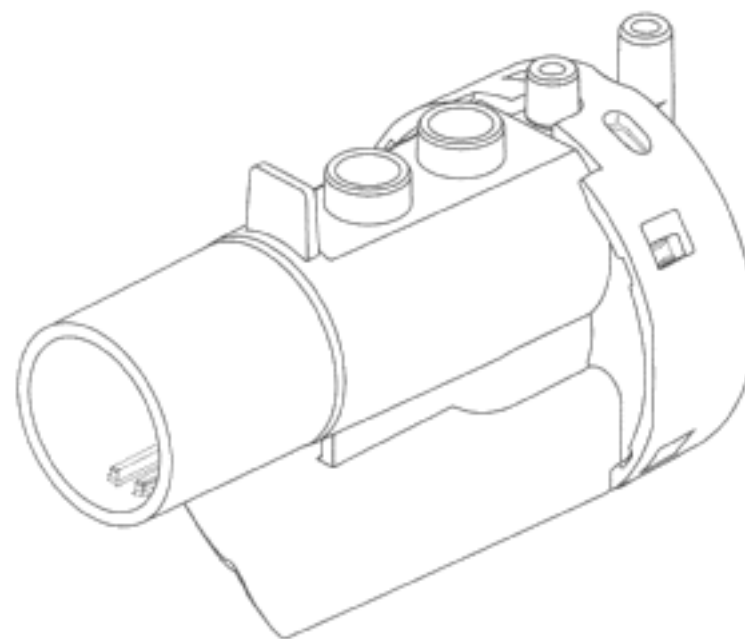

(21) Design Number: **11696/2012**
(22) Date of Filing Application: **13 January 2012**
(24) Date from which industrial property rights may have effect: **13 January 2012**
(54) Product in respect of which the design is registered: **Expiratory adaptor**
(51) International Design Classification: **24-01**
(74) Name(s) of Attorney(s): **Halfords IP**
(71) Name(s) and Address(s) of Applicant(s):
ResMed Paris SAS
240 rue de la Motte 77550 Moissy Cramayel France
(72) Name(s) of Designer(s): **Kenneth Taylor and Benjamin John Leavens**
(45) Registration Date: **13 April 2012**
(30) Convention priority data:
(31) Number (32) Date (33) Country
29/398887 05 Aug 2011 UNITED STATES OF AMERICA

(56) Related Art Documents: **Not Applicable**
(57) Statement of Newness and Distinctiveness: **Newness and distinctiveness is claimed in those features of shape and or configuration of a expiratory adaptor as depicted in the representations. The broken lines represent environment or structure and do not form a part of the claimed design. The dotted lines represent the border between claimed and unclaimed subject matter and do not form a part of the claimed design.**

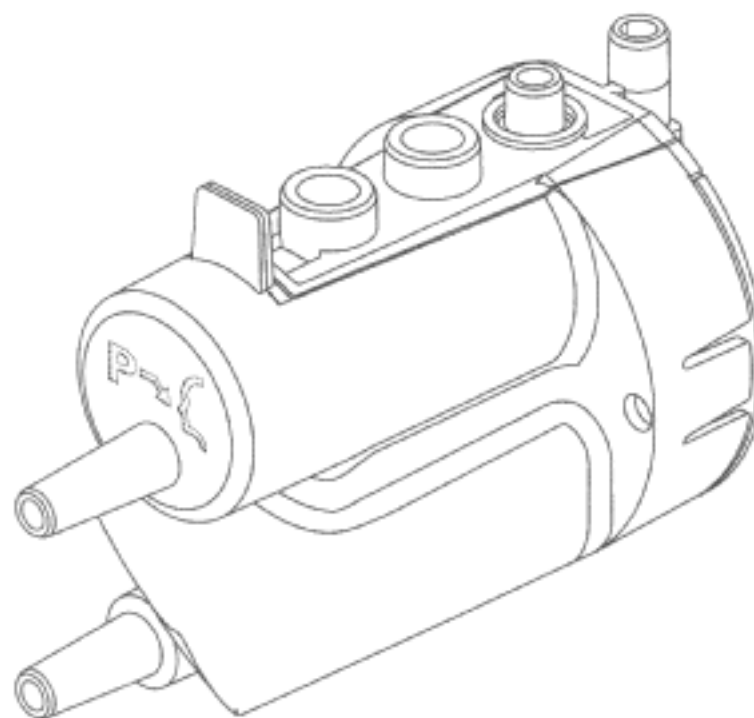

(21) Design Number: **11697/2012**
(22) Date of Filing Application: **13 January 2012**
(24) Date from which industrial property rights may have effect: **13 January 2012**
(54) Product in respect of which the design is registered: **Filter assembly**
(51) International Design Classification: **24-01**
(74) Name(s) of Attorney(s): **Halfords IP**
(71) Name(s) and Address(s) of Applicant(s):
ResMed Paris SAS
240 rue de la Motte 77550 Moissy Cramayel France
(72) Name(s) of Designer(s): **Kenneth Taylor and Eva Ng and Benjamin John Leavens and Jonathan Huw Thomas**
(45) Registration Date: **13 April 2012**
(30) Convention priority data:
(31) Number (32) Date (33) Country
29/398887 05 Aug 2011 UNITED STATES OF AMERICA

(56) Related Art Documents: **Not Applicable**
(57) Statement of Newness and Distinctiveness: **Newness and distinctiveness is claimed in those features of shape and or configuration of a filter assembly as depicted in the representations. The broken lines represent environment or structure and do not form a part of the claimed design. The dotted lines represent the border between claimed and unclaimed subject matter and do not form a part of the claimed design.**

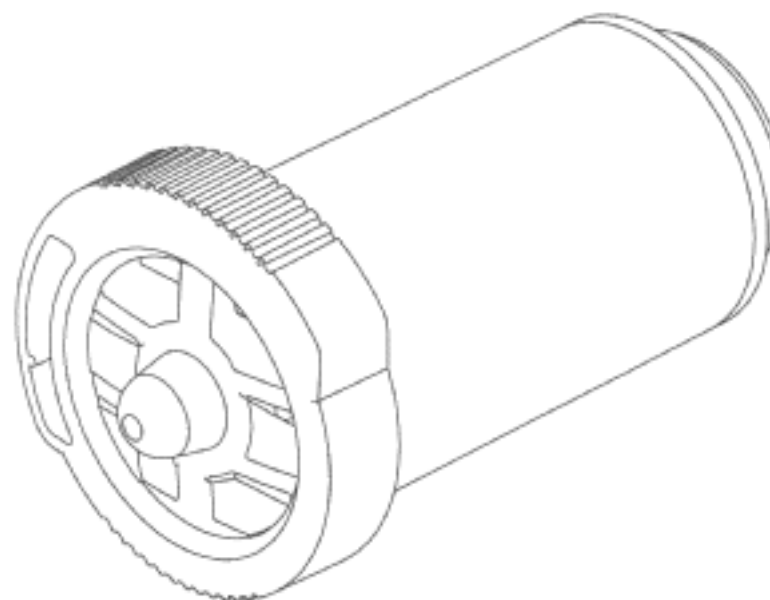

- (21) Design Number: **11698/2012**
(22) Date of Filing Application: **13 January 2012**
(24) Date from which industrial property rights may have effect: **13 January 2012**
(54) Product in respect of which the design is registered: **Filter cartridge**
(51) International Design Classification: **24-01**
(74) Name(s) of Attorney(s): **Halfords IP**
(71) Name(s) and Address(s) of Applicant(s):
ResMed Paris SAS
240 rue de la Motte 77550 Moissy Cramayel France
(72) Name(s) of Designer(s): **Kenneth Taylor and Eva Ng and Benjamin John Leavens and Jonathan Huw Thomas**
(45) Registration Date: **13 April 2012**
(30) Convention priority data:
(31) Number (32) Date (33) Country
29/398887 05 Aug 2011 UNITED STATES OF AMERICA
(56) Related Art Documents: **Not Applicable**
(57) Statement of Newness and Distinctiveness: **Newness and distinctiveness is claimed in those features of shape and or configuration of a filter cartridge as depicted in the representations.**

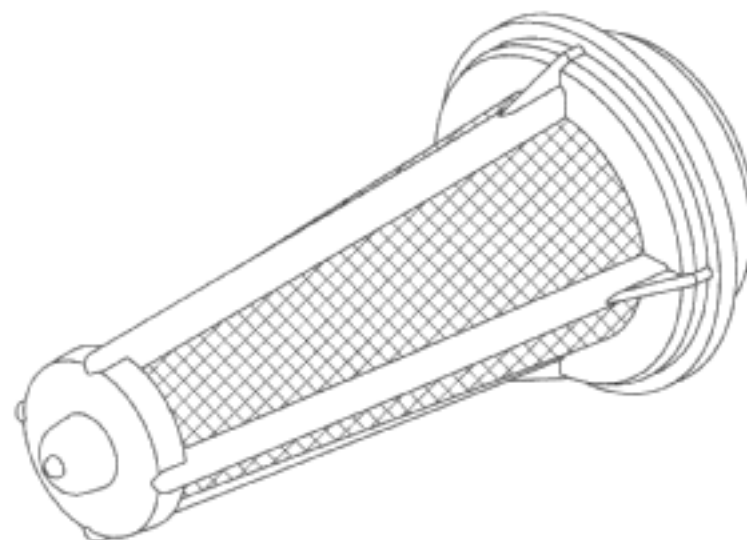

- (21) Design Number: **10559/2012**
(22) Date of Filing Application: **03 February 2012**
(24) Date from which industrial property rights may have effect: **03 February 2012**
(54) Product in respect of which the design is registered: **A jewellery display block**
(51) International Design Classification: **20-02NES**
(74) Name(s) of Attorney(s): **A J Park**
(71) Name(s) and Address(s) of Applicant(s):
Kagi IP Holding Company Limited
Level 1 30 Broadway Newmarket Auckland New Zealand
(72) Name(s) of Designer(s): **Katherine Clare Gee**
(45) Registration Date: **13 April 2012**
(30) Convention priority data:
(31) Number (32) Date (33) Country
415217 05 Aug 2011 NEW ZEALAND
(56) Related Art Documents: **Not Applicable**
(57) Statement of Newness and Distinctiveness: **The novelty claimed for the design resides in the features of shape and/or configuration of the jewellery display blocks (first and second jewellery display blocks) as shown in the representations and including the transparent front cover (switchable in orientation) and opaque base, but excluding the features shown in broken lines.**

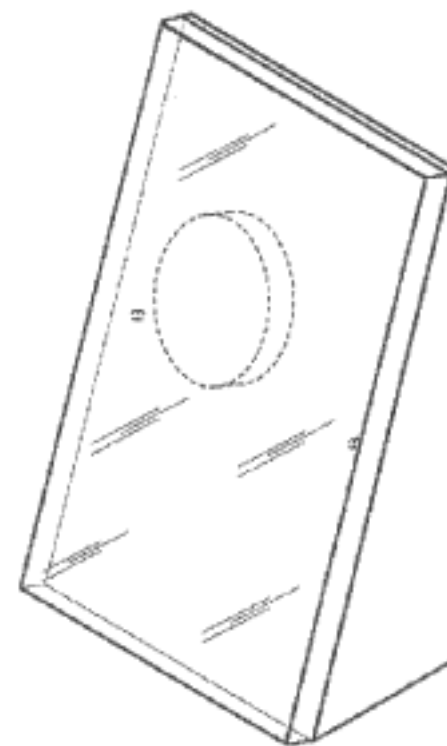

(21) Design Number: **11715/2012**
(22) Date of Filing Application: **03 February 2012**
(24) Date from which industrial property rights may have effect: **03 February 2012**
(54) Product in respect of which the design is registered: **A jewellery display block**
(51) International Design Classification: **20-02NES**
(74) Name(s) of Attorney(s): **A J Park**
(71) Name(s) and Address(s) of Applicant(s):
Kagi IP Holding Company Limited
Level 1 30 Broadway Newmarket Auckland New Zealand
(72) Name(s) of Designer(s): **Katherine Clare Gee**
(45) Registration Date: **13 April 2012**
(30) Convention priority data:
(31) Number (32) Date (33) Country
415217 05 Aug 2011 NEW ZEALAND
(56) Related Art Documents: **Not Applicable**
(57) Statement of Newness and Distinctiveness: **The novelty claimed for the design resides in the features of shape and/or configuration of the jewellery display blocks (first and second jewellery display blocks) as shown in the representations and including the transparent front cover (switchable in orientation) and opaque base, but excluding the features shown in broken lines.**

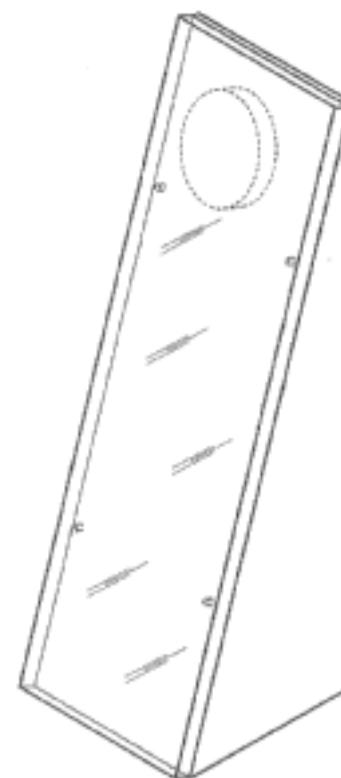

(21) Design Number: **10560/2012**
(22) Date of Filing Application: **06 February 2012**
(24) Date from which industrial property rights may have effect: **06 February 2012**
(54) Product in respect of which the design is registered: **Quilting ruler**
(51) International Design Classification: **02-07NES, 19-06**
(74) Name(s) of Attorney(s):
(71) Name(s) and Address(s) of Applicant(s):
Glen Edwin Pettiford
382 Glenrock Parade Tascott New South Wales 2250 Australia
Elizabeth Ann Wallace
382 Glenrock Parade Tascott New South Wales 2250 Australia
(72) Name(s) of Designer(s): **Glen Edwin Pettiford and Elizabeth Ann Wallace**
(45) Registration Date: **13 April 2012**
(56) Related Art Documents: **Not Applicable**
(57) Statement of Newness and Distinctiveness: **Provides multiple cutting and ruling options - including providing scant quarter inch seam allowance, drawing circles up to 24 inches in diameter and cutting 2 1/2 inch strips on a straight or bias angle.**



(21) Design Number: **11458/2012**
(22) Date of Filing Application: **21 March 2012**
(24) Date from which industrial property rights may have effect: **21 March 2012**
(54) Product in respect of which the design is registered: **Crab holding pliers**
(51) International Design Classification: **08-05P, 22-05**
(74) Name(s) of Attorney(s):
(71) Name(s) and Address(s) of Applicant(s):
Shane Doevendans
9 Ruby Grove Gunn Northern Territory 0832 Australia
(72) Name(s) of Designer(s): **Shane Doevendans**
(45) Registration Date: **13 April 2012**
(56) Related Art Documents: **Not Applicable**
(57) Statement of Newness and Distinctiveness: **Nil**

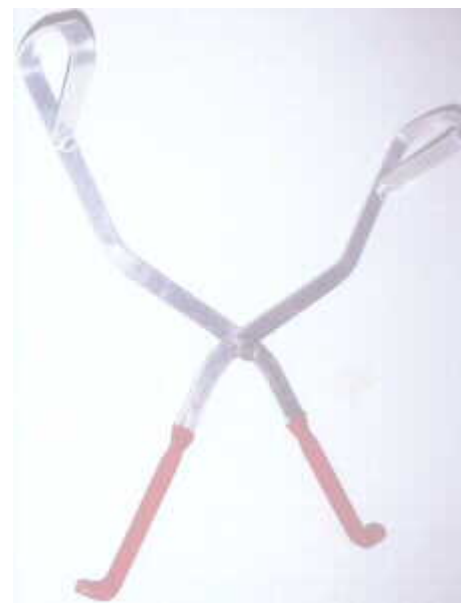

(21) Design Number: **11224/2012**
(22) Date of Filing Application: **07 March 2012**
(24) Date from which industrial property rights may have effect: **07 March 2012**
(54) Product in respect of which the design is registered: **Display screen with icon**
(51) International Design Classification: **14-04**
(74) Name(s) of Attorney(s): **Shelston IP**
(71) Name(s) and Address(s) of Applicant(s):
Microsoft Corporation
One Microsoft Way Redmond Washington 98052 United States of America
(72) Name(s) of Designer(s): **Kieran Phelan and Leslie Christine MacNeal**
(45) Registration Date: **16 April 2012**
(30) Convention priority data:
(31) Number (32) Date (33) Country
29/401538 12 Sep 2011 UNITED STATES OF AMERICA
(56) Related Art Documents: **Not Applicable**
(57) Statement of Newness and Distinctiveness: **Newness and distinctiveness reside in the pattern and/or ornamentation of a display screen with icon as illustrated by solid lines in the accompanying representations. The features shown in broken outline are for illustrative purposes only and do not form part of the design.**

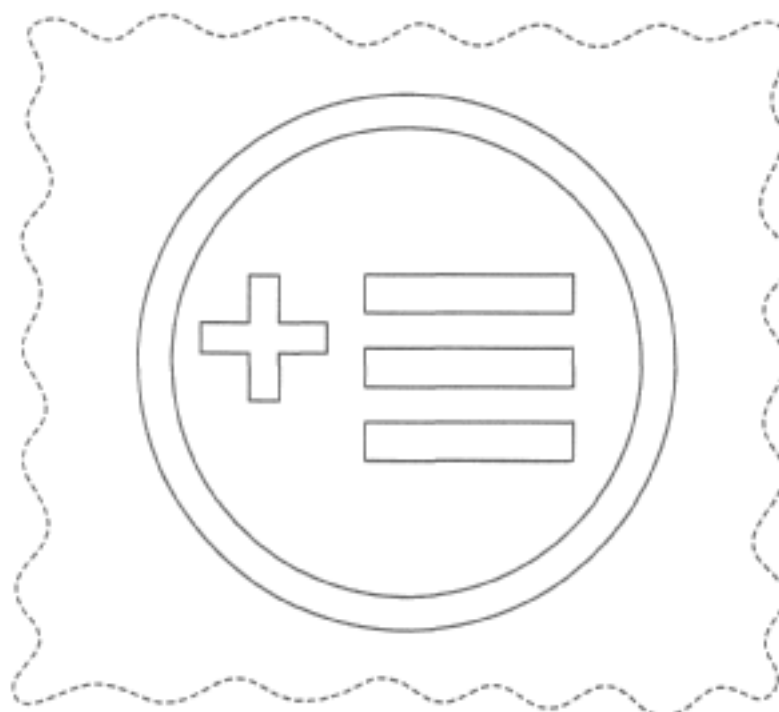

- (21) Design Number: **11225/2012**
(22) Date of Filing Application: **07 March 2012**
(24) Date from which industrial property rights may have effect: **07 March 2012**
(54) Product in respect of which the design is registered: **Display screen with user interface**
(51) International Design Classification: **14-04**
(74) Name(s) of Attorney(s): **Shelston IP**
(71) Name(s) and Address(s) of Applicant(s):
Microsoft Corporation
One Microsoft Way Redmond Washington 98052 United States of America
(72) Name(s) of Designer(s): **Hui Chun and Leslie Christine MacNeal and Orry Wijanarko Soegiono**
(45) Registration Date: **16 April 2012**
(30) Convention priority data:
(31) Number (32) Date (33) Country
29/401426 12 Sep 2011 UNITED STATES OF AMERICA
(56) Related Art Documents: **Not Applicable**
(57) Statement of Newness and Distinctiveness: **Newness and distinctiveness reside in the pattern and/or ornamentation of a display screen with user interface as illustrated by solid lines in the accompanying representations. The features shown in broken outline are for illustrative purposes only and do not form part of the design.**

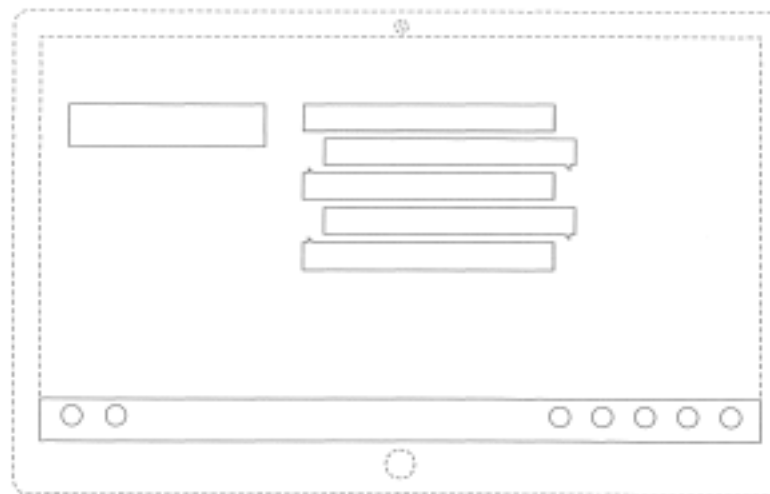

- (21) Design Number: **11226/2012**
(22) Date of Filing Application: **07 March 2012**
(24) Date from which industrial property rights may have effect: **07 March 2012**
(54) Product in respect of which the design is registered: **Display screen with icon set**
(51) International Design Classification: **14-04**
(74) Name(s) of Attorney(s): **Shelston IP**
(71) Name(s) and Address(s) of Applicant(s):
Microsoft Corporation
One Microsoft Way Redmond Washington 98052 United States of America
(72) Name(s) of Designer(s): **Michael H. LaManna and Travis Eby and Jessica Murray and Kieran Phelan and Catherine White**
(45) Registration Date: **16 April 2012**
(30) Convention priority data:
(31) Number (32) Date (33) Country
29/401432 12 Sep 2011 UNITED STATES OF AMERICA
(56) Related Art Documents: **Not Applicable**
(57) Statement of Newness and Distinctiveness: **Newness and distinctiveness reside in the pattern and/or ornamentation of a display screen with icon set as illustrated by solid lines in the accompanying representations. The features shown in broken outline are for illustrative purposes only and do not form part of the design.**

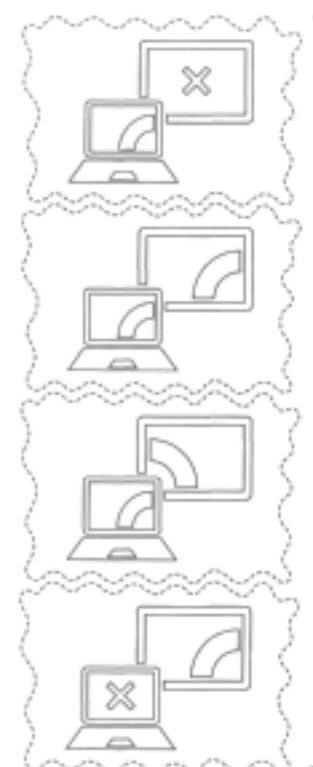

- (21) Design Number: **11227/2012**
(22) Date of Filing Application: **07 March 2012**
(24) Date from which industrial property rights may have effect: **07 March 2012**
(54) Product in respect of which the design is registered: **Display screen with user interface**
(51) International Design Classification: **14-04**
(74) Name(s) of Attorney(s): **Shelston IP**
(71) Name(s) and Address(s) of Applicant(s):
Microsoft Corporation
One Microsoft Way Redmond Washington 98052 United States of America
(72) Name(s) of Designer(s): **Patrick Wujcik and Marc Pottier and Michael H. LaManna and Khurram Zia and Jeffrey Weir**
(45) Registration Date: **16 April 2012**
(30) Convention priority data:
(31) Number (32) Date (33) Country
29/401466 12 Sep 2011 UNITED STATES OF AMERICA
(56) Related Art Documents: **Not Applicable**
(57) Statement of Newness and Distinctiveness: **Newness and distinctiveness reside in the pattern and/or ornamentation of a display screen with user interface as illustrated by solid lines in the accompanying representations. The features shown in broken outline are for illustrative purposes only and do not form part of the design.**

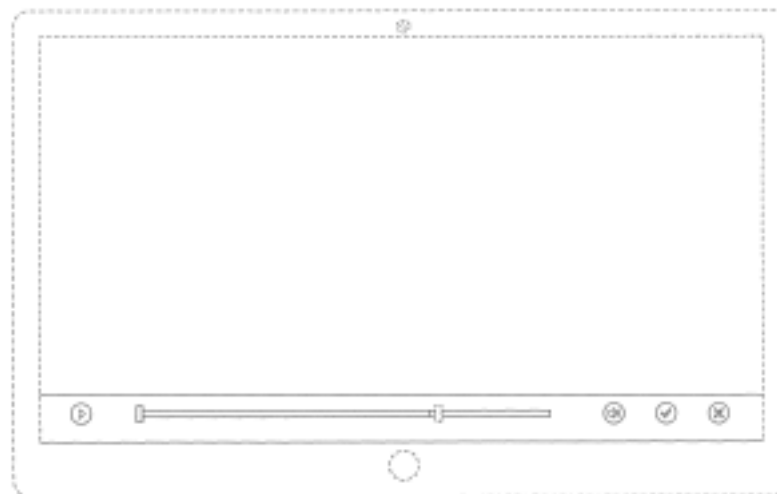

- (21) Design Number: **11228/2012**
(22) Date of Filing Application: **07 March 2012**
(24) Date from which industrial property rights may have effect: **07 March 2012**
(54) Product in respect of which the design is registered: **Display screen with user interface**
(51) International Design Classification: **14-04**
(74) Name(s) of Attorney(s): **Shelston IP**
(71) Name(s) and Address(s) of Applicant(s):
Microsoft Corporation
One Microsoft Way Redmond Washington 98052 United States of America
(72) Name(s) of Designer(s): **Patrick Wujcik and Marc Pottier and Michael H. LaManna and Khurram Zia**
(45) Registration Date: **16 April 2012**
(30) Convention priority data:
(31) Number (32) Date (33) Country
29/401464 12 Sep 2011 UNITED STATES OF AMERICA
(56) Related Art Documents: **Not Applicable**
(57) Statement of Newness and Distinctiveness: **Newness and distinctiveness reside in the pattern and/or ornamentation of a display screen with user interface as illustrated by solid lines in the accompanying representations. The features shown in broken outline are for illustrative purposes only and do not form part of the design.**

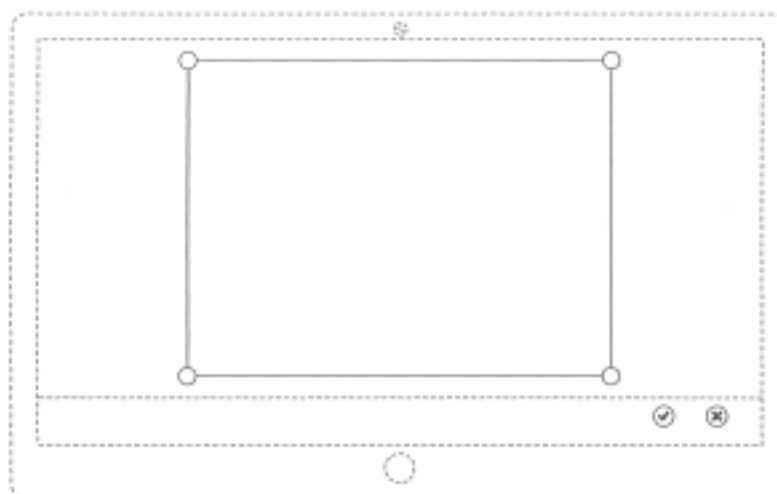

(21) Design Number: **11229/2012**
(22) Date of Filing Application: **07 March 2012**
(24) Date from which industrial property rights may have effect: **07 March 2012**
(54) Product in respect of which the design is registered: **Display screen with user interface**
(51) International Design Classification: **14-04**
(74) Name(s) of Attorney(s): **Shelston IP**
(71) Name(s) and Address(s) of Applicant(s):
Microsoft Corporation
One Microsoft Way Redmond Washington 98052 United States of America
(72) Name(s) of Designer(s): **Jason P. Kriese and J. Craig Hally**
(45) Registration Date: **16 April 2012**
(30) Convention priority data:
(31) Number (32) Date (33) Country
29/401484 12 Sep 2011 UNITED STATES OF AMERICA
(56) Related Art Documents: **Not Applicable**
(57) Statement of Newness and Distinctiveness: **Newness and distinctiveness reside in the pattern and/or ornamentation of a display screen with user interface as illustrated by solid lines in the accompanying representations. The features shown in broken outline are for illustrative purposes only and do not form part of the design.**

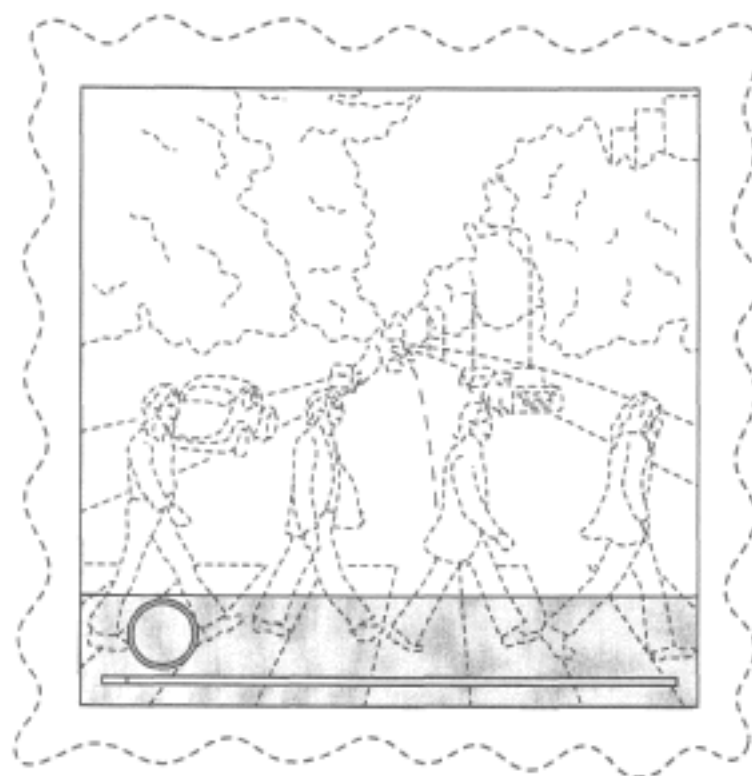

(21) Design Number: **11230/2012**
(22) Date of Filing Application: **07 March 2012**
(24) Date from which industrial property rights may have effect: **07 March 2012**
(54) Product in respect of which the design is registered: **Display screen with user interface**
(51) International Design Classification: **14-04**
(74) Name(s) of Attorney(s): **Shelston IP**
(71) Name(s) and Address(s) of Applicant(s):
Microsoft Corporation
One Microsoft Way Redmond Washington 98052 United States of America
(72) Name(s) of Designer(s): **Jason P. Kriese and J. Craig Hally**
(45) Registration Date: **16 April 2012**
(30) Convention priority data:
(31) Number (32) Date (33) Country
29/401523 12 Sep 2011 UNITED STATES OF AMERICA
(56) Related Art Documents: **Not Applicable**
(57) Statement of Newness and Distinctiveness: **Newness and distinctiveness reside in the pattern and/or ornamentation of a display screen with user interface as illustrated by solid lines in the accompanying representations. The features shown in broken outline are for illustrative purposes only and do not form part of the design.**



- (21) Design Number: **11231/2012**
(22) Date of Filing Application: **07 March 2012**
(24) Date from which industrial property rights may have effect: **07 March 2012**
(54) Product in respect of which the design is registered: **Display screen with user interface**
(51) International Design Classification: **14-04**
(74) Name(s) of Attorney(s): **Shelston IP**
(71) Name(s) and Address(s) of Applicant(s):
Microsoft Corporation
One Microsoft Way Redmond Washington 98052 United States of America
(72) Name(s) of Designer(s): **Michael H. LaManna and Kieran Phelan and Patrick Wujcik and Ken Hardy and Priya Danawate**
(45) Registration Date: **16 April 2012**
(30) Convention priority data:
(31) Number (32) Date (33) Country
29/401470 12 Sep 2011 UNITED STATES OF AMERICA
(56) Related Art Documents: **Not Applicable**
(57) Statement of Newness and Distinctiveness: **Newness and distinctiveness reside in the pattern and/or ornamentation of a display screen with user interface as illustrated by solid lines in the accompanying representations. The features shown in broken outline are for illustrative purposes only and do not form part of the design.**

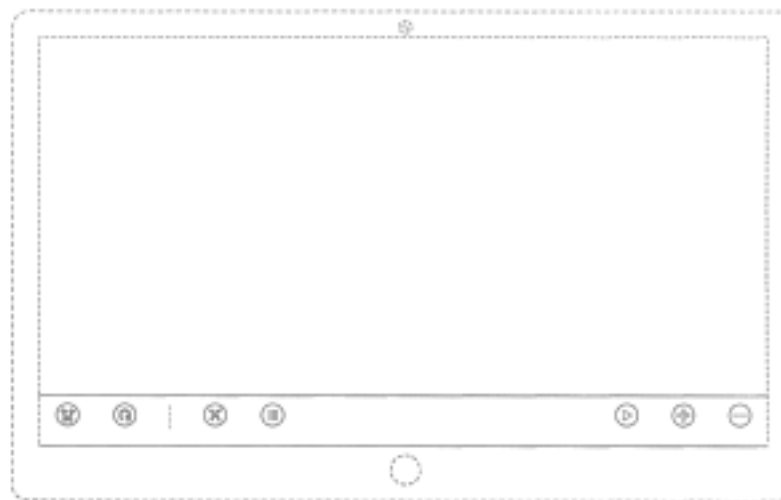

- (21) Design Number: **11232/2012**
(22) Date of Filing Application: **07 March 2012**
(24) Date from which industrial property rights may have effect: **07 March 2012**
(54) Product in respect of which the design is registered: **Display screen with icon**
(51) International Design Classification: **14-04**
(74) Name(s) of Attorney(s): **Shelston IP**
(71) Name(s) and Address(s) of Applicant(s):
Microsoft Corporation
One Microsoft Way Redmond Washington 98052 United States of America
(72) Name(s) of Designer(s): **Michael H. LaManna and Travis Eby and Jessica Murray and Kieran Phelan and Catherine White**
(45) Registration Date: **16 April 2012**
(30) Convention priority data:
(31) Number (32) Date (33) Country
29/401431 12 Sep 2011 UNITED STATES OF AMERICA
(56) Related Art Documents: **Not Applicable**
(57) Statement of Newness and Distinctiveness: **Newness and distinctiveness reside in the pattern and/or ornamentation of a display screen with icon as illustrated by solid lines in the accompanying representations. The features shown in broken outline are for illustrative purposes only and do not form part of the design.**



(21) Design Number: **11234/2012**
(22) Date of Filing Application: **07 March 2012**
(24) Date from which industrial property rights may have effect: **07 March 2012**
(54) Product in respect of which the design is registered: **Display screen with icon set**
(51) International Design Classification: **14-04**
(74) Name(s) of Attorney(s): **Shelston IP**
(71) Name(s) and Address(s) of Applicant(s):
Microsoft Corporation
One Microsoft Way Redmond Washington 98052 United States of America
(72) Name(s) of Designer(s): **Kieran Phelan**
(45) Registration Date: **16 April 2012**
(30) Convention priority data:
(31) Number (32) Date (33) Country
29/401533 12 Sep 2011 UNITED STATES OF AMERICA
(56) Related Art Documents: **Not Applicable**
(57) Statement of Newness and Distinctiveness: **Newness and distinctiveness reside in the pattern and/or ornamentation of a display screen with icon set as illustrated by solid lines in the accompanying representations. The features shown in broken outline are for illustrative purposes only and do not form part of the design.**

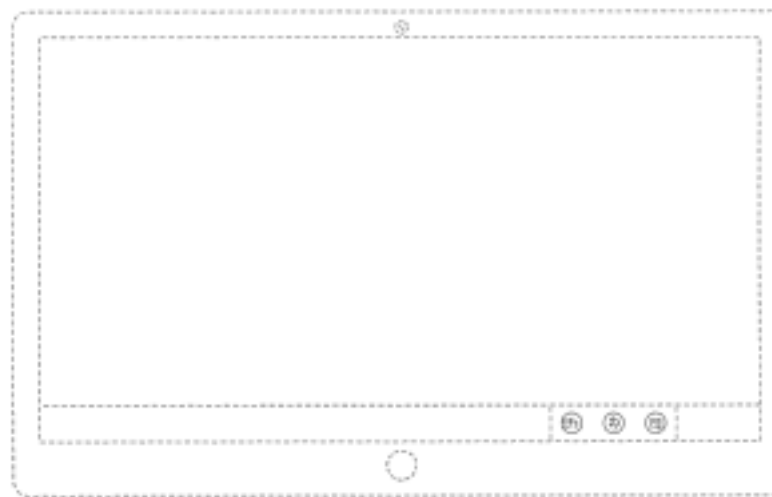

(21) Design Number: **11235/2012**
(22) Date of Filing Application: **07 March 2012**
(24) Date from which industrial property rights may have effect: **07 March 2012**
(54) Product in respect of which the design is registered: **Display screen with user interface**
(51) International Design Classification: **14-04**
(74) Name(s) of Attorney(s): **Shelston IP**
(71) Name(s) and Address(s) of Applicant(s):
Microsoft Corporation
One Microsoft Way Redmond Washington 98052 United States of America
(72) Name(s) of Designer(s): **Lisa Carolyn Cherian and Alton Kwok and Gerrit Hofmeester and Orry Wijanarko Soegiono**
(45) Registration Date: **16 April 2012**
(30) Convention priority data:
(31) Number (32) Date (33) Country
29/401463 12 Sep 2011 UNITED STATES OF AMERICA
(56) Related Art Documents: **Not Applicable**
(57) Statement of Newness and Distinctiveness: **Newness and distinctiveness reside in the pattern and/or ornamentation of a display screen with user interface as illustrated by solid lines in the accompanying representations. The features shown in broken outline are for illustrative purposes only and do not form part of the design.**

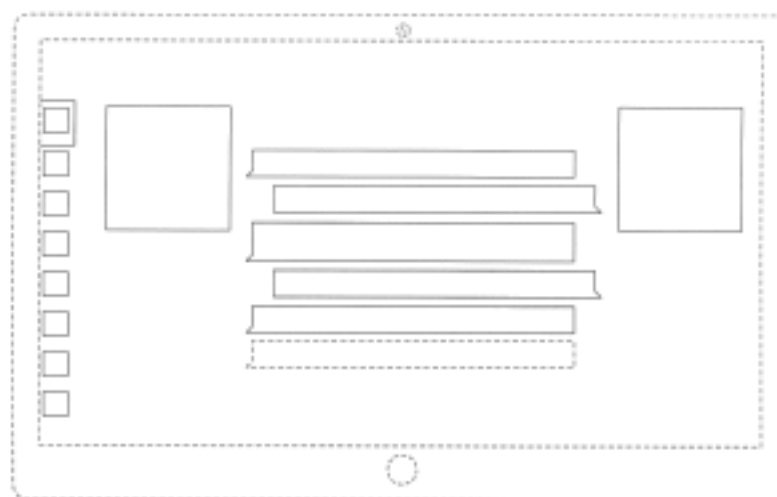

- (21) Design Number: **11236/2012**
(22) Date of Filing Application: **07 March 2012**
(24) Date from which industrial property rights may have effect: **07 March 2012**
(54) Product in respect of which the design is registered: **Display screen with user interface**
(51) International Design Classification: **14-04**
(74) Name(s) of Attorney(s): **Shelston IP**
(71) Name(s) and Address(s) of Applicant(s):
Microsoft Corporation
One Microsoft Way Redmond Washington 98052 United States of America
(72) Name(s) of Designer(s): **Orry Wijanarko Soegiono and Alton Kwok and Hui Chun Ku**
(45) Registration Date: **16 April 2012**
(30) Convention priority data:
(31) Number (32) Date (33) Country
29/401456 12 Sep 2011 UNITED STATES OF AMERICA
(56) Related Art Documents: **Not Applicable**
(57) Statement of Newness and Distinctiveness: **Newness and distinctiveness reside in the pattern and/or ornamentation of a display screen with user interface as illustrated by solid lines in the accompanying representations. The features shown in broken outline are for illustrative purposes only and do not form part of the design.**

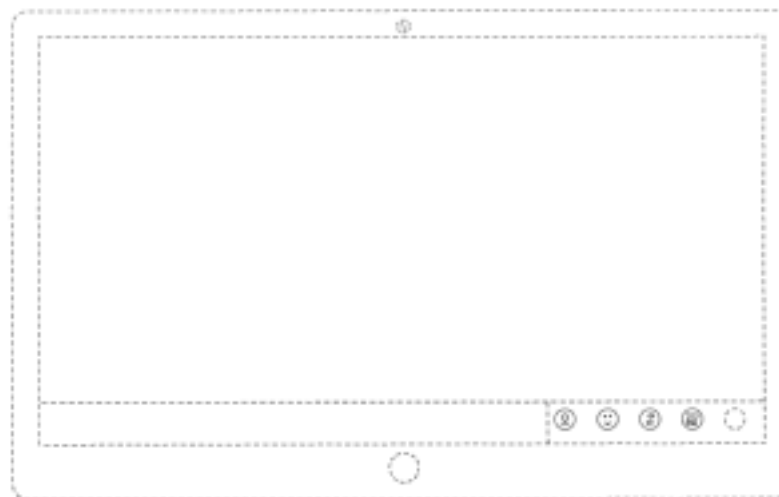

- (21) Design Number: **11049/2012**
(22) Date of Filing Application: **05 March 2012**
(24) Date from which industrial property rights may have effect: **05 March 2012**
(54) Product in respect of which the design is registered: **Swimwear garment**
(51) International Design Classification: **02-02A**
(74) Name(s) of Attorney(s):
(71) Name(s) and Address(s) of Applicant(s):
JETS Swimwear Pty Limited
8-18 Bowden Street Alexandria New South Wales 2015 Australia
(72) Name(s) of Designer(s): **Jessika Allen**
(45) Registration Date: **16 April 2012**
(56) Related Art Documents: **Not Applicable**
(57) Statement of Newness and Distinctiveness: **Newness and distinctiveness is claimed in the shape, configuration, pattern and/or ornamentation of the swimwear garment as depicted in the accompanying representations. In considering the newness and distinctiveness of the design, the outline of the wearer shown in broken lines forms no part of the design.**

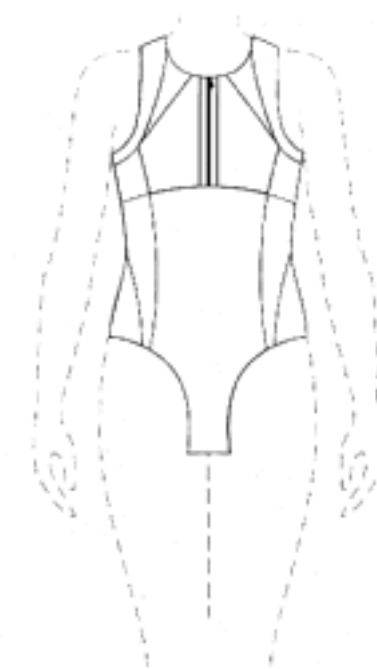

- (21) Design Number: **11050/2012**
(22) Date of Filing Application: **05 March 2012**
(24) Date from which industrial property rights may have effect: **05 March 2012**
(54) Product in respect of which the design is registered: **Swimwear garment**
(51) International Design Classification: **02-02A**
(74) Name(s) of Attorney(s):
(71) Name(s) and Address(s) of Applicant(s):
JETS Swimwear Pty Limited
8-18 Bowden Street Alexandria New South Wales 2015 Australia
(72) Name(s) of Designer(s): **Jessika Allen**
(45) Registration Date: **16 April 2012**
(56) Related Art Documents: **Not Applicable**
(57) Statement of Newness and Distinctiveness: **Newness and distinctiveness is claimed in the shape, configuration, pattern and/or ornamentation of the swimwear garment as depicted in the accompanying representations. In considering the newness and distinctiveness of the design, the outline of the wearer shown in broken lines forms no part of the design.**

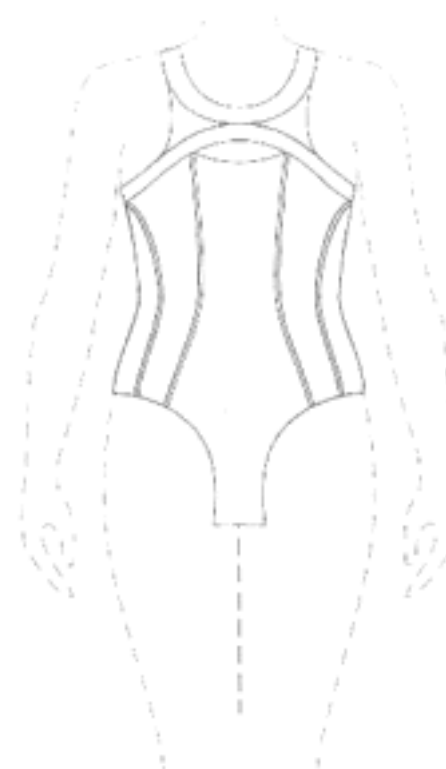

- (21) Design Number: **11051/2012**
(22) Date of Filing Application: **05 March 2012**
(24) Date from which industrial property rights may have effect: **05 March 2012**
(54) Product in respect of which the design is registered: **Swimwear garment**
(51) International Design Classification: **02-02A**
(74) Name(s) of Attorney(s):
(71) Name(s) and Address(s) of Applicant(s):
JETS Swimwear Pty Limited
8-18 Bowden Street Alexandria New South Wales 2015 Australia
(72) Name(s) of Designer(s): **Jessika Allen**
(45) Registration Date: **16 April 2012**
(56) Related Art Documents: **Not Applicable**
(57) Statement of Newness and Distinctiveness: **Newness and distinctiveness is claimed in the shape, configuration, pattern and/or ornamentation of the swimwear garment as depicted in the accompanying representations. In considering the newness and distinctiveness of the design, the outline of the wearer shown in broken lines forms no part of the design.**

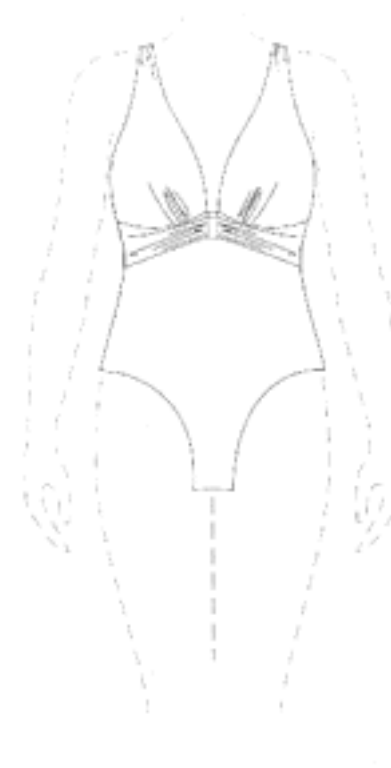

- (21) Design Number: **11052/2012**
(22) Date of Filing Application: **05 March 2012**
(24) Date from which industrial property rights may have effect: **05 March 2012**
(54) Product in respect of which the design is registered: **Swimwear garment**
(51) International Design Classification: **02-02A**
(74) Name(s) of Attorney(s):
(71) Name(s) and Address(s) of Applicant(s):
JETS Swimwear Pty Limited
8-18 Bowden Street Alexandria New South Wales 2015 Australia
(72) Name(s) of Designer(s): **Jessika Allen**
(45) Registration Date: **16 April 2012**
(56) Related Art Documents: **Not Applicable**
(57) Statement of Newness and Distinctiveness: **Newness and distinctiveness is claimed in the shape, configuration, pattern and/or ornamentation of the swimwear garment as depicted in the accompanying representations. In considering the newness and distinctiveness of the design, the lines shown in the central panel in the front view, as indicated "A", are to be disregarded. The back straps and the outline of the wearer, all shown in broken lines, form no part of the design.**

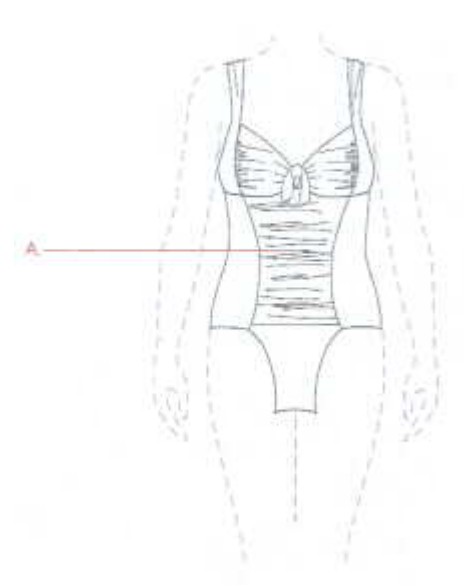

- (21) Design Number: **11053/2012**
(22) Date of Filing Application: **05 March 2012**
(24) Date from which industrial property rights may have effect: **05 March 2012**
(54) Product in respect of which the design is registered: **Swimwear garment**
(51) International Design Classification: **02-02A**
(74) Name(s) of Attorney(s):
(71) Name(s) and Address(s) of Applicant(s):
JETS Swimwear Pty Limited
8-18 Bowden Street Alexandria New South Wales 2015 Australia
(72) Name(s) of Designer(s): **Jessika Allen**
(45) Registration Date: **16 April 2012**
(56) Related Art Documents: **Not Applicable**
(57) Statement of Newness and Distinctiveness: **Newness and distinctiveness is claimed in the shape, configuration, pattern and/or ornamentation of the swimwear garment as depicted in the accompanying representations. In considering the newness and distinctiveness of the design, the outline of the wearer shown in broken lines forms no part of the design.**



- (21) Design Number: **11054/2012**
(22) Date of Filing Application: **05 March 2012**
(24) Date from which industrial property rights may have effect: **05 March 2012**
(54) Product in respect of which the design is registered: **Swimwear garment**
(51) International Design Classification: **02-02A**
(74) Name(s) of Attorney(s):
(71) Name(s) and Address(s) of Applicant(s):
JETS Swimwear Pty Limited
8-18 Bowden Street Alexandria New South Wales 2015 Australia
(72) Name(s) of Designer(s): **Jessika Allen**
(45) Registration Date: **16 April 2012**
(56) Related Art Documents: **Not Applicable**
(57) Statement of Newness and Distinctiveness: **Newness and distinctiveness is claimed in the shape, configuration, pattern and/or ornamentation of the swimwear garment as depicted in the accompanying representations. In considering the newness and distinctiveness of the design, the front and back straps, the tie and the outline of the wearer, all shown in broken lines, form no part of the design.**

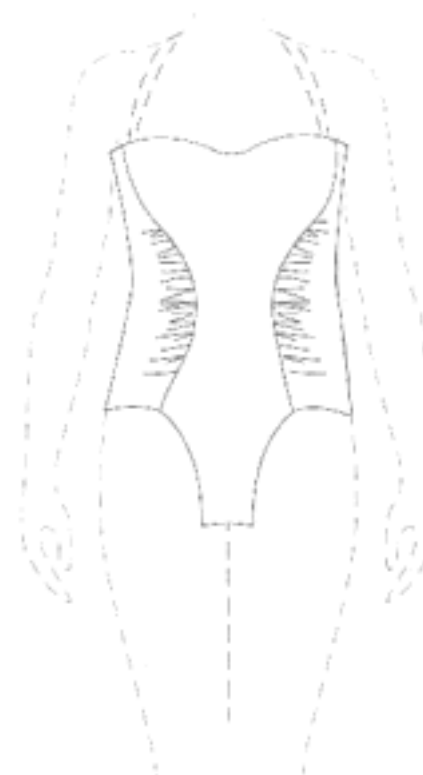

- (21) Design Number: **11055/2012**
(22) Date of Filing Application: **05 March 2012**
(24) Date from which industrial property rights may have effect: **05 March 2012**
(54) Product in respect of which the design is registered: **Swimwear garment**
(51) International Design Classification: **02-02A**
(74) Name(s) of Attorney(s):
(71) Name(s) and Address(s) of Applicant(s):
JETS Swimwear Pty Limited
8-18 Bowden Street Alexandria New South Wales 2015 Australia
(72) Name(s) of Designer(s): **Jessika Allen**
(45) Registration Date: **16 April 2012**
(56) Related Art Documents: **Not Applicable**
(57) Statement of Newness and Distinctiveness: **Newness and distinctiveness is claimed in the shape, configuration, pattern and/or ornamentation of the swimwear garment as depicted in the accompanying representations. In considering the newness and distinctiveness of the design, the back neck strap, both ties in the back view, and the outline of the wearer, all shown in broken lines, form no part of the design.**



- (21) Design Number: **11056/2012**
(22) Date of Filing Application: **05 March 2012**
(24) Date from which industrial property rights may have effect: **05 March 2012**
(54) Product in respect of which the design is registered: **Swimwear garment**
(51) International Design Classification: **02-02A**
(74) Name(s) of Attorney(s):
(71) Name(s) and Address(s) of Applicant(s):
JETS Swimwear Pty Limited
8-18 Bowden Street Alexandria New South Wales 2015 Australia
(72) Name(s) of Designer(s): **Jessika Allen**
(45) Registration Date: **16 April 2012**
(56) Related Art Documents: **Not Applicable**
(57) Statement of Newness and Distinctiveness: **Newness and distinctiveness is claimed in the shape, configuration, pattern and/or ornamentation of the swimwear garment as depicted in the accompanying representations. In considering the newness and distinctiveness of the design, the back neck strap, both ties in the back view, and the outline of the wearer, all shown in broken lines, form no part of the design.**



- (21) Design Number: **11057/2012**
(22) Date of Filing Application: **05 March 2012**
(24) Date from which industrial property rights may have effect: **05 March 2012**
(54) Product in respect of which the design is registered: **Swimwear garment**
(51) International Design Classification: **02-02A**
(74) Name(s) of Attorney(s):
(71) Name(s) and Address(s) of Applicant(s):
JETS Swimwear Pty Limited
8-18 Bowden Street Alexandria New South Wales 2015 Australia
(72) Name(s) of Designer(s): **Jessika Allen**
(45) Registration Date: **16 April 2012**
(56) Related Art Documents: **Not Applicable**
(57) Statement of Newness and Distinctiveness: **Newness and distinctiveness is claimed in the shape, configuration, pattern and/or ornamentation of the swimwear garment as depicted in the accompanying representations. In considering the newness and distinctiveness of the design, the back neck strap, both ties in the back view, and the outline of the wearer, all shown in broken lines, form no part of the design.**

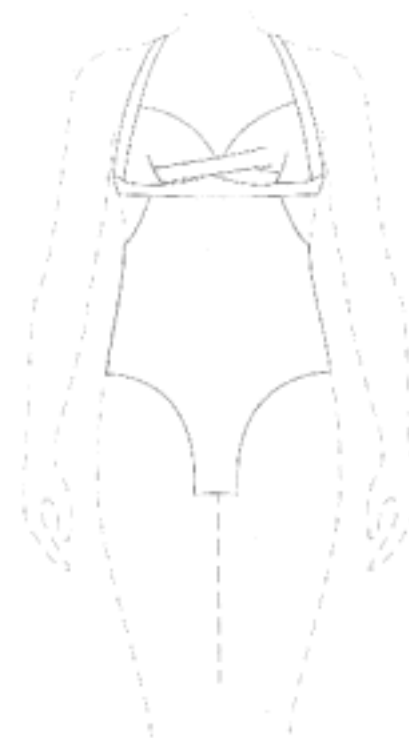

- (21) Design Number: **11058/2012**
(22) Date of Filing Application: **05 March 2012**
(24) Date from which industrial property rights may have effect: **05 March 2012**
(54) Product in respect of which the design is registered: **Swimwear garment**
(51) International Design Classification: **02-02A**
(74) Name(s) of Attorney(s):
(71) Name(s) and Address(s) of Applicant(s):
JETS Swimwear Pty Limited
8-18 Bowden Street Alexandria New South Wales 2015 Australia
(72) Name(s) of Designer(s): **Jessika Allen**
(45) Registration Date: **16 April 2012**
(56) Related Art Documents: **Not Applicable**
(57) Statement of Newness and Distinctiveness: **Newness and distinctiveness is claimed in the shape, configuration, pattern and/or ornamentation of the swimwear garment as depicted in the accompanying representations. In considering the newness and distinctiveness of the design, the clasp shown in the back view, as indicated at "A" is to be disregarded. The front and back straps, the tie in the back view, and the outline of the wearer, all shown in broken lines, forms no part of the design.**

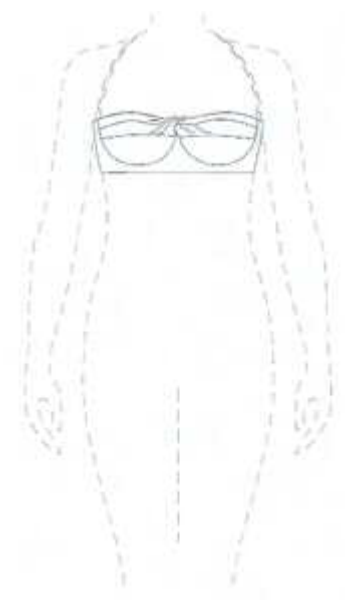

- (21) Design Number: **11059/2012**
(22) Date of Filing Application: **05 March 2012**
(24) Date from which industrial property rights may have effect: **05 March 2012**
(54) Product in respect of which the design is registered: **Swimwear garment**
(51) International Design Classification: **02-02A**
(74) Name(s) of Attorney(s):
(71) Name(s) and Address(s) of Applicant(s):
JETS Swimwear Pty Limited
8-18 Bowden Street Alexandria New South Wales 2015 Australia
(72) Name(s) of Designer(s): **Jessika Allen**
(45) Registration Date: **16 April 2012**
(56) Related Art Documents: **Not Applicable**
(57) Statement of Newness and Distinctiveness: **Newness and distinctiveness is claimed in the shape, configuration, pattern and/or ornamentation of the swimwear garment as depicted in the accompanying representations. In considering the newness and distinctiveness of the design, the line under the bust shown in the front view, as indicated at "A", is to be disregarded on both the left and the right side of the front view of the garment. The back neck strap, the tie in the back view, and the outline of the wearer, all shown in broken lines, form no part of the design.**

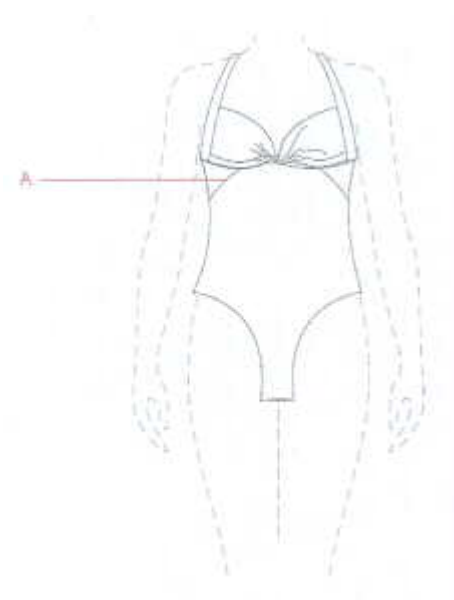

- (21) Design Number: **11060/2012**
(22) Date of Filing Application: **05 March 2012**
(24) Date from which industrial property rights may have effect: **05 March 2012**
(54) Product in respect of which the design is registered: **Swimwear garment**
(51) International Design Classification: **02-02A**
(74) Name(s) of Attorney(s):
(71) Name(s) and Address(s) of Applicant(s):

JETS Swimwear Pty Limited
8-18 Bowden Street Alexandria New South Wales 2015 Australia

(72) Name(s) of Designer(s): **Jessika Allen**

(45) Registration Date: **16 April 2012**

(56) Related Art Documents: **Not Applicable**

(57) Statement of Newness and Distinctiveness: **Newness and distinctiveness is claimed in the shape, configuration, pattern and/or ornamentation of the swimwear garment as depicted in the accompanying representations. In considering the newness and distinctiveness of the design, the lines shown in the front and the back view, as indicated at "A", are to be disregarded. The front and back straps, the tie in the back view, and the outline of the wearer, all shown in broken lines, form no part of the design.**

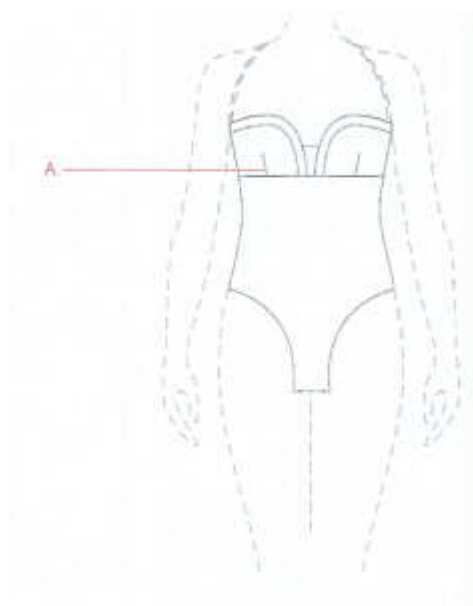

- (21) Design Number: **11061/2012**
(22) Date of Filing Application: **05 March 2012**
(24) Date from which industrial property rights may have effect: **05 March 2012**
(54) Product in respect of which the design is registered: **Swimwear garment**
(51) International Design Classification: **02-02A**
(74) Name(s) of Attorney(s):
(71) Name(s) and Address(s) of Applicant(s):

JETS Swimwear Pty Limited
8-18 Bowden Street Alexandria New South Wales 2015 Australia

(72) Name(s) of Designer(s): **Jessika Allen**

(45) Registration Date: **16 April 2012**

(56) Related Art Documents: **Not Applicable**

(57) Statement of Newness and Distinctiveness: **Newness and distinctiveness is claimed in the shape, configuration, pattern and/or ornamentation of the swimwear garment as depicted in the accompanying representations. In considering the newness and distinctiveness of the design, the seam at the bust shown in the front view, as indicated at "A" and the clasp shown in the back view, as indicated at "A" are to be disregarded. The front and back straps, the tie in the back view, and the outline of the wearer, all shown in broken lines, form no part of the design.**

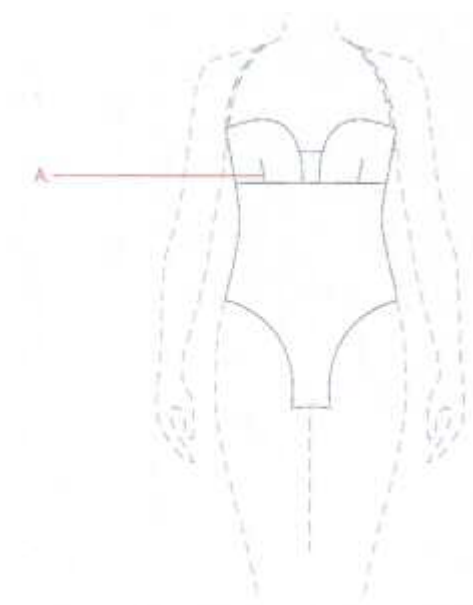

- (21) Design Number: **11062/2012**
(22) Date of Filing Application: **05 March 2012**
(24) Date from which industrial property rights may have effect: **05 March 2012**
(54) Product in respect of which the design is registered: **Swimwear garment**
(51) International Design Classification: **02-02A**
(74) Name(s) of Attorney(s):
(71) Name(s) and Address(s) of Applicant(s):
JETS Swimwear Pty Limited
8-18 Bowden Street Alexandria New South Wales 2015 Australia
(72) Name(s) of Designer(s): **Jessika Allen**
(45) Registration Date: **16 April 2012**
(56) Related Art Documents: **Not Applicable**
(57) Statement of Newness and Distinctiveness: **Newness and distinctiveness is claimed in the shape, configuration, pattern and/or ornamentation of the swimwear garment as depicted in the accompanying representations. In considering the newness and distinctiveness of the design, the clasp shown in the back view, as indicated at "A", is to be disregarded. The front and back straps, and the outline of the wearer, all shown in broken lines, form no part of the design.**

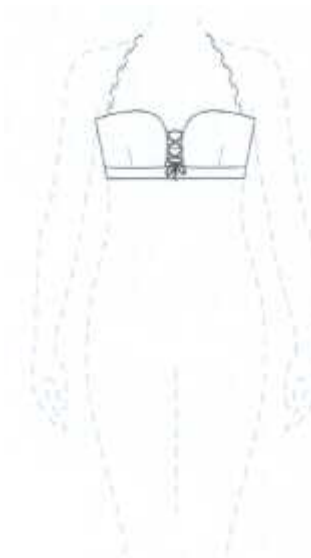

- (21) Design Number: **11063/2012**
(22) Date of Filing Application: **05 March 2012**
(24) Date from which industrial property rights may have effect: **05 March 2012**
(54) Product in respect of which the design is registered: **Swimwear garment**
(51) International Design Classification: **02-02A**
(74) Name(s) of Attorney(s):
(71) Name(s) and Address(s) of Applicant(s):
JETS Swimwear Pty Limited
8-18 Bowden Street Alexandria New South Wales 2015 Australia
(72) Name(s) of Designer(s): **Jessika Allen**
(45) Registration Date: **16 April 2012**
(56) Related Art Documents: **Not Applicable**
(57) Statement of Newness and Distinctiveness: **Newness and distinctiveness is claimed in the shape, configuration, pattern and/or ornamentation of the swimwear garment as depicted in the accompanying representations. In considering the newness and distinctiveness of the design, the lines under the bust shown in the front view, as indicated at "A" and the tie shown in the back view, as indicated at "A" are to be disregarded. The back straps and the outline of the wearer, all shown in broken lines, form no part of the design.**

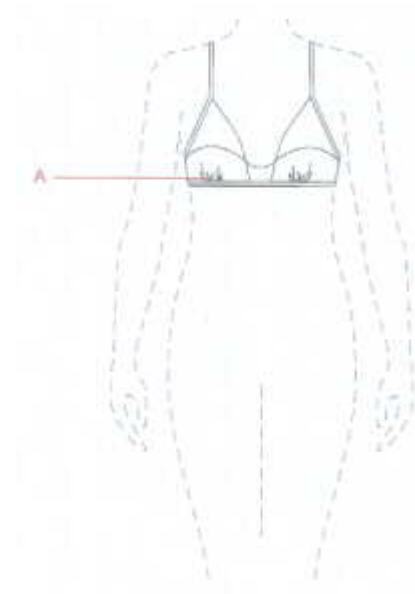

- (21) Design Number: **11064/2012**
(22) Date of Filing Application: **05 March 2012**
(24) Date from which industrial property rights may have effect: **05 March 2012**
(54) Product in respect of which the design is registered: **Swimwear garment**
(51) International Design Classification: **02-02A**
(74) Name(s) of Attorney(s):
(71) Name(s) and Address(s) of Applicant(s):

JETS Swimwear Pty Limited
8-18 Bowden Street Alexandria New South Wales 2015 Australia

(72) Name(s) of Designer(s): **Jessika Allen**

(45) Registration Date: **16 April 2012**

(56) Related Art Documents: **Not Applicable**

(57) Statement of Newness and Distinctiveness: **Newness and distinctiveness is claimed in the shape, configuration, pattern and/or ornamentation of the reversible swimwear garment as depicted in the accompanying representations. In considering the newness and distinctiveness of the design, the lines shown in the front view, as indicated at "A" are to be disregarded. The front and back straps, the bow in the back view, and the outline of the wearer, all shown in broken lines, form no part of the design.**

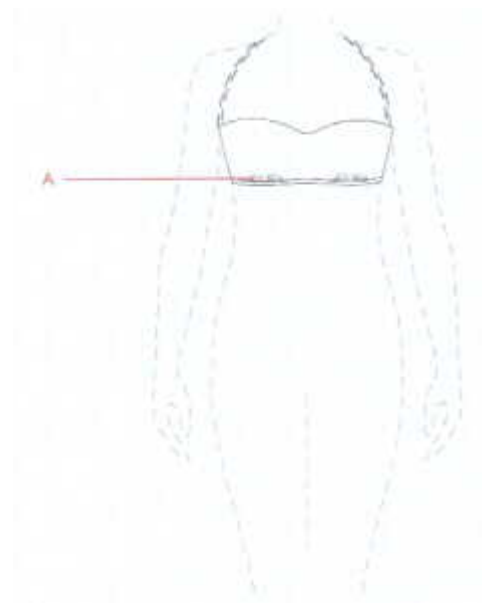

- (21) Design Number: **11065/2012**
(22) Date of Filing Application: **05 March 2012**
(24) Date from which industrial property rights may have effect: **05 March 2012**
(54) Product in respect of which the design is registered: **Swimwear garment**
(51) International Design Classification: **02-02A**
(74) Name(s) of Attorney(s):
(71) Name(s) and Address(s) of Applicant(s):

JETS Swimwear Pty Limited
8-18 Bowden Street Alexandria New South Wales 2015 Australia

(72) Name(s) of Designer(s): **Jessika Allen**

(45) Registration Date: **16 April 2012**

(56) Related Art Documents: **Not Applicable**

(57) Statement of Newness and Distinctiveness: **Newness and distinctiveness is claimed in the shape, configuration, pattern and/or ornamentation of the swimwear garment as depicted in the accompanying representations. In considering the newness and distinctiveness of the design, the gathered lines in the central panel in the front view, as indicated at "A", are to be disregarded. The back neck strap, both ties in the back view, and the outline of the wearer, all shown in broken lines, form no part of the design.**

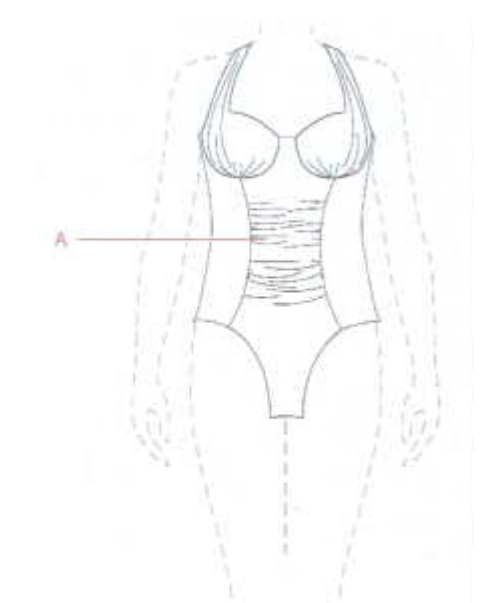

- (21) Design Number: **11066/2012**
(22) Date of Filing Application: **05 March 2012**
(24) Date from which industrial property rights may have effect: **05 March 2012**
(54) Product in respect of which the design is registered: **Swimwear garment**
(51) International Design Classification: **02-02A**
(74) Name(s) of Attorney(s):
(71) Name(s) and Address(s) of Applicant(s):
JETS Swimwear Pty Limited
8-18 Bowden Street Alexandria New South Wales 2015 Australia
(72) Name(s) of Designer(s): **Jessika Allen**
(45) Registration Date: **16 April 2012**
(56) Related Art Documents: **Not Applicable**
(57) Statement of Newness and Distinctiveness: **Newness and distinctiveness is claimed in the shape, configuration, pattern and/or ornamentation of the swimwear garment with a cowl neckline as depicted in the accompanying representations. In considering the newness and distinctiveness of the design, the lines at the bust and lines on the torso shown in the front view, as indicated at "A" are to be disregarded. The back neck strap, both ties in the back view, and the outline of the wearer, all shown in broken lines, form no part of the design.**

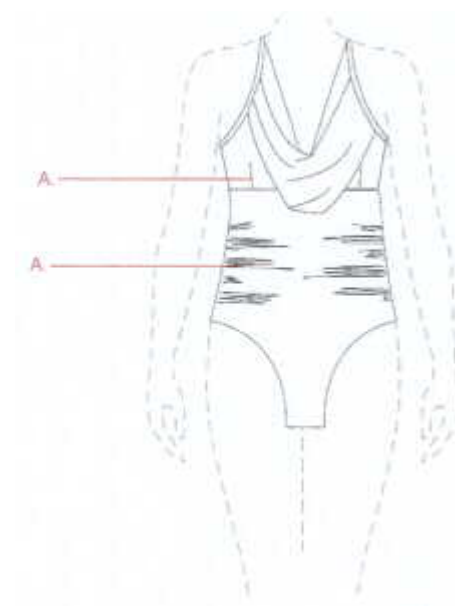

- (21) Design Number: **11067/2012**
(22) Date of Filing Application: **05 March 2012**
(24) Date from which industrial property rights may have effect: **05 March 2012**
(54) Product in respect of which the design is registered: **Swimwear garment**
(51) International Design Classification: **02-02A**
(74) Name(s) of Attorney(s):
(71) Name(s) and Address(s) of Applicant(s):
JETS Swimwear Pty Limited
8-18 Bowden Street Alexandria New South Wales 2015 Australia
(72) Name(s) of Designer(s): **Jessika Allen**
(45) Registration Date: **16 April 2012**
(56) Related Art Documents: **Not Applicable**
(57) Statement of Newness and Distinctiveness: **Newness and distinctiveness is claimed in the shape, configuration, pattern and/or ornamentation of the swimwear garment as depicted in the accompanying representations. The outline of the wearer shown in broken lines forms no part of the design.**

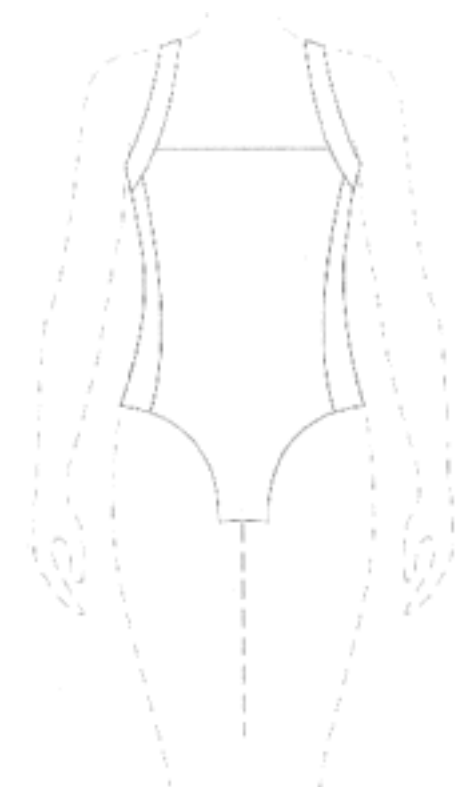

- (21) Design Number: **11068/2012**
(22) Date of Filing Application: **05 March 2012**
(24) Date from which industrial property rights may have effect: **05 March 2012**
(54) Product in respect of which the design is registered: **Swimwear garment**
(51) International Design Classification: **02-02A**
(74) Name(s) of Attorney(s):
(71) Name(s) and Address(s) of Applicant(s):
JETS Swimwear Pty Limited
8-18 Bowden Street Alexandria New South Wales 2015 Australia
(72) Name(s) of Designer(s): **Jessika Allen**
(45) Registration Date: **16 April 2012**
(56) Related Art Documents: **Not Applicable**
(57) Statement of Newness and Distinctiveness: **Newness and distinctiveness is claimed in the shape, configuration, pattern and/or ornamentation of the swimwear garment with a draped neckline as depicted in the accompanying representations. The back neck strap, the tie in the back view, and the outline of the wearer, all shown in broken lines, form no part of the design.**



- (21) Design Number: **11069/2012**
(22) Date of Filing Application: **05 March 2012**
(24) Date from which industrial property rights may have effect: **05 March 2012**
(54) Product in respect of which the design is registered: **Swimwear garment**
(51) International Design Classification: **02-02A**
(74) Name(s) of Attorney(s):
(71) Name(s) and Address(s) of Applicant(s):
JETS Swimwear Pty Limited
8-18 Bowden Street Alexandria New South Wales 2015 Australia
(72) Name(s) of Designer(s): **Jessika Allen**
(45) Registration Date: **16 April 2012**
(56) Related Art Documents: **Not Applicable**
(57) Statement of Newness and Distinctiveness: **Newness and distinctiveness is claimed in the shape, configuration, pattern and/or ornamentation of the swimwear garment as depicted in the accompanying representations. In considering the newness and distinctiveness of the design, consideration is to be given to the detail as indicated at "B" namely the contrast fabric entwined with the fabric that comprises the neck strap and neckline to the bust-line and which creates the appearance of a rope. The garment is shown in a striped fabric, but the design is claimed for all fabric colours and prints. In considering the newness and distinctiveness of the design, the band under the bust shown in the front view and the strap and tie at the neck and mid-back on the back view, as indicated at "A", are to be disregarded.**



- (21) Design Number: **11070/2012**
(22) Date of Filing Application: **05 March 2012**
(24) Date from which industrial property rights may have effect: **05 March 2012**
(54) Product in respect of which the design is registered: **Swimwear garment**
(51) International Design Classification: **02-02A**
(74) Name(s) of Attorney(s):
(71) Name(s) and Address(s) of Applicant(s):

JETS Swimwear Pty Limited
8-18 Bowden Street Alexandria New South Wales 2015 Australia

(72) Name(s) of Designer(s): **Jessika Allen**

(45) Registration Date: **16 April 2012**

(56) Related Art Documents: **Not Applicable**

(57) Statement of Newness and Distinctiveness: **Newness and distinctiveness is claimed in the shape, configuration, pattern and/or ornamentation of the swimwear garment as depicted in the accompanying representations. In considering the newness and distinctiveness of the design, consideration is to be given to the detail as indicated at "B" namely the contrast fabric entwined with the fabric that constitutes the centre front from the neckline to the bust-line and which creates the appearance of a rope. The garment is shown in a striped fabric, but the design is claimed for all fabric colours and prints. In considering the newness and distinctiveness of the design, the strap and tie at the neck and at the mid-back on the back view, as indicated at "A" are to be disregarded.**



- (21) Design Number: **11071/2012**
(22) Date of Filing Application: **05 March 2012**
(24) Date from which industrial property rights may have effect: **05 March 2012**
(54) Product in respect of which the design is registered: **Swimwear garment**
(51) International Design Classification: **02-02A**
(74) Name(s) of Attorney(s):
(71) Name(s) and Address(s) of Applicant(s):

JETS Swimwear Pty Limited
8-18 Bowden Street Alexandria New South Wales 2015 Australia

(72) Name(s) of Designer(s): **Jessika Allen**

(45) Registration Date: **16 April 2012**

(56) Related Art Documents: **Not Applicable**

(57) Statement of Newness and Distinctiveness: **Newness and distinctiveness is claimed in the shape, configuration, pattern and/or ornamentation of the swimwear garment as depicted in the accompanying representations. In considering the newness and distinctiveness of the design, consideration is to be given to the detail as indicated at "B" namely the contrast fabric entwined with the fabric that constitutes the top of the pant and which created the appearance of a rope. The garment is shown in a striped fabric, but the design is claimed for all fabric colours and prints. In considering the newness and distinctiveness of the design, the tags on the front view and the tags and toggles on the back view, as indicated at "A" are to be disregarded.**



- (21) Design Number: **11072/2012**
(22) Date of Filing Application: **05 March 2012**
(24) Date from which industrial property rights may have effect: **05 March 2012**
(54) Product in respect of which the design is registered: **Swimwear garment**
(51) International Design Classification: **02-02A**
(74) Name(s) of Attorney(s):
(71) Name(s) and Address(s) of Applicant(s):
JETS Swimwear Pty Limited
8-18 Bowden Street Alexandria New South Wales 2015 Australia
(72) Name(s) of Designer(s): **Jessika Allen**
(45) Registration Date: **16 April 2012**
(56) Related Art Documents: **Not Applicable**
(57) Statement of Newness and Distinctiveness: **Newness and distinctiveness is claimed in the shape, configuration, pattern and/or ornamentation of the swimwear garment as depicted in the accompanying representations. In considering the newness and distinctiveness of the design, the back straps, the tie in the back view, and the outline of the wearer, all shown in broken lines, form no part of the design.**



- (21) Design Number: **11073/2012**
(22) Date of Filing Application: **05 March 2012**
(24) Date from which industrial property rights may have effect: **05 March 2012**
(54) Product in respect of which the design is registered: **Swimwear garment**
(51) International Design Classification: **02-02A**
(74) Name(s) of Attorney(s):
(71) Name(s) and Address(s) of Applicant(s):
JETS Swimwear Pty Limited
8-18 Bowden Street Alexandria New South Wales 2015 Australia
(72) Name(s) of Designer(s): **Jessika Allen**
(45) Registration Date: **16 April 2012**
(56) Related Art Documents: **Not Applicable**
(57) Statement of Newness and Distinctiveness: **Newness and distinctiveness is claimed in the shape, configuration, pattern and/or ornamentation of the swimwear garment as depicted in the accompanying representations. In considering the newness and distinctiveness of the design, the outline of the wearer shown in broken lines forms no part of the design.**



- (21) Design Number: **11074/2012**
(22) Date of Filing Application: **05 March 2012**
(24) Date from which industrial property rights may have effect: **05 March 2012**
(54) Product in respect of which the design is registered: **Swimwear garment**
(51) International Design Classification: **02-02A**
(74) Name(s) of Attorney(s):
(71) Name(s) and Address(s) of Applicant(s):

JETS Swimwear Pty Limited
8-18 Bowden Street Alexandria New South Wales 2015 Australia

(72) Name(s) of Designer(s): **Jessika Allen**

(45) Registration Date: **16 April 2012**

(56) Related Art Documents: **Not Applicable**

(57) Statement of Newness and Distinctiveness: **Newness and distinctiveness is claimed in the shape, configuration, pattern and/or ornamentation of the swimwear garment as depicted in the accompanying representations. In considering the newness and distinctiveness of the design, the lines at bust shown in the front view, as indicated at "A", are to be disregarded. The back neck strap, the tie in the back view, and the outline of wearer, all shown in broken lines, form no part of the design.**

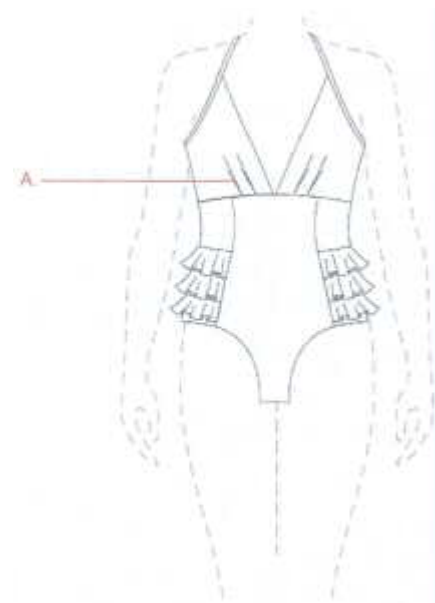

- (21) Design Number: **13438/2011**
(22) Date of Filing Application: **03 August 2011**
(24) Date from which industrial property rights may have effect: **03 August 2011**
(54) Product in respect of which the design is registered: **Container**
(51) International Design Classification: **09-03NES**
(74) Name(s) of Attorney(s): **Allens Arthur Robinson**
(71) Name(s) and Address(s) of Applicant(s):

NCI Holdings Pty Ltd
24 Groom Street Clifton Hill Victoria 3068 Australia

(72) Name(s) of Designer(s): **George Orfali**

(45) Registration Date: **16 April 2012**

(56) Related Art Documents: **Not Applicable**

(57) Statement of Newness and Distinctiveness: **Newness and distinctiveness resides in the visual features of shape and/or configuration of a container as illustrated in the accompanying representations.**

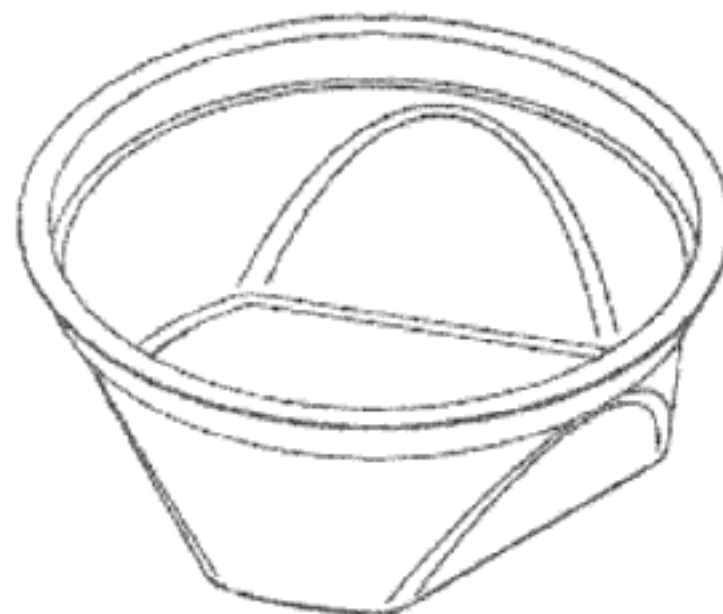

- (21) Design Number: **13439/2011**
(22) Date of Filing Application: **03 August 2011**
(24) Date from which industrial property rights may have effect: **03 August 2011**
(54) Product in respect of which the design is registered: **Container**
(51) International Design Classification: **09-03NES**
(74) Name(s) of Attorney(s): **Allens Arthur Robinson**
(71) Name(s) and Address(s) of Applicant(s):
NCI Holdings Pty Ltd
24 Groom Street Clifton Hill Victoria 3068 Australia
(72) Name(s) of Designer(s): **George Orfali**
(45) Registration Date: **16 April 2012**
(56) Related Art Documents: **Not Applicable**
(57) Statement of Newness and Distinctiveness: **Newness and distinctiveness resides in the visual features of shape and/or configuration of a container as illustrated in the accompanying representations.**

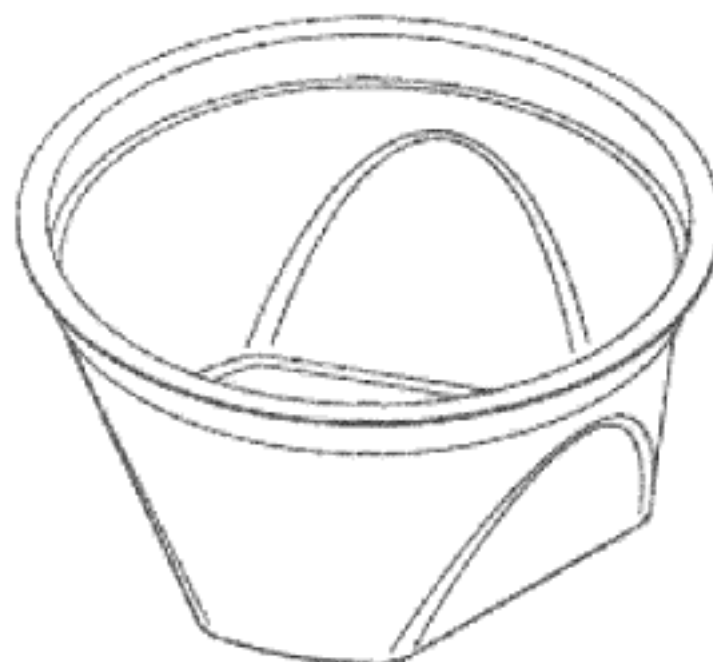

- (21) Design Number: **13440/2011**
(22) Date of Filing Application: **03 August 2011**
(24) Date from which industrial property rights may have effect: **03 August 2011**
(54) Product in respect of which the design is registered: **Container**
(51) International Design Classification: **09-03NES**
(74) Name(s) of Attorney(s): **Allens Arthur Robinson**
(71) Name(s) and Address(s) of Applicant(s):
NCI Holdings Pty Ltd
24 Groom Street Clifton Hill Victoria 3068 Australia
(72) Name(s) of Designer(s): **George Orfali**
(45) Registration Date: **16 April 2012**
(56) Related Art Documents: **Not Applicable**
(57) Statement of Newness and Distinctiveness: **Newness and distinctiveness resides in the visual features of shape and/or configuration of a container as illustrated in the accompanying representations.**

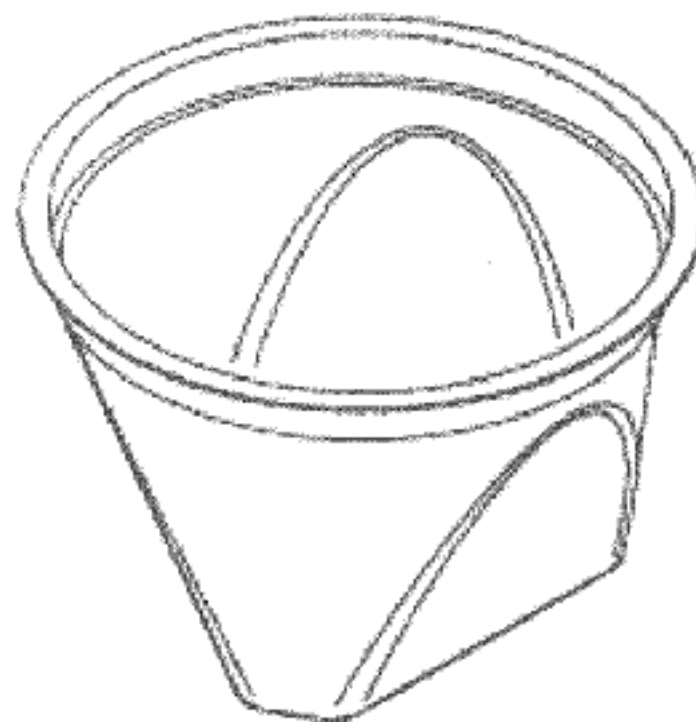

(21) Design Number: **13701/2011**
(22) Date of Filing Application: **19 August 2011**
(24) Date from which industrial property rights may have effect: **19 August 2011**
(54) Product in respect of which the design is registered: **Bin**
(51) International Design Classification: **09-09**
(74) Name(s) of Attorney(s): **Davies Collison Cave**
(71) Name(s) and Address(s) of Applicant(s):
Willow Ware Australia Pty Ltd
60 Annandale Road Melbourne Airport Victoria 3045 Australia
(72) Name(s) of Designer(s): **David Flynn and Giovanni Ciampa**
(45) Registration Date: **16 April 2012**
(56) Related Art Documents: **Not Applicable**
(57) Statement of Newness and Distinctiveness: **Nil**

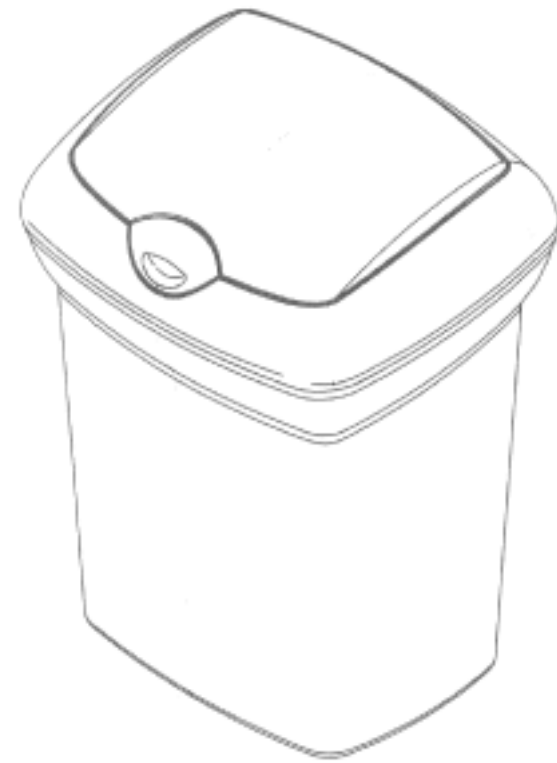

(21) Design Number: **10250/2012**
(22) Date of Filing Application: **23 January 2012**
(24) Date from which industrial property rights may have effect: **23 January 2012**
(54) Product in respect of which the design is registered: **Wool and wool-mesh underarmour shirt**
(51) International Design Classification: **02-02NES**
(74) Name(s) of Attorney(s):
(71) Name(s) and Address(s) of Applicant(s):
Rammite Pty Ltd Trading as Missionpac
14 Mann Place Roleystone Western Australia 6111 Australia
(72) Name(s) of Designer(s): **Ian Glyde**
(45) Registration Date: **16 April 2012**
(56) Related Art Documents: **Not Applicable**
(57) Statement of Newness and Distinctiveness: **The combination of design and integration of both wool and wool-mesh in the design.**



- (21) Design Number: **10587/2012**
(22) Date of Filing Application: **07 February 2012**
(24) Date from which industrial property rights may have effect: **07 February 2012**
(54) Product in respect of which the design is registered: **Handpiece for a hand blender**
(51) International Design Classification: **31-00**
(74) Name(s) of Attorney(s): **PHILLIPS ORMONDE FITZPATRICK**
(71) Name(s) and Address(s) of Applicant(s):
Braun GmbH
Frankfurter Strasse 145 61476 Kronberg am Taunus Germany
(72) Name(s) of Designer(s): **Oliver Grabes and Christine Hielscher and Rory McGarry and Sven Wuttig and Phong Duy Vu and Benjamin John Wilson**
(45) Registration Date: **16 April 2012**
(30) Convention priority data:
(31) Number (32) Date (33) Country
DM/076554 08 Aug 2011 WORLD INTELLECTUAL PROPERTY ORGANIZATION (WIPO)
(56) Related Art Documents: **Not Applicable**
(57) Statement of Newness and Distinctiveness: **Those features of the handpiece of a hand blender depicted in the representations that are new and distinctive are the shape and/or configuration. The "Braun" logo, lock symbol and symbol on the switch together with the cord of the handpiece for a hand blender are not part of the design and is to be disregarded when considering the overall impression of the design.**



- (21) Design Number: **11474/2012**
(22) Date of Filing Application: **21 March 2012**
(24) Date from which industrial property rights may have effect: **21 March 2012**
(54) Product in respect of which the design is registered: **Vehicular LED lighting fixture**
(51) International Design Classification: **26-06**
(74) Name(s) of Attorney(s): **PIZZEYS**
(71) Name(s) and Address(s) of Applicant(s):
Stephen Adams
4641 E. Ivy Mesa AZ 85215 United States of America
(72) Name(s) of Designer(s): **Stephen Adams**
(45) Registration Date: **16 April 2012**
(30) Convention priority data:
(31) Number (32) Date (33) Country
29/402202 21 Sep 2011 UNITED STATES OF AMERICA
(56) Related Art Documents: **Not Applicable**
(57) Statement of Newness and Distinctiveness: **The newness and distinctiveness of the design resides in the features of pattern and/or ornamentations OR shape and/or configuration shown in unbroken lines in the accompanying representations. (if required, see Convention document)**

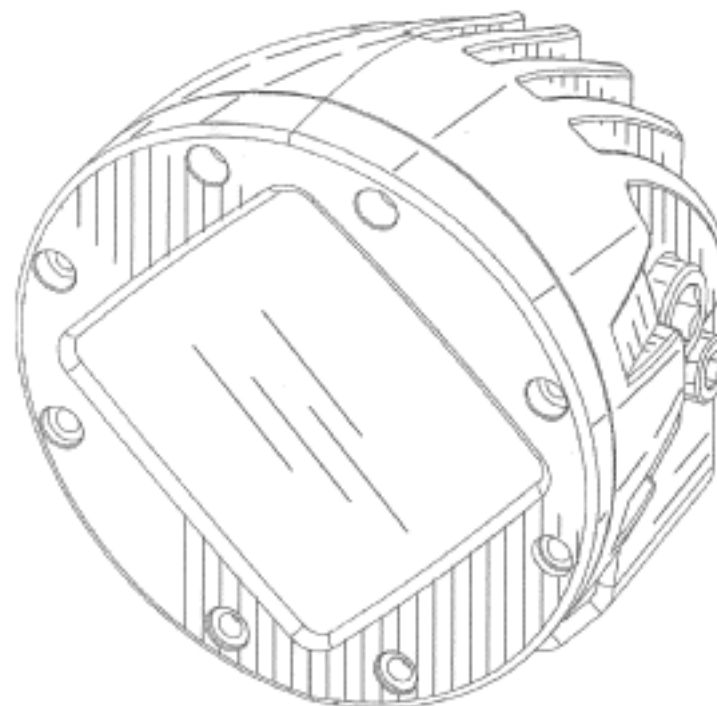

- (21) Design Number: **11211/2012**
(22) Date of Filing Application: **07 March 2012**
(24) Date from which industrial property rights may have effect: **07 March 2012**
(54) Product in respect of which the design is registered: **Display screen with user interface**
(51) International Design Classification: **14-04**
(74) Name(s) of Attorney(s): **Shelston IP**
(71) Name(s) and Address(s) of Applicant(s):
Microsoft Corporation
One Microsoft Way Redmond Washington 98052 United States of America
(72) Name(s) of Designer(s): **William Yang and Sander M. Viegers and Leslie Christine MacNeal**
(45) Registration Date: **16 April 2012**
(30) Convention priority data:
(31) Number (32) Date (33) Country
29/401449 12 Sep 2011 UNITED STATES OF AMERICA
(56) Related Art Documents: **Not Applicable**
(57) Statement of Newness and Distinctiveness: **Newness and distinctiveness reside in the pattern and/or ornamentation of a display screen with user interface as illustrated by solid lines in the accompanying representations. The features shown in broken outline are for illustrative purposes only and do not form part of the design.**

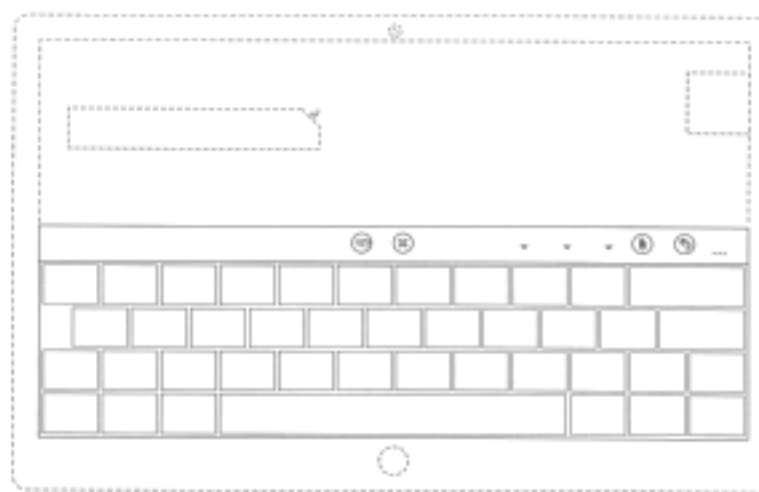

- (21) Design Number: **11212/2012**
(22) Date of Filing Application: **07 March 2012**
(24) Date from which industrial property rights may have effect: **07 March 2012**
(54) Product in respect of which the design is registered: **Display screen with user interface**
(51) International Design Classification: **14-04**
(74) Name(s) of Attorney(s): **Shelston IP**
(71) Name(s) and Address(s) of Applicant(s):
Microsoft Corporation
One Microsoft Way Redmond Washington 98052 United States of America
(72) Name(s) of Designer(s): **Jodene Lynn Eikenberry and Rishad Madhura Kuzhiyil and Joseph W. Hallock and Brian Peter Oakley and Benjamin Homelson Meister and Leslie Christine MacNeal**
(45) Registration Date: **16 April 2012**
(30) Convention priority data:
(31) Number (32) Date (33) Country
29/401527 12 Sep 2011 UNITED STATES OF AMERICA
(56) Related Art Documents: **Not Applicable**
(57) Statement of Newness and Distinctiveness: **Newness and distinctiveness reside in the pattern and/or ornamentation of a display screen with user interface as illustrated by solid lines in the accompanying representations. The features shown in broken outline are for illustrative purposes only and do not form part of the design.**



- (21) Design Number: **11213/2012**
(22) Date of Filing Application: **07 March 2012**
(24) Date from which industrial property rights may have effect: **07 March 2012**
(54) Product in respect of which the design is registered: **Display screen with user interface**
(51) International Design Classification: **14-04**
(74) Name(s) of Attorney(s): **Shelston IP**
(71) Name(s) and Address(s) of Applicant(s):
Microsoft Corporation
One Microsoft Way Redmond Washington 98052 United States of America
(72) Name(s) of Designer(s): **William Yang and Sander M. Viegers and Keith Fournier and Leslie Christine MacNeal**
(45) Registration Date: **16 April 2012**
(30) Convention priority data:
(31) Number (32) Date (33) Country
29/401436 12 Sep 2011 UNITED STATES OF AMERICA
(56) Related Art Documents: **Not Applicable**
(57) Statement of Newness and Distinctiveness: **Newness and distinctiveness reside in the pattern and/or ornamentation of a display screen with user interface as illustrated by solid lines in the accompanying representations. The features shown in broken outline are for illustrative purposes only and do not form part of the design.**

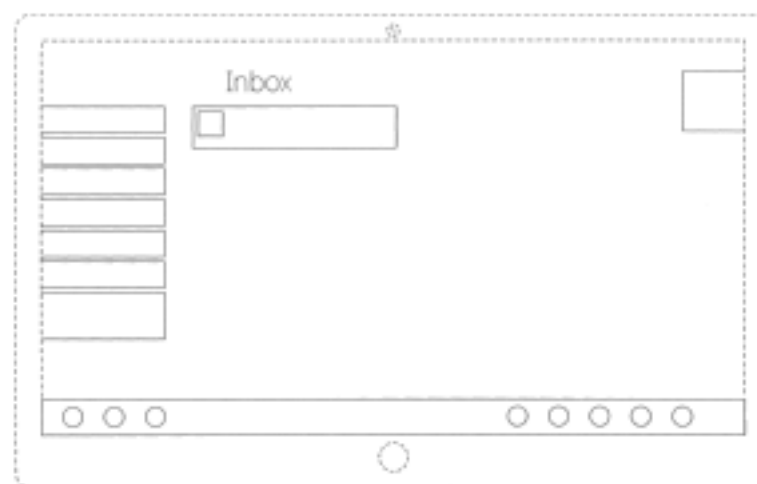

- (21) Design Number: **11214/2012**
(22) Date of Filing Application: **07 March 2012**
(24) Date from which industrial property rights may have effect: **07 March 2012**
(54) Product in respect of which the design is registered: **Display screen with user interface**
(51) International Design Classification: **14-04**
(74) Name(s) of Attorney(s): **Shelston IP**
(71) Name(s) and Address(s) of Applicant(s):
Microsoft Corporation
One Microsoft Way Redmond Washington 98052 United States of America
(72) Name(s) of Designer(s): **William Yang and Sander M. Viegers and Keith Fournier and Leslie Christine MacNeal**
(45) Registration Date: **16 April 2012**
(30) Convention priority data:
(31) Number (32) Date (33) Country
29/401537 12 Sep 2011 UNITED STATES OF AMERICA
(56) Related Art Documents: **Not Applicable**
(57) Statement of Newness and Distinctiveness: **Newness and distinctiveness reside in the pattern and/or ornamentation of a display screen with user interface as illustrated by solid lines in the accompanying representations. The features shown in broken outline are for illustrative purposes only and do not form part of the design.**

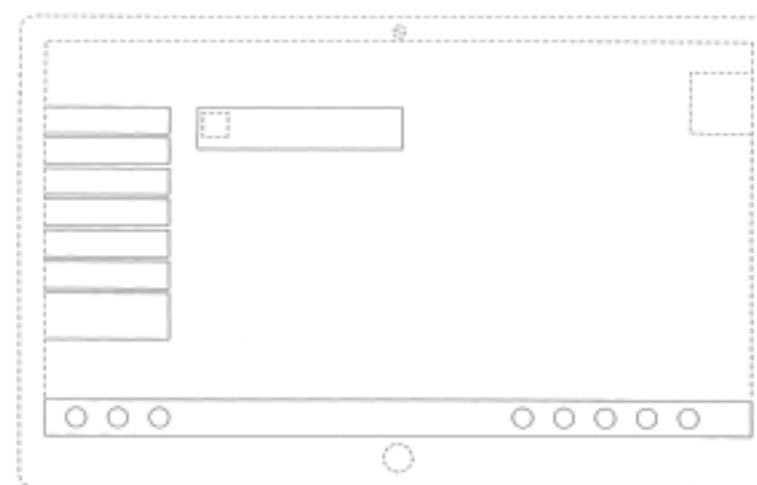

(21) Design Number: **11215/2012**
(22) Date of Filing Application: **07 March 2012**
(24) Date from which industrial property rights may have effect: **07 March 2012**
(54) Product in respect of which the design is registered: **Display screen with icon**
(51) International Design Classification: **14-04**
(74) Name(s) of Attorney(s): **Shelston IP**
(71) Name(s) and Address(s) of Applicant(s):

Microsoft Corporation
One Microsoft Way Redmond Washington 98052 United States of America

(72) Name(s) of Designer(s): **Kieran Phelan**

(45) Registration Date: **16 April 2012**

(30) Convention priority data:

(31) Number	(32) Date	(33) Country
29/401390	12 Sep 2011	UNITED STATES OF AMERICA

(56) Related Art Documents: **Not Applicable**

(57) Statement of Newness and Distinctiveness: **Newness and distinctiveness reside in the pattern and/or ornamentation of a display screen with icon as illustrated by solid lines in the accompanying representations. The features shown in broken outline are for illustrative purposes only and do not form part of the design.**

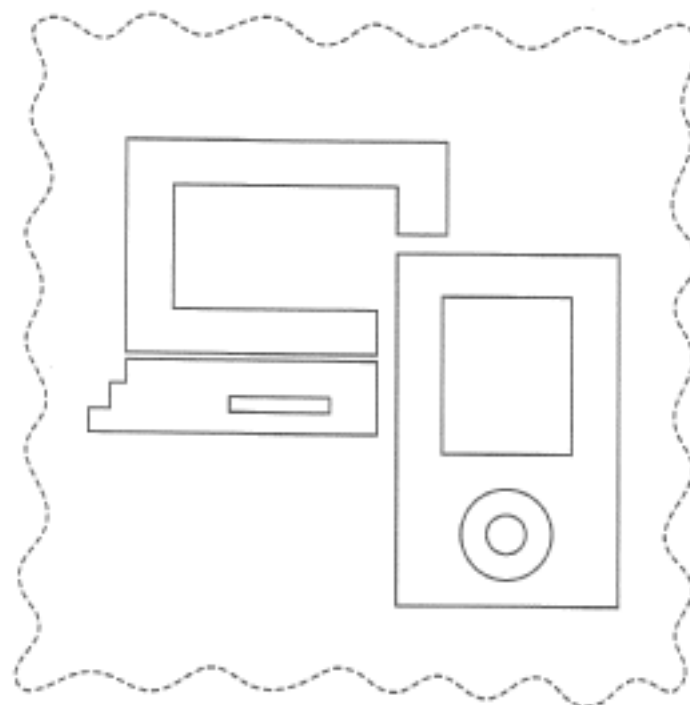

(21) Design Number: **10837/2012**
(22) Date of Filing Application: **22 February 2012**
(24) Date from which industrial property rights may have effect: **22 February 2012**
(54) Product in respect of which the design is registered: **A support device for hot water storage systems**
(51) International Design Classification: **23-03H**
(74) Name(s) of Attorney(s):
(71) Name(s) and Address(s) of Applicant(s):

Ty Gerard Hermans
2A Duffield Road Margate Queensland 4019 Australia

(72) Name(s) of Designer(s): **Ty Gerard Hermans**

(45) Registration Date: **16 April 2012**

(56) Related Art Documents: **Not Applicable**

(57) Statement of Newness and Distinctiveness: **Newness and distinctiveness is claimed in the features of shape and configuration of the equipment support as illustrated in the accompanying representations.**

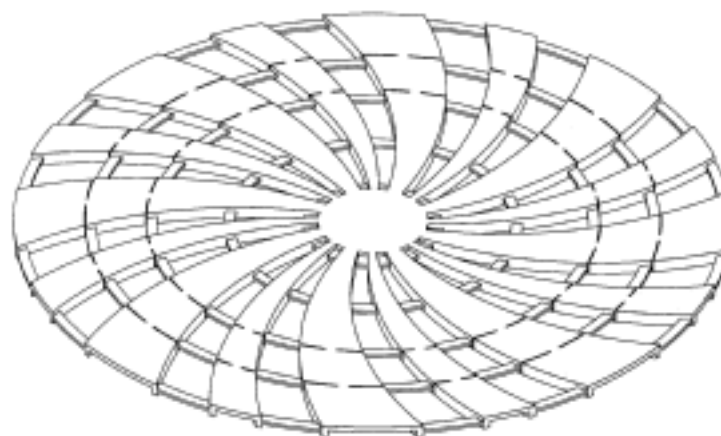

- (21) Design Number: **11014/2012**
- (22) Date of Filing Application: **29 February 2012**
- (24) Date from which industrial property rights may have effect: **29 February 2012**
- (54) Product in respect of which the design is registered: **Digital media presentation kiosk**
- (51) International Design Classification: **20-02NES, 14-02**
- (74) Name(s) of Attorney(s):
- (71) Name(s) and Address(s) of Applicant(s):
Heine Jones Studio Pty Ltd
26 Murray Street Yarraville Victoria 3013 Australia
- (72) Name(s) of Designer(s): **Mike Heine and Steve Jones and Peter Hvala**
- (45) Registration Date: **16 April 2012**
- (56) Related Art Documents: **Not Applicable**
- (57) Statement of Newness and Distinctiveness: **Digital Media Presentation Kiosk Monopoly is claimed on the distinct three sided configuration and design of a Digital Media Presentation Kiosk. This apparatus is specially designed to be table mounted, portable, visually appealing and minimalist. The Digital Media Presentation kiosk is generally constructed from plastic, metal or glass component parts and contains necessary electrical components to drive the integrated LCD, Plasma or other suitable digital display screen/s. The general shape, size and proportions of the Digital Media Presentation Kiosk, as illustrated in this application, are distinct and unique, as is the functionality as a Digital Media Presentation Kiosk . Apart from the base, the integrated digital screen/ s extends towards every edge and corner or across surfaces creating a maximum screen viewing area. Each screen is generally flat or may exhibit a subtle curve around the longitudinal axis for styling. This results in visually modern, clean and unobstructed surfaces. The display screens and adaptable technologies are not limited to LCD, plasma or flexible flat screen types or in technological specification such as full surface interactive digital touch, 3D, haptic feedback or wireless interfacing. With reference to the design illustrations provided with this application, these particular technologies are adaptable and configurable to the forms presented, depending on customer and technologies available. Generally, thin layer type screens with the widest possible viewing angles are most desirable for integration into this product.**

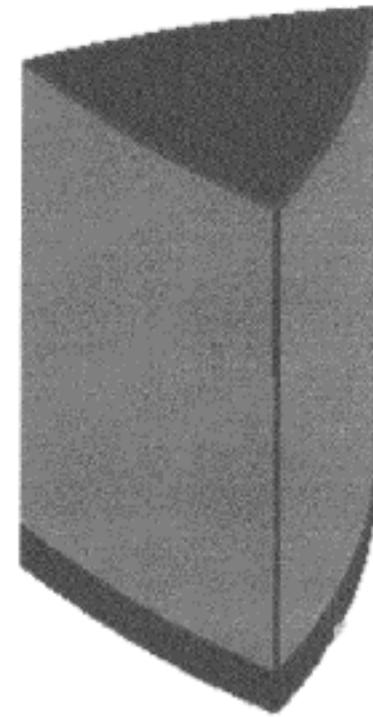

- (21) Design Number: **11015/2012**
- (22) Date of Filing Application: **29 February 2012**
- (24) Date from which industrial property rights may have effect: **29 February 2012**
- (54) Product in respect of which the design is registered: **Digital media presentation kiosk**
- (51) International Design Classification: **20-02NES, 14-02**
- (74) Name(s) of Attorney(s):
- (71) Name(s) and Address(s) of Applicant(s):
Heine Jones Studio Pty Ltd
26 Murray Street Yarraville Victoria 3013 Australia
- (72) Name(s) of Designer(s): **Mike Heine and Steve Jones and Peter Hvala**
- (45) Registration Date: **16 April 2012**
- (56) Related Art Documents: **Not Applicable**
- (57) Statement of Newness and Distinctiveness: **Digital Media Presentation Kiosk Monopoly is claimed on the distinct four sided configuration and design of a Digital Media Presentation Kiosk. This apparatus is specially designed to be table mounted, portable, visually appealing and minimalist. The Digital Media Presentation Kiosk is generally constructed from plastic, metal or glass component parts and contains necessary electrical components to drive the integrated LCD, Plasma or other suitable digital display screen/s. The general shape, size and proportions of the Digital Media Presentation Kiosk, as illustrated in this application, are distinct and unique, as is the functionality as a Digital Media Presentation Kiosk. Apart from the base, the integrated digital screen/s extends towards every edge and corner or across surfaces creating a maximum screen viewing area. Each screen is generally flat or may exhibit a subtle curve around the longitudinal axis for styling. This results in visually modern, clean and unobstructed surfaces. The display screens and adaptable technologies are not limited to LCD, plasma or flexible flat screen types or in technological specification such as full surface interactive digital touch, 3D, haptic feedback or wireless interfacing. With reference to the design illustrations provided with this application, these particular technologies are adaptable and configurable to the forms presented, depending on customer requirements and technologies available. Generally, thin layer type screens with the widest possible viewing angles are most desirable for integration into this product.**

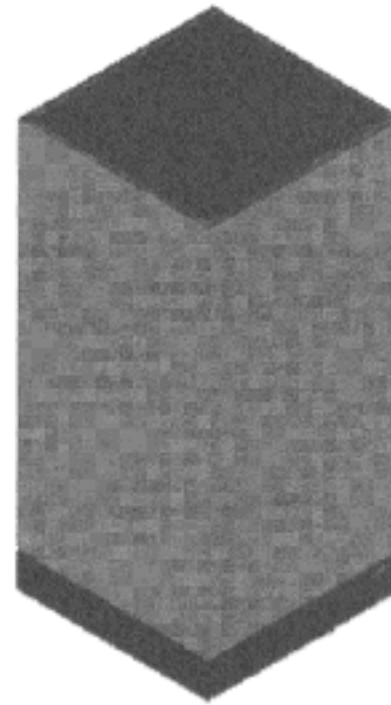

- (21) Design Number: **11016/2012**
- (22) Date of Filing Application: **29 February 2012**
- (24) Date from which industrial property rights may have effect: **29 February 2012**
- (54) Product in respect of which the design is registered: **Digital media presentation kiosk**
- (51) International Design Classification: **20-02NES, 14-02**
- (74) Name(s) of Attorney(s):
- (71) Name(s) and Address(s) of Applicant(s):
Heine Jones Studio Pty Ltd
26 Murray Street Yarraville Victoria 3013 Australia
- (72) Name(s) of Designer(s): **Mike Heine and Steve Jones and Peter Hvala**
- (45) Registration Date: **16 April 2012**
- (56) Related Art Documents: **Not Applicable**
- (57) Statement of Newness and Distinctiveness: **Digital Media Presentation Kiosk Monopoly is claimed on the distinct vertical tube configuration and design of a Digital Media Presentation Kiosk. This apparatus is specially designed to be table mounted, portable, visually appealing and minimalist. The Digital Media Presentation Kiosk is generally constructed from plastic, metal or glass component parts and contains necessary electrical components to drive the integrated LCD, Plasma or other suitable digital display screen/s. The general shape, size and proportions of the Digital Media Presentation Kiosk, as illustrated in this application, are distinct and unique, as is the functionality as a Digital Media Presentation Kiosk. Apart from the base, the integrated digital screen/s extends towards every edge and corner or across surfaces creating a maximum screen viewing area. Each screen is generally flat or may exhibit a subtle curve around the longitudinal axis for styling. This results in visually modern, clean and unobstructed surfaces . The display screen/s and adaptable technologies are not limited to LCD, plasma or flexible flat screen types or in technological specification such as full surface interactive digital touch, 3D, haptic feedback or wireless interfacing. With reference to the design illustrations provided with this application, these particular technologies are adaptable and configurable to the forms presented, depending on customer requirements and technologies available. Generally, thin layer type screens with the widest possible viewing angles are most desirable for integration into this product**



(21) Design Number: **10247/2012**
(22) Date of Filing Application: **20 January 2012**
(24) Date from which industrial property rights may have effect: **20 January 2012**
(54) Product in respect of which the design is registered: **Radio frequency identification inlay**
(51) International Design Classification: **14-02**
(74) Name(s) of Attorney(s):
(71) Name(s) and Address(s) of Applicant(s):
Avery Dennison Corporation
150 North Orange Grove Boulevard Pasadena California 91103 United States of America
(72) Name(s) of Designer(s): **Sam M. Gladstone**
(45) Registration Date: **17 April 2012**
(30) Convention priority data:
(31) Number (32) Date (33) Country
29/398,522 01 Aug 2011 UNITED STATES OF AMERICA
(56) Related Art Documents: **Not Applicable**
(57) Statement of Newness and Distinctiveness: **Nil**

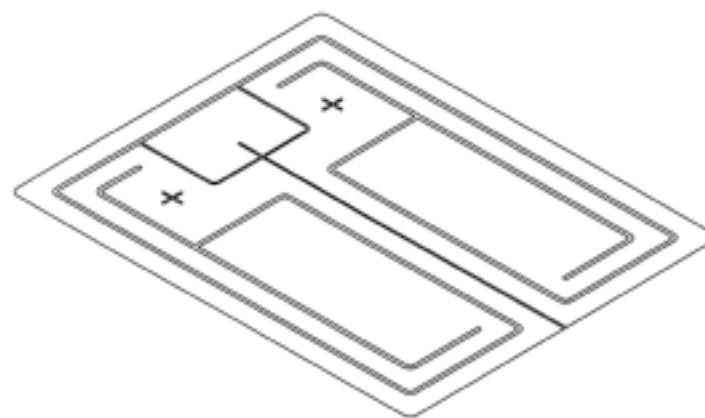

(21) Design Number: **10311/2012**
(22) Date of Filing Application: **24 January 2012**
(24) Date from which industrial property rights may have effect: **24 January 2012**
(54) Product in respect of which the design is registered: **Container with retaining device**
(51) International Design Classification: **09-07A**
(74) Name(s) of Attorney(s): **SPRUSON & FERGUSON**
(71) Name(s) and Address(s) of Applicant(s):
S.C. Johnson & Son, Inc.
1525 Howe Street Racine Wisconsin 53403-2236 United States of America
(72) Name(s) of Designer(s): **Matthew Abbondanzio**
(45) Registration Date: **17 April 2012**
(30) Convention priority data:
(31) Number (32) Date (33) Country
29/398352 29 Jul 2011 UNITED STATES OF AMERICA
(56) Related Art Documents: **Not Applicable**
(57) Statement of Newness and Distinctiveness: **Newness and distinctiveness is claimed in the features of shape and/or configuration of a container with retaining device as illustrated in the accompanying representations.**



- (21) Design Number: **10313/2012**
(22) Date of Filing Application: **24 January 2012**
(24) Date from which industrial property rights may have effect: **24 January 2012**
(54) Product in respect of which the design is registered: **Holder for a cleaning implement**
(51) International Design Classification: **07-05NES, 08-08F**
(74) Name(s) of Attorney(s): **SPRUSON & FERGUSON**
(71) Name(s) and Address(s) of Applicant(s):
S.C. Johnson & Son, Inc.
1525 Howe Street Racine Wisconsin 53403-2236 United States of America
(72) Name(s) of Designer(s): **Douglas A. Soller and Ann Marie Przepasniak and Peter M. Neumann and Eric S. Schwartz and Christopher Peterson and Aaron J. Munsinger**
(45) Registration Date: **17 April 2012**
(30) Convention priority data:
(31) Number (32) Date (33) Country
29/398011 25 Jul 2011 UNITED STATES OF AMERICA
(56) Related Art Documents: **Not Applicable**
(57) Statement of Newness and Distinctiveness: **Newness and distinctiveness is claimed in those features of shape and/or configuration of a holder for a cleaning implement as illustrated in continuous lines in the accompanying representations.**

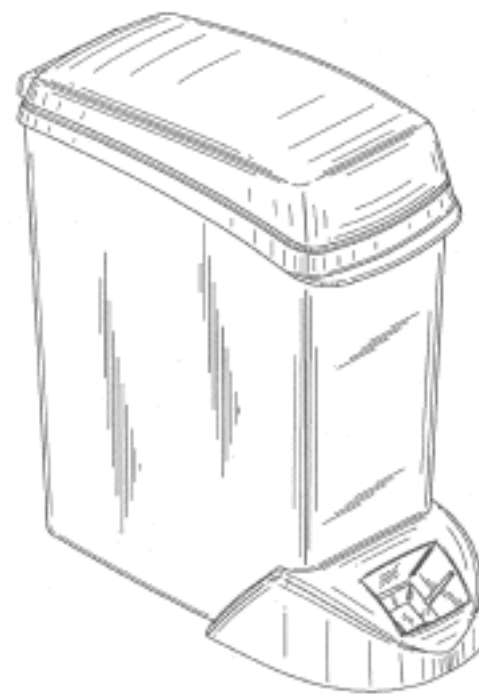

- (21) Design Number: **10802/2012**
(22) Date of Filing Application: **20 February 2012**
(24) Date from which industrial property rights may have effect: **20 February 2012**
(54) Product in respect of which the design is registered: **Lid of cup**
(51) International Design Classification: **09-07B, 07-01NES**
(74) Name(s) of Attorney(s): **Collison & Co**
(71) Name(s) and Address(s) of Applicant(s):
K & Lap Co., Ltd.
(4 fl. Polikem Bldg. Gwanyang- dong) 374 Simin-daero Anyang Si Dongan-gu Gyeonggi-do 431-804 Republic of Korea
(72) Name(s) of Designer(s): **Sung Il Kim**
(45) Registration Date: **17 April 2012**
(30) Convention priority data:
(31) Number (32) Date (33) Country
KR30-2011-35110 23 Aug 2011 REPUBLIC OF KOREA
(56) Related Art Documents: **Not Applicable**
(57) Statement of Newness and Distinctiveness: **Newness and distinctiveness resides in the shape and/or configuration of the lid of a cup as illustrated in the attached representations, excluding the broken lines.**



(21) Design Number: **10922/2012**
(22) Date of Filing Application: **28 February 2012**
(24) Date from which industrial property rights may have effect: **28 February 2012**
(54) Product in respect of which the design is registered: **Footwear**
(51) International Design Classification: **02-04NES**
(74) Name(s) of Attorney(s): **FB Rice**
(71) Name(s) and Address(s) of Applicant(s):
Vibram S.P.A.
Via Cristoforo Colombo 5 I-21041 Albizzate (Varese) Italy
(72) Name(s) of Designer(s): **Marco Bramani and Robert Fliri**
(45) Registration Date: **17 April 2012**
(30) Convention priority data:
(31) Number (32) Date (33) Country
001913930 07 Sep 2011 EUROPEAN COMMUNITY
(56) Related Art Documents: **Not Applicable**
(57) Statement of Newness and Distinctiveness: **Newness and distinctiveness reside in the features of the design as shown in the representations.**



(21) Design Number: **11038/2012**
(22) Date of Filing Application: **29 February 2012**
(24) Date from which industrial property rights may have effect: **29 February 2012**
(54) Product in respect of which the design is registered: **Contoured wall tile**
(51) International Design Classification: **25-01F**
(74) Name(s) of Attorney(s): **HODGKINSON McINNES PATENTS**
(71) Name(s) and Address(s) of Applicant(s):
Woven Image Pty Limited
37-39 Chard Road Brookvale New South Wales 2100 Australia
(72) Name(s) of Designer(s): **Bryan Marshall**
(45) Registration Date: **17 April 2012**
(56) Related Art Documents: **Not Applicable**
(57) Statement of Newness and Distinctiveness: **Newness and distinctiveness is claimed in the shape and configuration and not the surface pattern and ornamentation of a "Contoured Wall Tile" as shown in the attached representations. The ghost lines shown in Figures 10 and 11 merely assist in showing the three-dimensional contours and shape of the wall tile and do not form part of the design.**

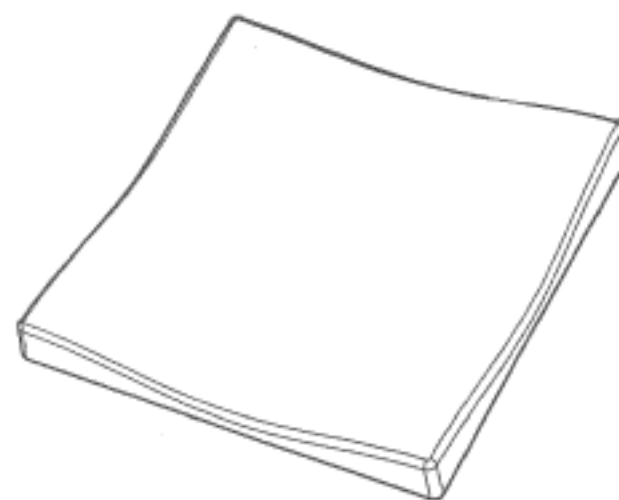

(21) Design Number: **11216/2012**
(22) Date of Filing Application: **07 March 2012**
(24) Date from which industrial property rights may have effect: **07 March 2012**
(54) Product in respect of which the design is registered: **Display screen with icon**
(51) International Design Classification: **14-04**
(74) Name(s) of Attorney(s): **Shelston IP**
(71) Name(s) and Address(s) of Applicant(s):

Microsoft Corporation
One Microsoft Way Redmond Washington 98052 United States of America

(72) Name(s) of Designer(s): **Michael H. LaManna and Patrick Wujcik and Ken Hardy and Kieran Phelan and Priya Danawate**

(45) Registration Date: **17 April 2012**

(30) Convention priority data:

(31) Number	(32) Date	(33) Country
29/401391	12 Sep 2011	UNITED STATES OF AMERICA

(56) Related Art Documents: **Not Applicable**

(57) Statement of Newness and Distinctiveness: **Newness and distinctiveness reside in the pattern and/or ornamentation of a display screen with icon as illustrated by solid lines in the accompanying representations. The features shown in broken outline are for illustrative purposes only and do not form part of the design.**

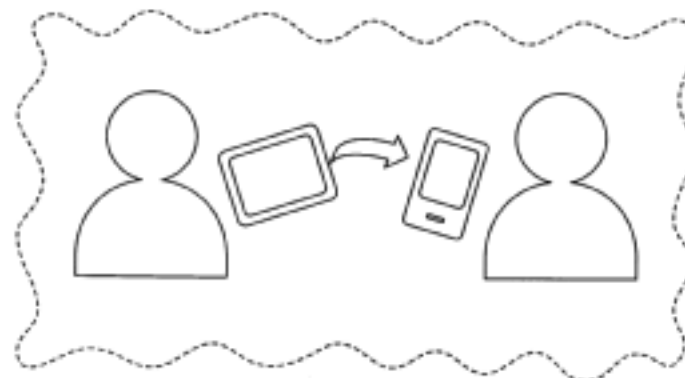

(21) Design Number: **11217/2012**
(22) Date of Filing Application: **07 March 2012**
(24) Date from which industrial property rights may have effect: **07 March 2012**
(54) Product in respect of which the design is registered: **Display screen with user interface**
(51) International Design Classification: **14-04**
(74) Name(s) of Attorney(s): **Shelston IP**
(71) Name(s) and Address(s) of Applicant(s):

Microsoft Corporation
One Microsoft Way Redmond Washington 98052 United States of America

(72) Name(s) of Designer(s): **David Earl Washington and Kristie Eileen Smith and Peter Seraphim Ponomarev and Ilana Rae Smith and Kieran Phelan**

(45) Registration Date: **17 April 2012**

(30) Convention priority data:

(31) Number	(32) Date	(33) Country
29/401549	12 Sep 2011	UNITED STATES OF AMERICA

(56) Related Art Documents: **Not Applicable**

(57) Statement of Newness and Distinctiveness: **Newness and distinctiveness reside in the pattern and/or ornamentation of a display screen with user interface as illustrated by solid lines in the accompanying representations. The features shown in broken outline are for illustrative purposes only and do not form part of the design.**

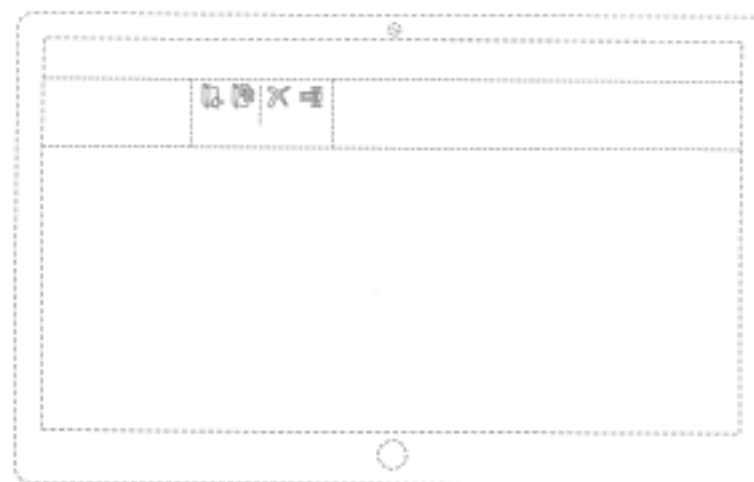

- (21) Design Number: **11218/2012**
(22) Date of Filing Application: **07 March 2012**
(24) Date from which industrial property rights may have effect: **07 March 2012**
(54) Product in respect of which the design is registered: **Display screen with user interface**
(51) International Design Classification: **14-04**
(74) Name(s) of Attorney(s): **Shelston IP**
(71) Name(s) and Address(s) of Applicant(s):
Microsoft Corporation
One Microsoft Way Redmond Washington 98052 United States of America
(72) Name(s) of Designer(s): **Zachary J. Shallcross and Michael John Patten and Lindsey R. Barcheck and Mary-Lynne Williams and Mirko Mandic and Ian Hyun Sun Kim and Roger William Benson and Marty J. Hall**
(45) Registration Date: **17 April 2012**
(30) Convention priority data:
(31) Number (32) Date (33) Country
29/401469 12 Sep 2011 UNITED STATES OF AMERICA
(56) Related Art Documents: **Not Applicable**
(57) Statement of Newness and Distinctiveness: **Newness and distinctiveness reside in the pattern and/or ornamentation of a display screen with user interface as illustrated by solid lines in the accompanying representations. The features shown in broken outline are for illustrative purposes only and do not form part of the design.**

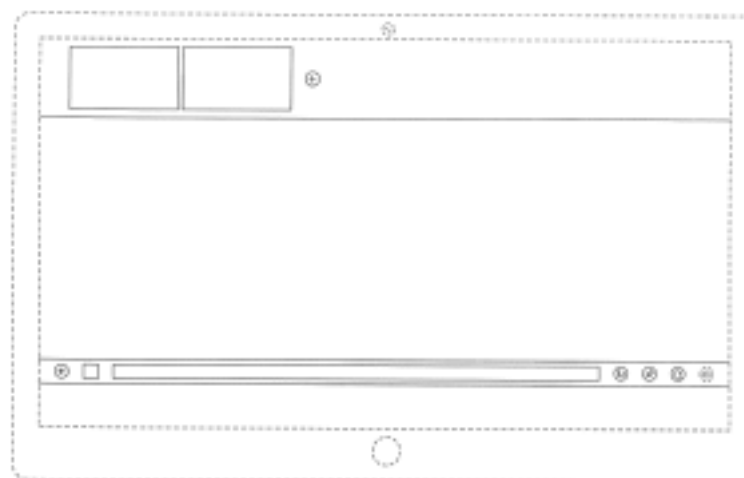

- (21) Design Number: **11219/2012**
(22) Date of Filing Application: **07 March 2012**
(24) Date from which industrial property rights may have effect: **07 March 2012**
(54) Product in respect of which the design is registered: **Display screen with user interface**
(51) International Design Classification: **14-04**
(74) Name(s) of Attorney(s): **Shelston IP**
(71) Name(s) and Address(s) of Applicant(s):
Microsoft Corporation
One Microsoft Way Redmond Washington 98052 United States of America
(72) Name(s) of Designer(s): **Daryl Tanghe and Daniel Oliver**
(45) Registration Date: **17 April 2012**
(30) Convention priority data:
(31) Number (32) Date (33) Country
29/401525 12 Sep 2011 UNITED STATES OF AMERICA
(56) Related Art Documents: **Not Applicable**
(57) Statement of Newness and Distinctiveness: **Newness and distinctiveness reside in the pattern and/or ornamentation of a display screen with user interface as illustrated by solid lines in the accompanying representations. The features shown in broken outline are for illustrative purposes only and do not form part of the design.**

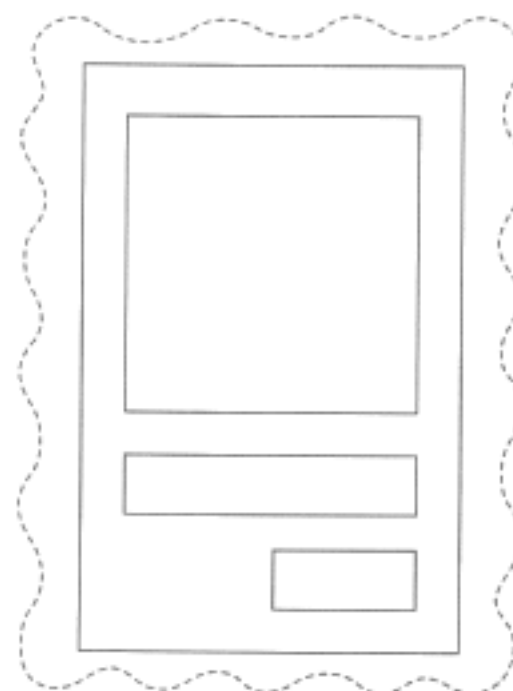

(21) Design Number: **11220/2012**
(22) Date of Filing Application: **07 March 2012**
(24) Date from which industrial property rights may have effect: **07 March 2012**
(54) Product in respect of which the design is registered: **Display screen with user interface**
(51) International Design Classification: **14-04**
(74) Name(s) of Attorney(s): **Shelston IP**
(71) Name(s) and Address(s) of Applicant(s):
Microsoft Corporation
One Microsoft Way Redmond Washington 98052 United States of America
(72) Name(s) of Designer(s): **Daryl Tanghe and Daniel Oliver**
(45) Registration Date: **17 April 2012**
(30) Convention priority data:
(31) Number (32) Date (33) Country
29/401526 12 Sep 2011 UNITED STATES OF AMERICA
(56) Related Art Documents: **Not Applicable**
(57) Statement of Newness and Distinctiveness: **Newness and distinctiveness reside in the pattern and/or ornamentation of a display screen with user interface as illustrated by solid lines in the accompanying representations. The features shown in broken outline are for illustrative purposes only and do not form part of the design.**

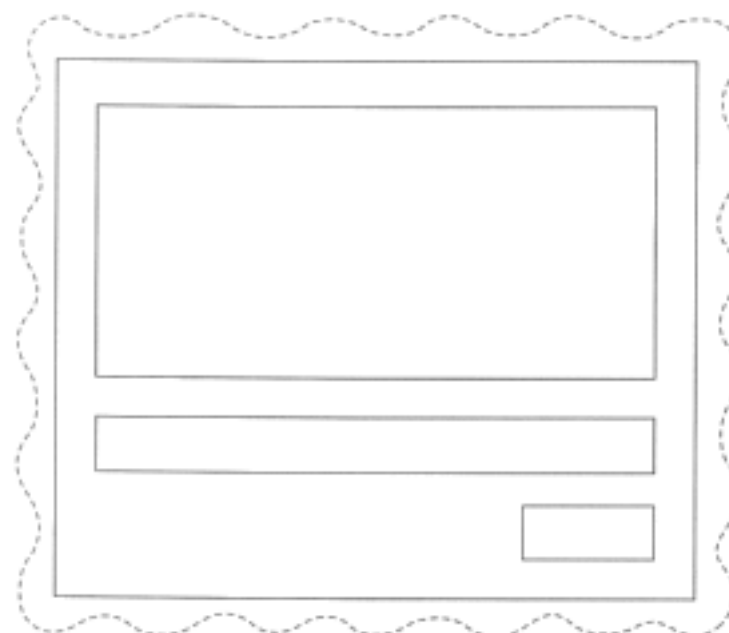

(21) Design Number: **11221/2012**
(22) Date of Filing Application: **07 March 2012**
(24) Date from which industrial property rights may have effect: **07 March 2012**
(54) Product in respect of which the design is registered: **Display screen with user interface**
(51) International Design Classification: **14-04**
(74) Name(s) of Attorney(s): **Shelston IP**
(71) Name(s) and Address(s) of Applicant(s):
Microsoft Corporation
One Microsoft Way Redmond Washington 98052 United States of America
(72) Name(s) of Designer(s): **Ann Marie Hudspeth and Leslie Christine MacNeal**
(45) Registration Date: **17 April 2012**
(30) Convention priority data:
(31) Number (32) Date (33) Country
29/401429 12 Sep 2011 UNITED STATES OF AMERICA
(56) Related Art Documents: **Not Applicable**
(57) Statement of Newness and Distinctiveness: **Newness and distinctiveness reside in the pattern and/or ornamentation of a display screen with user interface as illustrated by solid lines in the accompanying representations. The features shown in broken outline are for illustrative purposes only and do not form part of the design.**

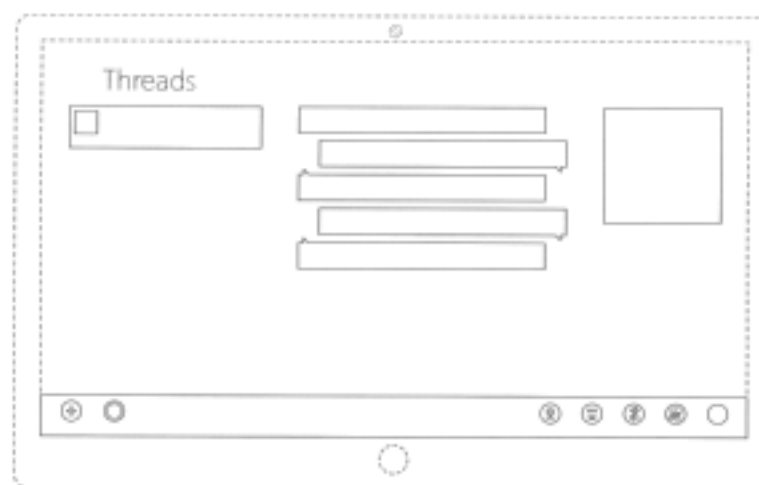

- (21) Design Number: **11365/2012**
(22) Date of Filing Application: **16 March 2012**
(24) Date from which industrial property rights may have effect: **16 March 2012**
(54) Product in respect of which the design is registered: **LED rear combination lamp**
(51) International Design Classification: **26-06**
(74) Name(s) of Attorney(s):
(71) Name(s) and Address(s) of Applicant(s):
Auto Electrical Imports Pty Ltd
C/- Nicholsons Solicitors GPO Box 454 Queensland 4001 Australia
(72) Name(s) of Designer(s): **Norman John Haupt**
(45) Registration Date: **17 April 2012**
(56) Related Art Documents: **Not Applicable**
(57) Statement of Newness and Distinctiveness: **The LED Rear Combination Lamp is new and distinctive as it has been designed to incorporate indicator, stop, tail and reverse light functions with a operating voltage of 10-30VDC. It has polycarbonate lens material providing high levels of impact resistance and is sealed against moisture and dust ingress. The new and distinctive visual features of the extrusion are: slimline and low profile design; single piece design with all mounting, lens, physical and environmental protection functions being incorporated in the one unit; no additional Gaskets, seals, mounting brackets or bezels required; mounting points (x2) accessed from front of lamp body.**



- (21) Design Number: **11414/2012**
(22) Date of Filing Application: **20 March 2012**
(24) Date from which industrial property rights may have effect: **20 March 2012**
(54) Product in respect of which the design is registered: **Extrusion**
(51) International Design Classification: **25-01K**
(74) Name(s) of Attorney(s):
(71) Name(s) and Address(s) of Applicant(s):
Aluminium Industries of Australia Pty Ltd
160 Ordish Road Dandenong South Victoria 3175 Australia
(72) Name(s) of Designer(s): **Matthew Keen and Tracey Coad**
(45) Registration Date: **17 April 2012**
(56) Related Art Documents: **Not Applicable**
(57) Statement of Newness and Distinctiveness: **Monopoly is claimed in the shape and/or configuration of the extruded H Extrusion as illustrated in the representations and which is of indefinite length. Particularly, monopoly is claimed in the shape and/or configuration of the four corner channel recesses and two central screw flutes.**

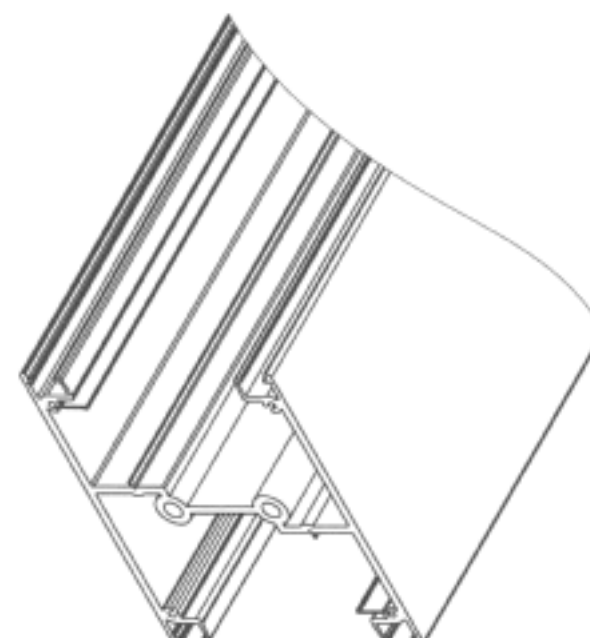

- (21) Design Number: **11415/2012**
(22) Date of Filing Application: **20 March 2012**
(24) Date from which industrial property rights may have effect: **20 March 2012**
(54) Product in respect of which the design is registered: **Extrusion**
(51) International Design Classification: **25-01K**
(74) Name(s) of Attorney(s):
(71) Name(s) and Address(s) of Applicant(s):
Aluminium Industries of Australia Pty Ltd
160 Ordish Road Dandenong South Victoria 3175 Australia
(72) Name(s) of Designer(s): **Matthew Keen and Tracey Coad**
(45) Registration Date: **17 April 2012**
(56) Related Art Documents: **Not Applicable**
(57) Statement of Newness and Distinctiveness: **Monopoly is claimed in the shape and/or configuration of the extruded Cover Plate Extrusion as illustrated in the representations and which is of indefinite length. Particularly, monopoly is claimed in the shape/or configuration of the hook in area of the plate.**



- (21) Design Number: **11416/2012**
(22) Date of Filing Application: **20 March 2012**
(24) Date from which industrial property rights may have effect: **20 March 2012**
(54) Product in respect of which the design is registered: **Extrusion**
(51) International Design Classification: **25-01K**
(74) Name(s) of Attorney(s):
(71) Name(s) and Address(s) of Applicant(s):
Aluminium Industries of Australia Pty Ltd
160 Ordish Road Dandenong South Victoria 3175 Australia
(72) Name(s) of Designer(s): **Matthew Keen and Tracey Coad**
(45) Registration Date: **17 April 2012**
(56) Related Art Documents: **Not Applicable**
(57) Statement of Newness and Distinctiveness: **Monopoly is claimed in the shape and/or configuration of the extruded H Extrusion Assembly as illustrated in the representations and which is of indefinite length. Particularly, monopoly is claimed in the shape/or configuration of the hook in area of the plate and the four corner channel recesses in the H Extrusion.**

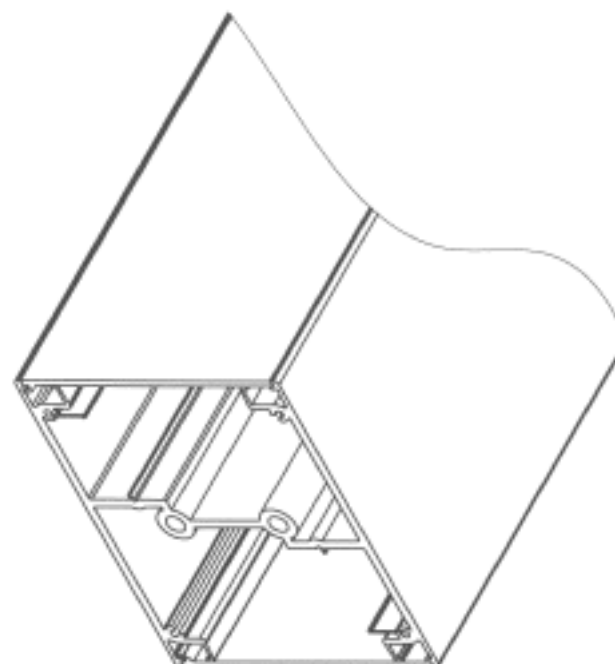

- (21) Design Number: **10337/2012**
(22) Date of Filing Application: **25 January 2012**
(24) Date from which industrial property rights may have effect: **25 January 2012**
(54) Product in respect of which the design is registered: **Pump unit**
(51) International Design Classification: **15-02**
(74) Name(s) of Attorney(s):
(71) Name(s) and Address(s) of Applicant(s):
Kenneth Herbert Henderson
70 Malak Crescent Malak Northern Territory 0812 Australia
(72) Name(s) of Designer(s): **Kenneth Herbert Henderson**
(45) Registration Date: **17 April 2012**
(56) Related Art Documents: **Not Applicable**
(57) Statement of Newness and Distinctiveness: **Twin tank pumping unit with swap-over valve (to be powder coated).**



- (21) Design Number: **10338/2012**
(22) Date of Filing Application: **25 January 2012**
(24) Date from which industrial property rights may have effect: **25 January 2012**
(54) Product in respect of which the design is registered: **Cleaning tray**
(51) International Design Classification: **07-05NES**
(74) Name(s) of Attorney(s):
(71) Name(s) and Address(s) of Applicant(s):
Kenneth Herbert Henderson
70 Malak Crescent Malak Northern Territory 0812 Australia
(72) Name(s) of Designer(s): **Kenneth Herbert Henderson**
(45) Registration Date: **17 April 2012**
(56) Related Art Documents: **Not Applicable**
(57) Statement of Newness and Distinctiveness: **Cleaning tray with extended plate for ease of inserting into hard to get areas with strap to attach to things.**



- (21) Design Number: **10578/2012**
(22) Date of Filing Application: **07 February 2012**
(24) Date from which industrial property rights may have effect: **07 February 2012**
(54) Product in respect of which the design is registered: **Food grater**
(51) International Design Classification: **07-04**
(74) Name(s) of Attorney(s): **Cullens Patent and Trade Mark Attorneys**
(71) Name(s) and Address(s) of Applicant(s):
QFF Holdings Pty Ltd
17-19 Wakefield Street Alderley Queensland 4051 Australia
(72) Name(s) of Designer(s): **Samuel Ross Himstedt and John Rafferty**
(45) Registration Date: **17 April 2012**
(56) Related Art Documents: **Not Applicable**
(57) Statement of Newness and Distinctiveness: **Newness and distinctiveness reside in the visual features of shape and configuration of a food grater as shown in the accompanying representations. When considering newness and distinctiveness, the features shown in the bottom view may be given little or no weight.**

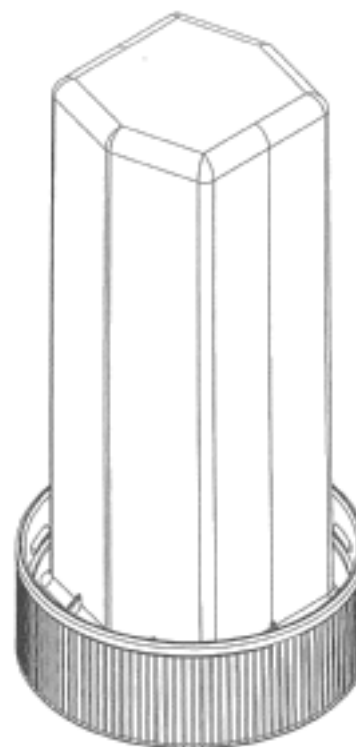

- (21) Design Number: **10579/2012**
(22) Date of Filing Application: **07 February 2012**
(24) Date from which industrial property rights may have effect: **07 February 2012**
(54) Product in respect of which the design is registered: **Food grater**
(51) International Design Classification: **07-04**
(74) Name(s) of Attorney(s): **Cullens Patent and Trade Mark Attorneys**
(71) Name(s) and Address(s) of Applicant(s):
QFF Holdings Pty Ltd
17-19 Wakefield Street Alderley Queensland 4051 Australia
(72) Name(s) of Designer(s): **Samuel Ross Himstedt and John Rafferty**
(45) Registration Date: **17 April 2012**
(56) Related Art Documents: **Not Applicable**
(57) Statement of Newness and Distinctiveness: **Newness and distinctiveness reside in the visual features of shape and configuration of a food grater as shown in the accompanying representations. When considering newness and distinctiveness, the features shown in the bottom view may be given little or no weight.**

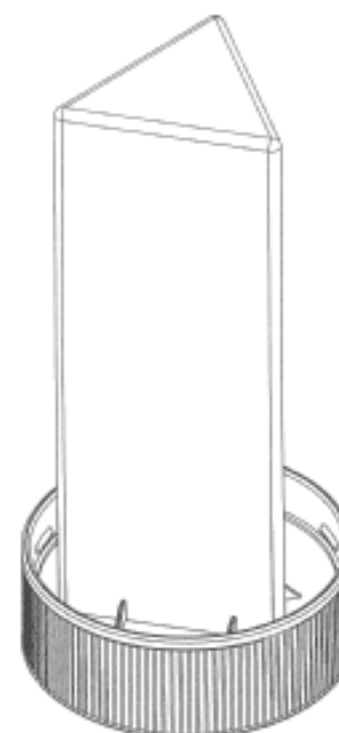

- (21) Design Number: **10580/2012**
(22) Date of Filing Application: **07 February 2012**
(24) Date from which industrial property rights may have effect: **07 February 2012**
(54) Product in respect of which the design is registered: **Food grater**
(51) International Design Classification: **07-04**
(74) Name(s) of Attorney(s): **Cullens Patent and Trade Mark Attorneys**
(71) Name(s) and Address(s) of Applicant(s):
QFF Holdings Pty Ltd
17-19 Wakefield Street Alderley Queensland 4051 Australia
(72) Name(s) of Designer(s): **Samuel Ross Himstedt and John Rafferty**
(45) Registration Date: **17 April 2012**
(56) Related Art Documents: **Not Applicable**
(57) Statement of Newness and Distinctiveness: **Newness and distinctiveness reside in the visual features of shape and configuration of a food grater as shown in the accompanying representations. When considering newness and distinctiveness, the features shown in the bottom view may be given little or no weight.**

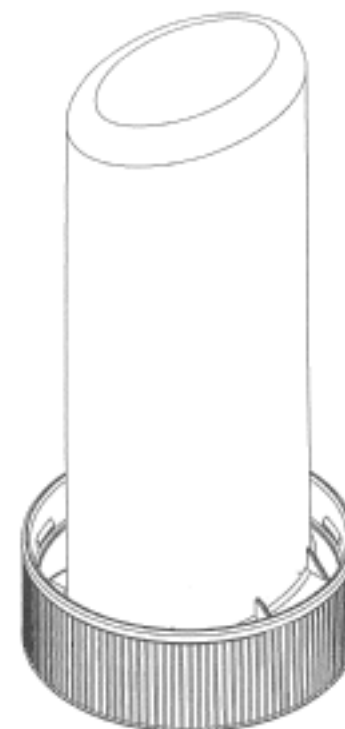

- (21) Design Number: **10581/2012**
(22) Date of Filing Application: **07 February 2012**
(24) Date from which industrial property rights may have effect: **07 February 2012**
(54) Product in respect of which the design is registered: **Food grater**
(51) International Design Classification: **07-04**
(74) Name(s) of Attorney(s): **Cullens Patent and Trade Mark Attorneys**
(71) Name(s) and Address(s) of Applicant(s):
QFF Holdings Pty Ltd
17-19 Wakefield Street Alderley Queensland 4051 Australia
(72) Name(s) of Designer(s): **Samuel Ross Himstedt and John Rafferty**
(45) Registration Date: **17 April 2012**
(56) Related Art Documents: **Not Applicable**
(57) Statement of Newness and Distinctiveness: **Newness and distinctiveness reside in the visual features of shape and configuration of a food grater as shown in the accompanying representations. When considering newness and distinctiveness, the features shown in the bottom view may be given little or no weight.**

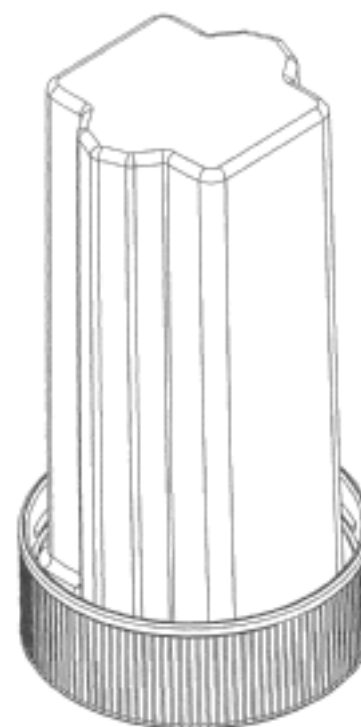

- (21) Design Number: **10582/2012**
(22) Date of Filing Application: **07 February 2012**
(24) Date from which industrial property rights may have effect: **07 February 2012**
(54) Product in respect of which the design is registered: **Food grater**
(51) International Design Classification: **07-04**
(74) Name(s) of Attorney(s): **Cullens Patent and Trade Mark Attorneys**
(71) Name(s) and Address(s) of Applicant(s):
QFF Holdings Pty Ltd
17-19 Wakefield Street Alderley Queensland 4051 Australia
(72) Name(s) of Designer(s): **Samuel Ross Himstedt and John Rafferty**
(45) Registration Date: **17 April 2012**
(56) Related Art Documents: **Not Applicable**
(57) Statement of Newness and Distinctiveness: **Newness and distinctiveness reside in the visual features of shape and configuration of a food grater as shown in the accompanying representations. When considering newness and distinctiveness, the features shown in the bottom view may be given little or no weight.**



- (21) Design Number: **11207/2012**
(22) Date of Filing Application: **07 March 2012**
(24) Date from which industrial property rights may have effect: **07 March 2012**
(54) Product in respect of which the design is registered: **Display screen with user interface**
(51) International Design Classification: **14-04**
(74) Name(s) of Attorney(s): **Shelston IP**
(71) Name(s) and Address(s) of Applicant(s):
Microsoft Corporation
One Microsoft Way Redmond Washington 98052 United States of America
(72) Name(s) of Designer(s): **William Yang and Janani Krishaswamy and Leslie Christine MacNeal**
(45) Registration Date: **17 April 2012**
(30) Convention priority data:
(31) Number (32) Date (33) Country
29/401443 12 Sep 2011 UNITED STATES OF AMERICA
(56) Related Art Documents: **Not Applicable**
(57) Statement of Newness and Distinctiveness: **Newness and distinctiveness reside in the pattern and/or ornamentation of a display screen with user interface as illustrated by solid lines in the accompanying representations. The features shown in broken outline are for illustrative purposes only and do not form part of the design.**

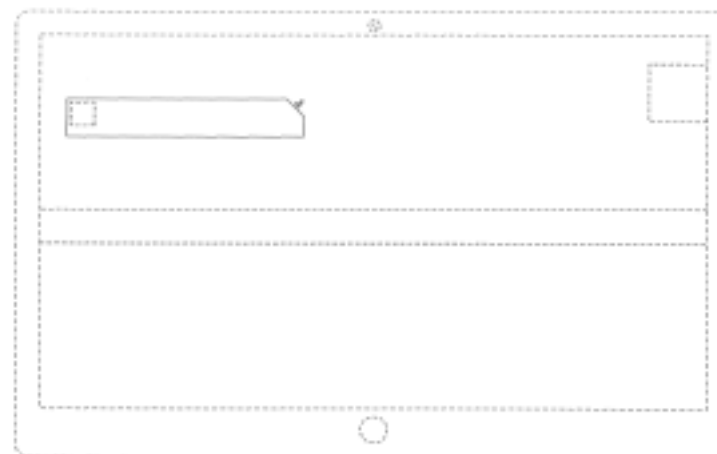

(21) Design Number: **11208/2012**
(22) Date of Filing Application: **07 March 2012**
(24) Date from which industrial property rights may have effect: **07 March 2012**
(54) Product in respect of which the design is registered: **Display screen with icon group**
(51) International Design Classification: **14-04**
(74) Name(s) of Attorney(s): **Shelston IP**
(71) Name(s) and Address(s) of Applicant(s):
Microsoft Corporation
One Microsoft Way Redmond Washington 98052 United States of America
(72) Name(s) of Designer(s): **Kieran Phelan and Leslie Christine MacNeal**
(45) Registration Date: **17 April 2012**
(30) Convention priority data:
(31) Number (32) Date (33) Country
29/401560 12 Sep 2011 UNITED STATES OF AMERICA
(56) Related Art Documents: **Not Applicable**
(57) Statement of Newness and Distinctiveness: **Newness and distinctiveness reside in the pattern and/or ornamentation of a display screen with icon group as illustrated by solid lines in the accompanying representations. The features shown in broken outline are for illustrative purposes only and do not form part of the design.**

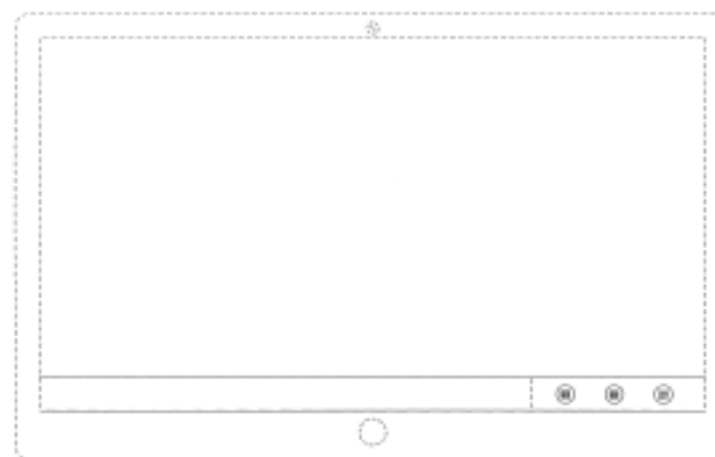

(21) Design Number: **11209/2012**
(22) Date of Filing Application: **07 March 2012**
(24) Date from which industrial property rights may have effect: **07 March 2012**
(54) Product in respect of which the design is registered: **Display screen with user interface**
(51) International Design Classification: **14-04**
(74) Name(s) of Attorney(s): **Shelston IP**
(71) Name(s) and Address(s) of Applicant(s):
Microsoft Corporation
One Microsoft Way Redmond Washington 98052 United States of America
(72) Name(s) of Designer(s): **William Yang and Keith Fournier and Leslie Christine MacNeal**
(45) Registration Date: **17 April 2012**
(30) Convention priority data:
(31) Number (32) Date (33) Country
29/401460 12 Sep 2011 UNITED STATES OF AMERICA
(56) Related Art Documents: **Not Applicable**
(57) Statement of Newness and Distinctiveness: **Newness and distinctiveness reside in the pattern and/or ornamentation of a display screen with user interface as illustrated by solid lines in the accompanying representations. The features shown in broken outline are for illustrative purposes only and do not form part of the design.**

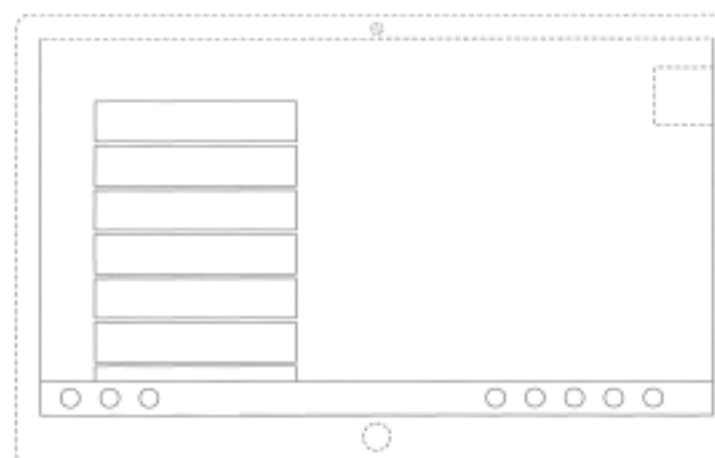

- (21) Design Number: **11210/2012**
(22) Date of Filing Application: **07 March 2012**
(24) Date from which industrial property rights may have effect: **07 March 2012**
(54) Product in respect of which the design is registered: **Display screen with user interface**
(51) International Design Classification: **14-04**
(74) Name(s) of Attorney(s): **Shelston IP**
(71) Name(s) and Address(s) of Applicant(s):
Microsoft Corporation
One Microsoft Way Redmond Washington 98052 United States of America
(72) Name(s) of Designer(s): **Daryl Tanghe and Ethan Nelson Ray and Nazia Zaman and Rebecca Deutsch and Michael Gilmore and Brian Uphoff and Priya Vaidyanthan**
(45) Registration Date: **17 April 2012**
(30) Convention priority data:
(31) Number (32) Date (33) Country
29/401510 12 Sep 2011 UNITED STATES OF AMERICA
(56) Related Art Documents: **Not Applicable**
(57) Statement of Newness and Distinctiveness: **Newness and distinctiveness reside in the pattern and/or ornamentation of a display screen with user interface as illustrated by solid lines in the accompanying representations. The features shown in broken outline are for illustrative purposes only and do not form part of the design.**

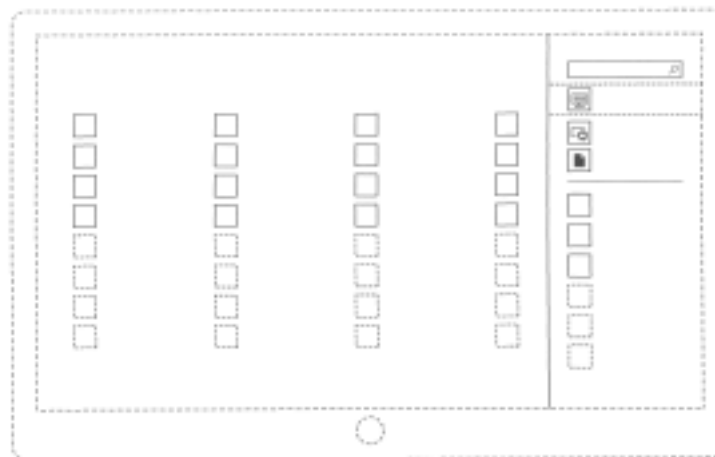

- (21) Design Number: **11471/2012**
(22) Date of Filing Application: **21 March 2012**
(24) Date from which industrial property rights may have effect: **21 March 2012**
(54) Product in respect of which the design is registered: **Vehicular LED lighting fixture**
(51) International Design Classification: **26-06**
(74) Name(s) of Attorney(s): **PIZZEYS**
(71) Name(s) and Address(s) of Applicant(s):
Stephen Adams
4641 E. Ivy Mesa AZ 85215 United States of America
(72) Name(s) of Designer(s): **Stephen Adams**
(45) Registration Date: **17 April 2012**
(30) Convention priority data:
(31) Number (32) Date (33) Country
29/402185 21 Sep 2011 UNITED STATES OF AMERICA
(56) Related Art Documents: **Not Applicable**
(57) Statement of Newness and Distinctiveness: **The newness and distinctiveness of the design resides in the features of pattern and/or ornamentations OR shape and/or configuration shown in unbroken lines in the accompanying representations. (if required, see Convention document)**

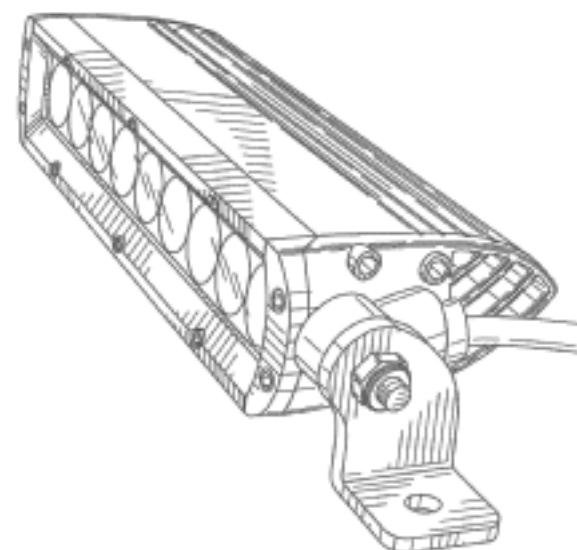

(21) Design Number: **11237/2012**
(22) Date of Filing Application: **07 March 2012**
(24) Date from which industrial property rights may have effect: **07 March 2012**
(54) Product in respect of which the design is registered: **Display screen with icon**
(51) International Design Classification: **14-04**
(74) Name(s) of Attorney(s): **Shelston IP**
(71) Name(s) and Address(s) of Applicant(s):

Microsoft Corporation
One Microsoft Way Redmond Washington 98052 United States of America

(72) Name(s) of Designer(s): **Kieran Phelan**

(45) Registration Date: **17 April 2012**

(30) Convention priority data:

(31) Number	(32) Date	(33) Country
29/401536	12 Sep 2011	UNITED STATES OF AMERICA

(56) Related Art Documents: **Not Applicable**

(57) Statement of Newness and Distinctiveness: **Newness and distinctiveness reside in the pattern and/or ornamentation of a display screen with icon as illustrated by solid lines in the accompanying representations. The features shown in broken outline are for illustrative purposes only and do not form part of the design.**



(21) Design Number: **11238/2012**
(22) Date of Filing Application: **07 March 2012**
(24) Date from which industrial property rights may have effect: **07 March 2012**
(54) Product in respect of which the design is registered: **Display screen with user interface**
(51) International Design Classification: **14-04**
(74) Name(s) of Attorney(s): **Shelston IP**
(71) Name(s) and Address(s) of Applicant(s):

Microsoft Corporation
One Microsoft Way Redmond Washington 98052 United States of America

(72) Name(s) of Designer(s): **Ann Marie Hudspeth and Alena Louise Benson**

(45) Registration Date: **17 April 2012**

(30) Convention priority data:

(31) Number	(32) Date	(33) Country
29/401444	12 Sep 2011	UNITED STATES OF AMERICA

(56) Related Art Documents: **Not Applicable**

(57) Statement of Newness and Distinctiveness: **Newness and distinctiveness reside in the pattern and/or ornamentation of a display screen with user interface as illustrated by solid lines in the accompanying representations. The features shown in broken outline are for illustrative purposes only and do not form part of the design.**

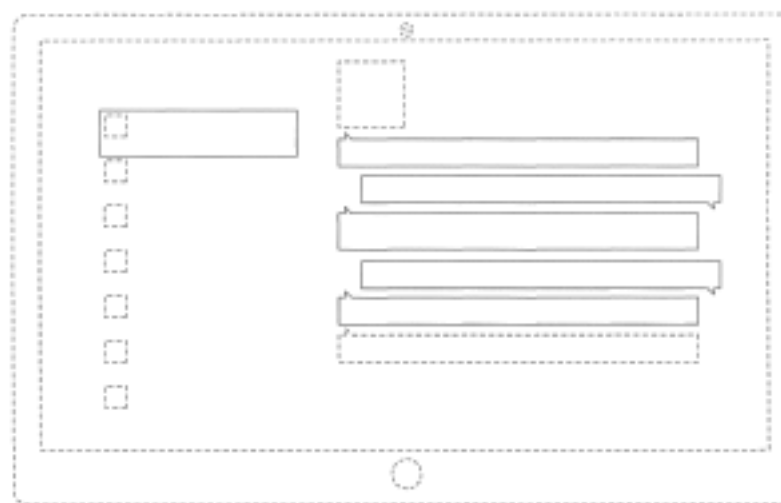

(21) Design Number: **11239/2012**
(22) Date of Filing Application: **07 March 2012**
(24) Date from which industrial property rights may have effect: **07 March 2012**
(54) Product in respect of which the design is registered: **Display screen with icon**
(51) International Design Classification: **14-04**
(74) Name(s) of Attorney(s): **Shelston IP**
(71) Name(s) and Address(s) of Applicant(s):
Microsoft Corporation
One Microsoft Way Redmond Washington 98052 United States of America
(72) Name(s) of Designer(s): **Kieran Phelan**
(45) Registration Date: **17 April 2012**
(30) Convention priority data:
(31) Number (32) Date (33) Country
29/401373 12 Sep 2011 UNITED STATES OF AMERICA
(56) Related Art Documents: **Not Applicable**
(57) Statement of Newness and Distinctiveness: **Newness and distinctiveness reside in the pattern and/or ornamentation of a display screen with icon as illustrated by solid lines in the accompanying representations. The features shown in broken outline are for illustrative purposes only and do not form part of the design.**



(21) Design Number: **11240/2012**
(22) Date of Filing Application: **07 March 2012**
(24) Date from which industrial property rights may have effect: **07 March 2012**
(54) Product in respect of which the design is registered: **Display screen with icon**
(51) International Design Classification: **14-04**
(74) Name(s) of Attorney(s): **Shelston IP**
(71) Name(s) and Address(s) of Applicant(s):
Microsoft Corporation
One Microsoft Way Redmond Washington 98052 United States of America
(72) Name(s) of Designer(s): **Kieran Phelan and Travis Eby and Sangeeta Rangit**
(45) Registration Date: **17 April 2012**
(30) Convention priority data:
(31) Number (32) Date (33) Country
29/401413 12 Sep 2011 UNITED STATES OF AMERICA
(56) Related Art Documents: **Not Applicable**
(57) Statement of Newness and Distinctiveness: **Newness and distinctiveness reside in the pattern and/or ornamentation of a display screen with icon as illustrated by solid lines in the accompanying representations. The features shown in broken outline are for illustrative purposes only and do not form part of the design.**

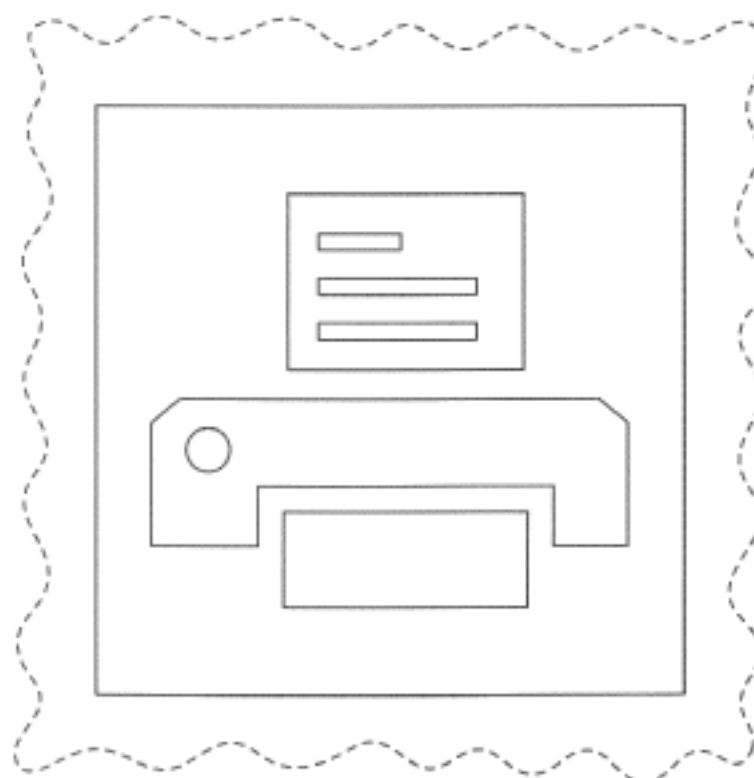

(21) Design Number: **11241/2012**
(22) Date of Filing Application: **07 March 2012**
(24) Date from which industrial property rights may have effect: **07 March 2012**
(54) Product in respect of which the design is registered: **Display screen with user interface**
(51) International Design Classification: **14-04**
(74) Name(s) of Attorney(s): **Shelston IP**
(71) Name(s) and Address(s) of Applicant(s):
Microsoft Corporation
One Microsoft Way Redmond Washington 98052 United States of America
(72) Name(s) of Designer(s): **Ann Marie Hudspeth and Alena Louise Benson**
(45) Registration Date: **17 April 2012**
(30) Convention priority data:
(31) Number (32) Date (33) Country
29/401446 12 Sep 2011 UNITED STATES OF AMERICA
(56) Related Art Documents: **Not Applicable**
(57) Statement of Newness and Distinctiveness: **Newness and distinctiveness reside in the pattern and/or ornamentation of a display screen with user interface as illustrated by solid lines in the accompanying representations. The features shown in broken outline are for illustrative purposes only and do not form part of the design.**

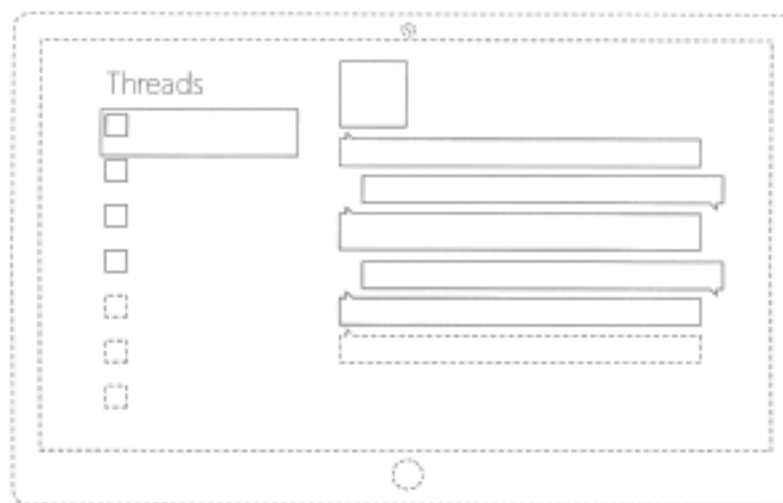

(21) Design Number: **11242/2012**
(22) Date of Filing Application: **07 March 2012**
(24) Date from which industrial property rights may have effect: **07 March 2012**
(54) Product in respect of which the design is registered: **Display screen with icon**
(51) International Design Classification: **14-04**
(74) Name(s) of Attorney(s): **Shelston IP**
(71) Name(s) and Address(s) of Applicant(s):
Microsoft Corporation
One Microsoft Way Redmond Washington 98052 United States of America
(72) Name(s) of Designer(s): **Kieran Phelan**
(45) Registration Date: **17 April 2012**
(30) Convention priority data:
(31) Number (32) Date (33) Country
29/401478 12 Sep 2011 UNITED STATES OF AMERICA
(56) Related Art Documents: **Not Applicable**
(57) Statement of Newness and Distinctiveness: **Newness and distinctiveness reside in the pattern and/or ornamentation of a display screen with icon as illustrated by solid lines in the accompanying representations. The features shown in broken outline are for illustrative purposes only and do not form part of the design.**

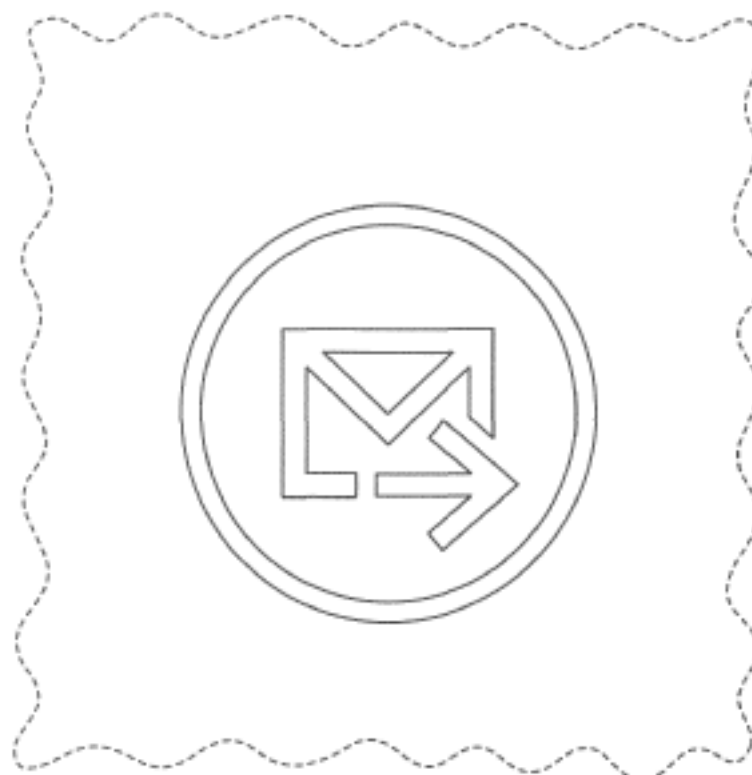

(21) Design Number: **11243/2012**
(22) Date of Filing Application: **07 March 2012**
(24) Date from which industrial property rights may have effect: **07 March 2012**
(54) Product in respect of which the design is registered: **Display screen with icon**
(51) International Design Classification: **14-04**
(74) Name(s) of Attorney(s): **Shelston IP**
(71) Name(s) and Address(s) of Applicant(s):

Microsoft Corporation
One Microsoft Way Redmond Washington 98052 United States of America

(72) Name(s) of Designer(s): **Kieran Phelan**

(45) Registration Date: **17 April 2012**

(30) Convention priority data:

(31) Number	(32) Date	(33) Country
29/401447	12 Sep 2011	UNITED STATES OF AMERICA

(56) Related Art Documents: **Not Applicable**

(57) Statement of Newness and Distinctiveness: **Newness and distinctiveness reside in the pattern and/or ornamentation of a display screen with icon as illustrated by solid lines in the accompanying representations. The features shown in broken outline are for illustrative purposes only and do not form part of the design.**

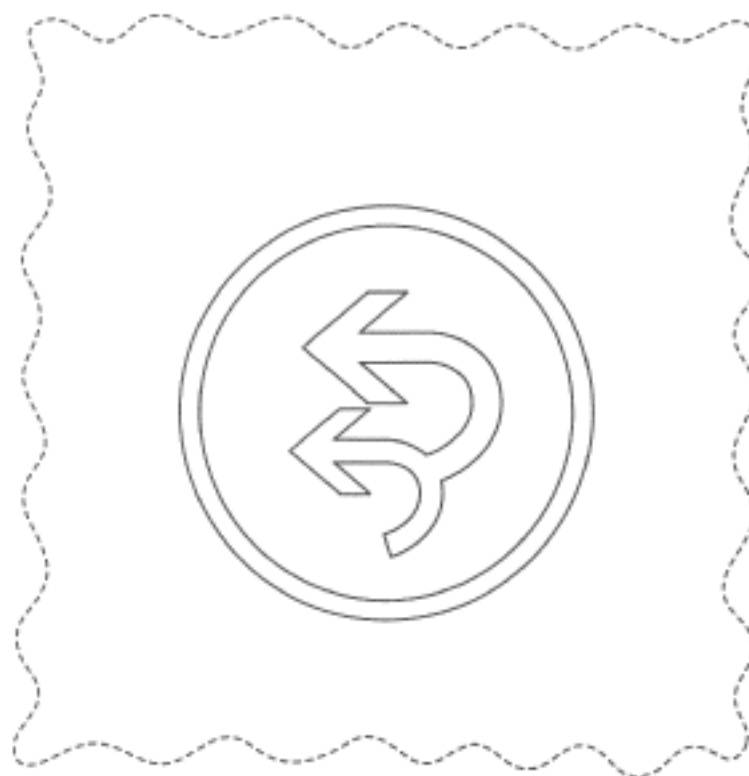

(21) Design Number: **11244/2012**
(22) Date of Filing Application: **07 March 2012**
(24) Date from which industrial property rights may have effect: **07 March 2012**
(54) Product in respect of which the design is registered: **Display screen with icon**
(51) International Design Classification: **14-04**
(74) Name(s) of Attorney(s): **Shelston IP**
(71) Name(s) and Address(s) of Applicant(s):

Microsoft Corporation
One Microsoft Way Redmond Washington 98052 United States of America

(72) Name(s) of Designer(s): **Kieran Phelan and Travis Eby and Jessica Murray and Michael H. LaManna and Catherine White**

(45) Registration Date: **17 April 2012**

(30) Convention priority data:

(31) Number	(32) Date	(33) Country
29/401408	12 Sep 2011	UNITED STATES OF AMERICA

(56) Related Art Documents: **Not Applicable**

(57) Statement of Newness and Distinctiveness: **Newness and distinctiveness reside in the pattern and/or ornamentation of a display screen with icon as illustrated by solid lines in the accompanying representations. The features shown in broken outline are for illustrative purposes only and do not form part of the design.**

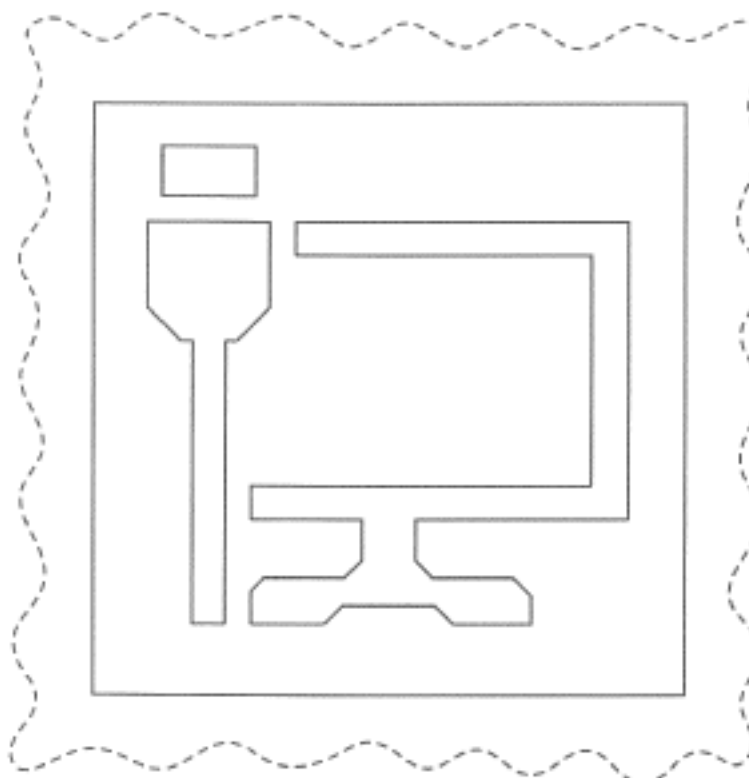

(21) Design Number: **11245/2012**
(22) Date of Filing Application: **07 March 2012**
(24) Date from which industrial property rights may have effect: **07 March 2012**
(54) Product in respect of which the design is registered: **Display screen with icon**
(51) International Design Classification: **14-04**
(74) Name(s) of Attorney(s): **Shelston IP**
(71) Name(s) and Address(s) of Applicant(s):

Microsoft Corporation
One Microsoft Way Redmond Washington 98052 United States of America

(72) Name(s) of Designer(s): **Kieran Phelan and Travis Eby and Jason Roberts**
(45) Registration Date: **17 April 2012**

(30) Convention priority data:

(31) Number	(32) Date	(33) Country
29/401410	12 Sep 2011	UNITED STATES OF AMERICA

(56) Related Art Documents: **Not Applicable**

(57) Statement of Newness and Distinctiveness: **Newness and distinctiveness reside in the pattern and/or ornamentation of a display screen with icon as illustrated by solid lines in the accompanying representations. The features shown in broken outline are for illustrative purposes only and do not form part of the design.**



(21) Design Number: **11246/2012**
(22) Date of Filing Application: **07 March 2012**
(24) Date from which industrial property rights may have effect: **07 March 2012**
(54) Product in respect of which the design is registered: **Display screen with icon**
(51) International Design Classification: **14-04**
(74) Name(s) of Attorney(s): **Shelston IP**
(71) Name(s) and Address(s) of Applicant(s):

Microsoft Corporation
One Microsoft Way Redmond Washington 98052 United States of America

(72) Name(s) of Designer(s): **Kieran Phelan**

(45) Registration Date: **17 April 2012**

(30) Convention priority data:

(31) Number	(32) Date	(33) Country
29/401374	12 Sep 2011	UNITED STATES OF AMERICA

(56) Related Art Documents: **Not Applicable**

(57) Statement of Newness and Distinctiveness: **Newness and distinctiveness reside in the pattern and/or ornamentation of a display screen with icon as illustrated by solid lines in the accompanying representations. The features shown in broken outline are for illustrative purposes only and do not form part of the design.**

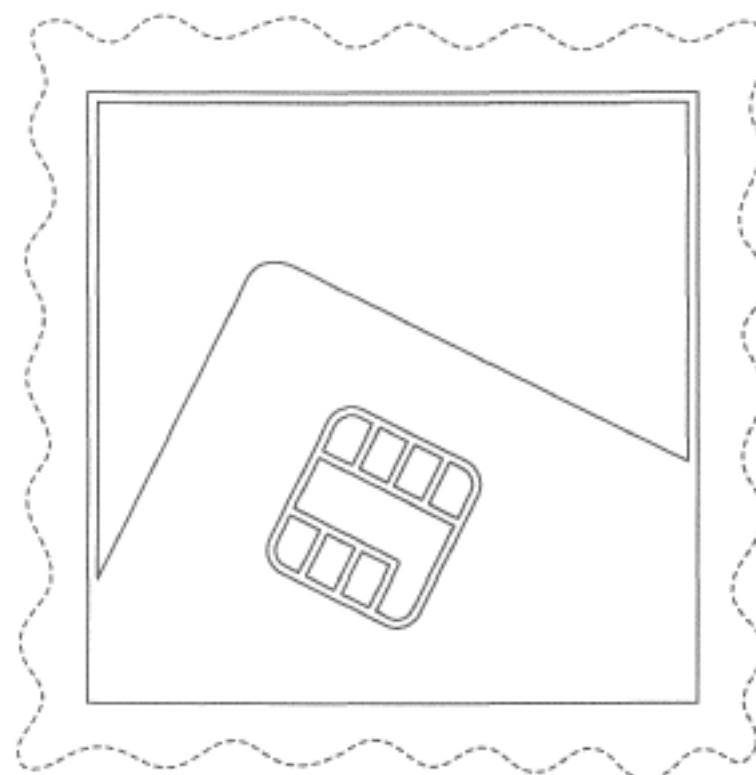

(21) Design Number: **11247/2012**
(22) Date of Filing Application: **07 March 2012**
(24) Date from which industrial property rights may have effect: **07 March 2012**
(54) Product in respect of which the design is registered: **Display screen with icon**
(51) International Design Classification: **14-04**
(74) Name(s) of Attorney(s): **Shelston IP**
(71) Name(s) and Address(s) of Applicant(s):

Microsoft Corporation
One Microsoft Way Redmond Washington 98052 United States of America

(72) Name(s) of Designer(s): **Kieran Phelan**

(45) Registration Date: **17 April 2012**

(30) Convention priority data:

(31) Number	(32) Date	(33) Country
29/401375	12 Sep 2011	UNITED STATES OF AMERICA

(56) Related Art Documents: **Not Applicable**

(57) Statement of Newness and Distinctiveness: **Newness and distinctiveness reside in the pattern and/or ornamentation of a display screen with icon as illustrated by solid lines in the accompanying representations. The features shown in broken outline are for illustrative purposes only and do not form part of the design.**

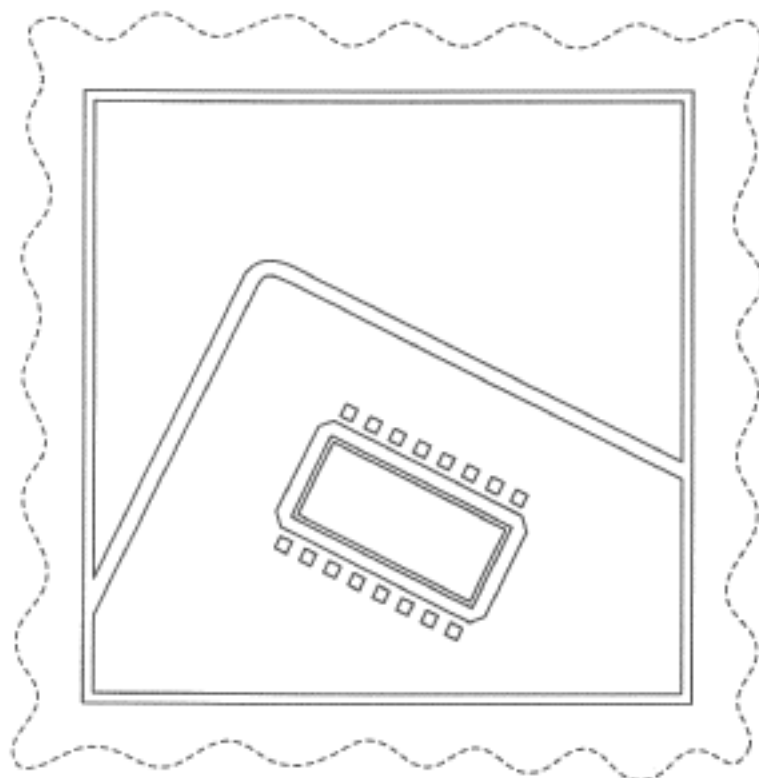

(21) Design Number: **11248/2012**
(22) Date of Filing Application: **07 March 2012**
(24) Date from which industrial property rights may have effect: **07 March 2012**
(54) Product in respect of which the design is registered: **Display screen with icon**
(51) International Design Classification: **14-04**
(74) Name(s) of Attorney(s): **Shelston IP**
(71) Name(s) and Address(s) of Applicant(s):

Microsoft Corporation
One Microsoft Way Redmond Washington 98052 United States of America

(72) Name(s) of Designer(s): **Kieran Phelan**

(45) Registration Date: **17 April 2012**

(30) Convention priority data:

(31) Number	(32) Date	(33) Country
29/401380	12 Sep 2011	UNITED STATES OF AMERICA

(56) Related Art Documents: **Not Applicable**

(57) Statement of Newness and Distinctiveness: **Newness and distinctiveness reside in the pattern and/or ornamentation of a display screen with icon as illustrated by solid lines in the accompanying representations. The features shown in broken outline are for illustrative purposes only and do not form part of the design.**



- (21) Design Number: **10505/2012**
(22) Date of Filing Application: **01 February 2012**
(24) Date from which industrial property rights may have effect: **01 February 2012**
(54) Product in respect of which the design is registered: **Panel for a container**
(51) International Design Classification: **09-01NES**
(74) Name(s) of Attorney(s): **WATERMARK PATENT AND TRADE MARKS ATTORNEYS**
(71) Name(s) and Address(s) of Applicant(s):
Constar International Inc
One Crown Way Philadelphia PA 19154 United States of America
(72) Name(s) of Designer(s): **Monis Bangi**
(45) Registration Date: **18 April 2012**
(30) Convention priority data:
(31) Number (32) Date (33) Country
29/398,722 03 Aug 2011 UNITED STATES OF AMERICA
(56) Related Art Documents: **Not Applicable**
(57) Statement of Newness and Distinctiveness: **The newness and distinctiveness of the design resides in the features of shape and configuration of a panel for a container as shown in the accompanying drawings; the structure shown in broken lines is for environment purposes and does not form part of the design.**



- (21) Design Number: **11754/2012**
(22) Date of Filing Application: **01 February 2012**
(24) Date from which industrial property rights may have effect: **01 February 2012**
(54) Product in respect of which the design is registered: **Panel for a container**
(51) International Design Classification: **09-01NES**
(74) Name(s) of Attorney(s): **WATERMARK PATENT AND TRADE MARKS ATTORNEYS**
(71) Name(s) and Address(s) of Applicant(s):
Constar International Inc
One Crown Way Philadelphia PA 19154 United States of America
(72) Name(s) of Designer(s): **Monis Bangi**
(45) Registration Date: **18 April 2012**
(30) Convention priority data:
(31) Number (32) Date (33) Country
29/398,722 03 Aug 2011 UNITED STATES OF AMERICA
(62) Divisional of: **341972**
(56) Related Art Documents: **Not Applicable**
(57) Statement of Newness and Distinctiveness: **The newness and distinctiveness of the design resides in the features of shape and configuration of a panel for a container as shown in the accompanying drawings; the structure shown in broken lines is for environment purposes and does not form part of the design.**

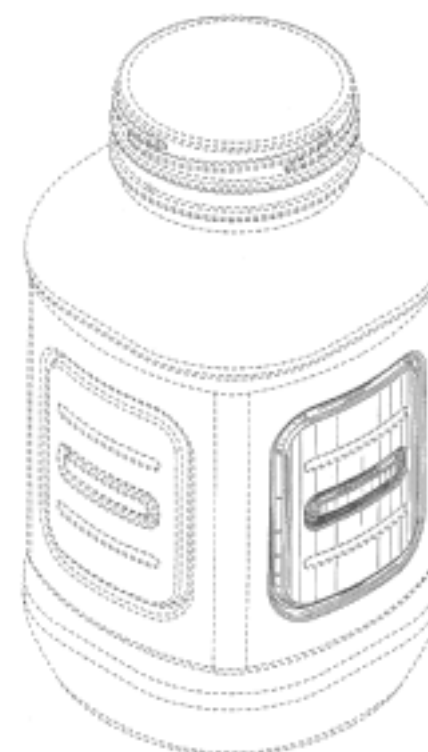

- (21) Design Number: **11755/2012**
(22) Date of Filing Application: **01 February 2012**
(24) Date from which industrial property rights may have effect: **01 February 2012**
(54) Product in respect of which the design is registered: **Panel for a container**
(51) International Design Classification: **09-01NES**
(74) Name(s) of Attorney(s): **WATERMARK PATENT AND TRADE MARKS ATTORNEYS**
(71) Name(s) and Address(s) of Applicant(s):
Constar International Inc
One Crown Way Philadelphia PA 19154 United States of America
(72) Name(s) of Designer(s): **Monis Bangi**
(45) Registration Date: **18 April 2012**
(30) Convention priority data:
(31) Number (32) Date (33) Country
29/398,722 03 Aug 2011 UNITED STATES OF AMERICA
(62) Divisional of: **341972**
(56) Related Art Documents: **Not Applicable**
(57) Statement of Newness and Distinctiveness: **The newness and distinctiveness of the design resides in the features of shape and configuration of a panel for a container as shown in the accompanying drawings; the structure shown in broken lines is for environment purposes and does not form part of the design.**



- (21) Design Number: **10627/2012**
(22) Date of Filing Application: **09 February 2012**
(24) Date from which industrial property rights may have effect: **09 February 2012**
(54) Product in respect of which the design is registered: **A cistern flushing button assembly**
(51) International Design Classification: **23-02C**
(74) Name(s) of Attorney(s): **SPRUSON & FERGUSON**
(71) Name(s) and Address(s) of Applicant(s):
Caroma Industries Limited
10 Market Street Brisbane Queensland 4000 Australia
(72) Name(s) of Designer(s): **Marc Andrew Newson**
(45) Registration Date: **18 April 2012**
(56) Related Art Documents: **Not Applicable**
(57) Statement of Newness and Distinctiveness: **Newness and distinctiveness is claimed in the features of shape and/or configuration of a cistern flushing button assembly as illustrated in solid lines in the accompanying representations.**

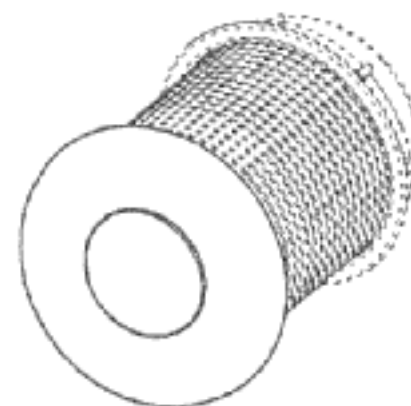

- (21) Design Number: **11719/2012**
(22) Date of Filing Application: **09 February 2012**
(24) Date from which industrial property rights may have effect: **09 February 2012**
(54) Product in respect of which the design is registered: **A cistern flushing button assembly**
(51) International Design Classification: **23-02C**
(74) Name(s) of Attorney(s): **SPRUSON & FERGUSON**
(71) Name(s) and Address(s) of Applicant(s):
Caroma Industries Limited
10 Market Street Brisbane Queensland 4000 Australia
(72) Name(s) of Designer(s): **Marc Andrew Newson**
(45) Registration Date: **18 April 2012**
(62) Divisional of: **341975**
(56) Related Art Documents: **Not Applicable**
(57) Statement of Newness and Distinctiveness: **Newness and distinctiveness is claimed in the features of shape and/or configuration of a cistern flushing button assembly as illustrated in solid lines in the accompanying representations.**

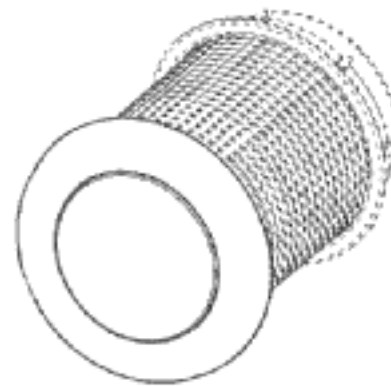

- (21) Design Number: **10787/2012**
(22) Date of Filing Application: **20 February 2012**
(24) Date from which industrial property rights may have effect: **20 February 2012**
(54) Product in respect of which the design is registered: **Cook book stand**
(51) International Design Classification: **06-04NES**
(74) Name(s) of Attorney(s): **Trademark Works**
(71) Name(s) and Address(s) of Applicant(s):
Joseph Joseph Ltd
The Grove 30 Great Guildford Street London SE1 9PH United Kingdom
(72) Name(s) of Designer(s): **Damian Evans and Bernard Sinclair**
(45) Registration Date: **18 April 2012**
(30) Convention priority data:
(31) Number (32) Date (33) Country
001962721-0001 14 Dec 2011 EUROPEAN COMMUNITY
(56) Related Art Documents: **Not Applicable**
(57) Statement of Newness and Distinctiveness: **Newness and distinctiveness is claimed in those features of shape and/or configuration of a cook book stand as illustrated in the accompanying illustrations.**

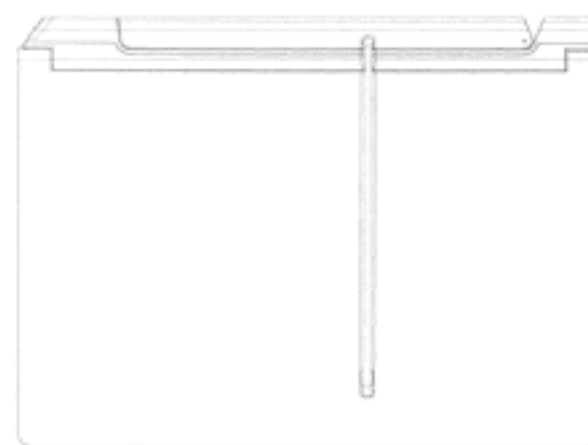

(21) Design Number: **11519/2012**
(22) Date of Filing Application: **26 March 2012**
(24) Date from which industrial property rights may have effect: **26 March 2012**
(54) Product in respect of which the design is registered: **LED driving light for use with or on vehicles**
(51) International Design Classification: **26-06**
(74) Name(s) of Attorney(s):
(71) Name(s) and Address(s) of Applicant(s):
ARB Corporation Ltd
42-44 Garden Street Kilsyth Victoria 3137 Australia
(72) Name(s) of Designer(s): **Joe Leban and Steve Adams**
(45) Registration Date: **18 April 2012**
(56) Related Art Documents: **Not Applicable**
(57) Statement of Newness and Distinctiveness: **Nil**

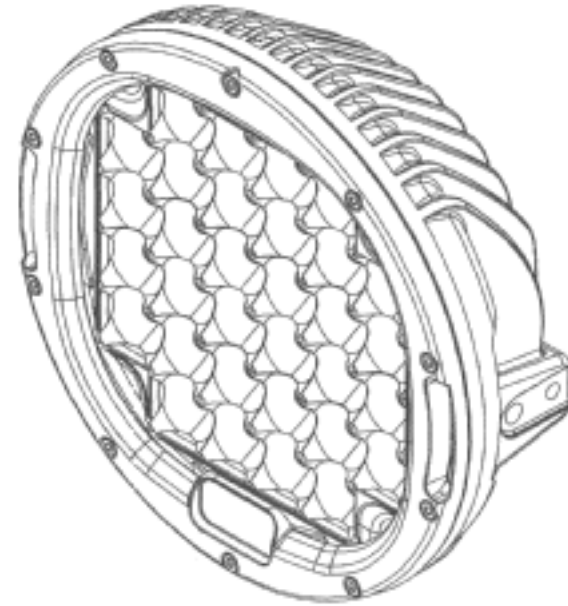

(21) Design Number: **10564/2012**
(22) Date of Filing Application: **06 February 2012**
(24) Date from which industrial property rights may have effect: **06 February 2012**
(54) Product in respect of which the design is registered: **Kitchen appliance**
(51) International Design Classification: **07-02NES**
(74) Name(s) of Attorney(s): **EKM patent & trade marks**
(71) Name(s) and Address(s) of Applicant(s):
Vendall Comercial 2003 S.L.
C/- Rita Bonnat 9 y 11 esq. Loreto 08029 Barcelona Spain
(72) Name(s) of Designer(s): **Jose M. Grife de Pascual**
(45) Registration Date: **18 April 2012**
(56) Related Art Documents: **Not Applicable**
(57) Statement of Newness and Distinctiveness: **Nil**

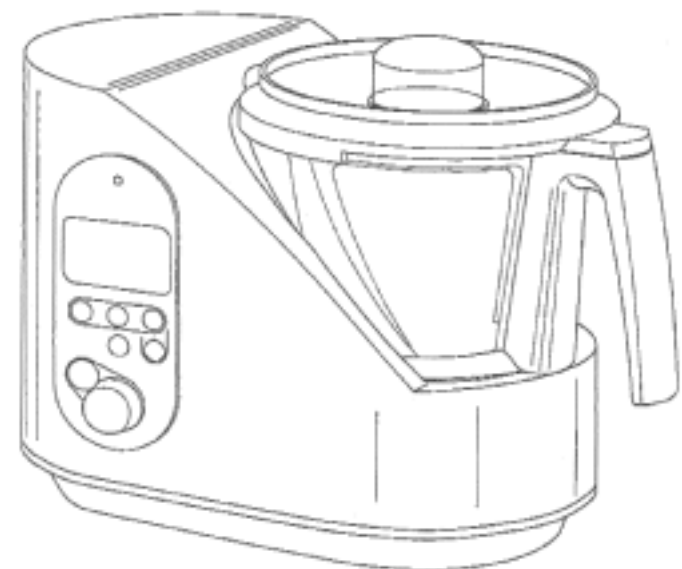

(21) Design Number: **10567/2012**
(22) Date of Filing Application: **06 February 2012**
(24) Date from which industrial property rights may have effect: **06 February 2012**
(54) Product in respect of which the design is registered: **Kitchen appliance**
(51) International Design Classification: **07-02NES**
(74) Name(s) of Attorney(s): **EKM patent & trade marks**
(71) Name(s) and Address(s) of Applicant(s):
Vendall Comercial 2003 S.L.
C/- Rita Bonnat 9 y 11 esq. Loreto 08029 Barcelona Spain
(72) Name(s) of Designer(s): **Jose M. Grife de Pascual**
(45) Registration Date: **18 April 2012**
(56) Related Art Documents: **Not Applicable**
(57) Statement of Newness and Distinctiveness: **Nil**

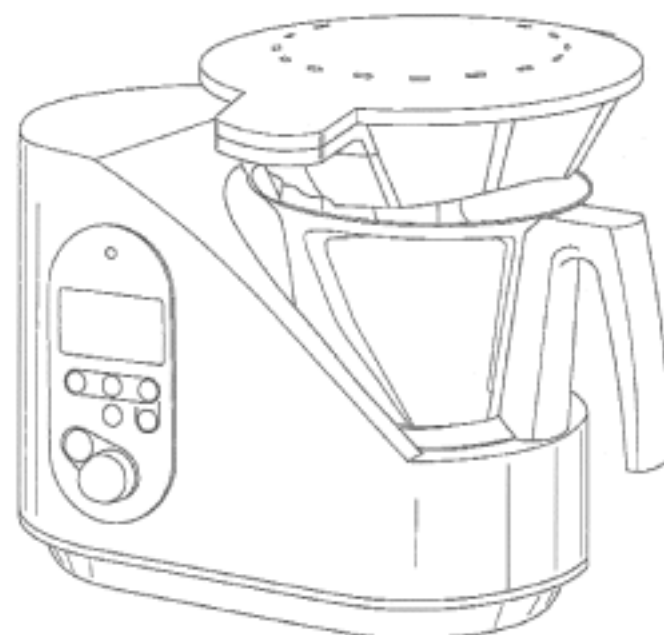

(21) Design Number: **10784/2012**
(22) Date of Filing Application: **17 February 2012**
(24) Date from which industrial property rights may have effect: **17 February 2012**
(54) Product in respect of which the design is registered: **Fluid end**
(51) International Design Classification: **23-01K**
(74) Name(s) of Attorney(s): **Davies Collison Cave**
(71) Name(s) and Address(s) of Applicant(s):
S.P.M. Flow Control, Inc.
7601 Wyatt Drive Fort Worth Texas 76108 United States of America
(72) Name(s) of Designer(s): **Mark D. Matzner**
(45) Registration Date: **18 April 2012**
(30) Convention priority data:
(31) Number (32) Date (33) Country
29/399897 19 Aug 2011 UNITED STATES OF AMERICA
(56) Related Art Documents: **Not Applicable**
(57) Statement of Newness and Distinctiveness: **Newness and distinctiveness is claimed in the visual features shown in solid lines in the representations.**

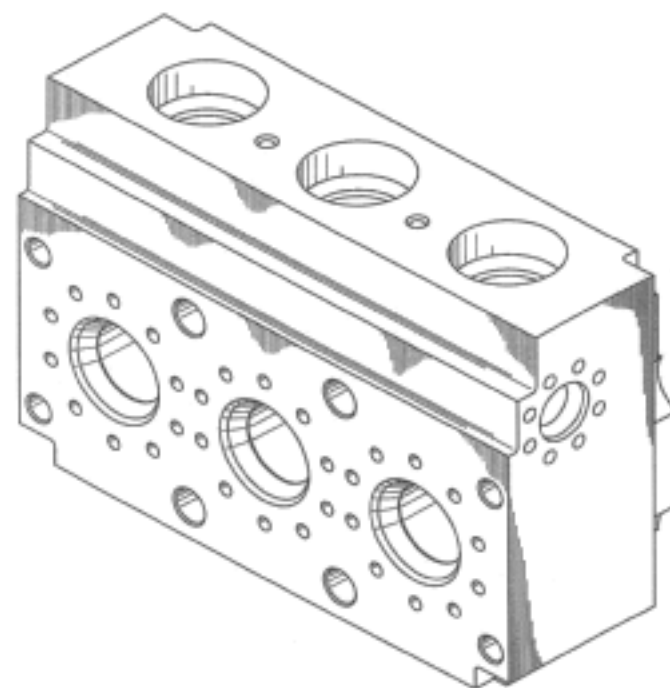

- (21) Design Number: **10961/2012**
(22) Date of Filing Application: **29 February 2012**
(24) Date from which industrial property rights may have effect: **29 February 2012**
(54) Product in respect of which the design is registered: **Table top**
(51) International Design Classification: **06-03B**
(74) Name(s) of Attorney(s): **Griffith Hack**
(71) Name(s) and Address(s) of Applicant(s):
Lifetime Products, Inc.
Freeport Center Building D-11 Clearfield UT 84016 United States of America
(72) Name(s) of Designer(s): **Frank Clegg and Wendell Peery**
(45) Registration Date: **18 April 2012**
(30) Convention priority data:
(31) Number (32) Date (33) Country
29/400,986 05 Sep 2011 UNITED STATES OF AMERICA
(56) Related Art Documents: **Not Applicable**
(57) Statement of Newness and Distinctiveness: **Newness and distinctiveness is shown in the shape and configuration of the product as illustrated and having particular regard to those features shown in solid lines.**

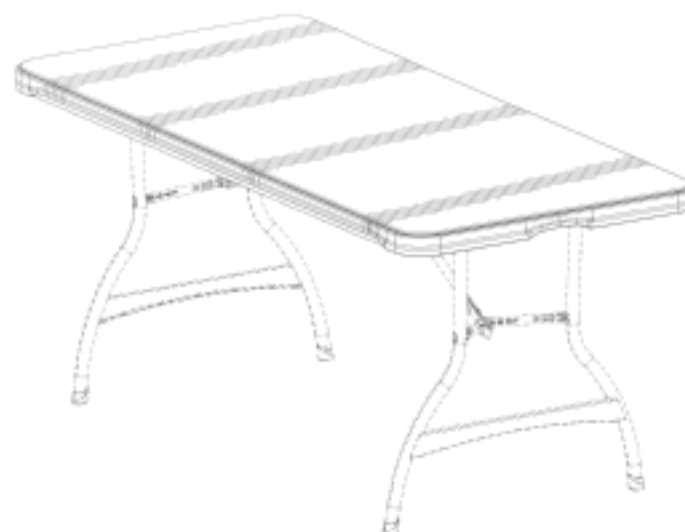

- (21) Design Number: **10988/2012**
(22) Date of Filing Application: **01 March 2012**
(24) Date from which industrial property rights may have effect: **01 March 2012**
(54) Product in respect of which the design is registered: **Knee pad**
(51) International Design Classification: **21-02NES**
(74) Name(s) of Attorney(s): **Davies Collison Cave**
(71) Name(s) and Address(s) of Applicant(s):
Baby Bumpers Pty Ltd
2/10 Lemmon Street Williamstown North Victoria 3016 Australia
(72) Name(s) of Designer(s): **Jennifer Carey**
(45) Registration Date: **18 April 2012**
(56) Related Art Documents: **Not Applicable**
(57) Statement of Newness and Distinctiveness: **The features of shape and configuration of the knee pad shown in the accompanying representations are considered to be new and distinctive.**

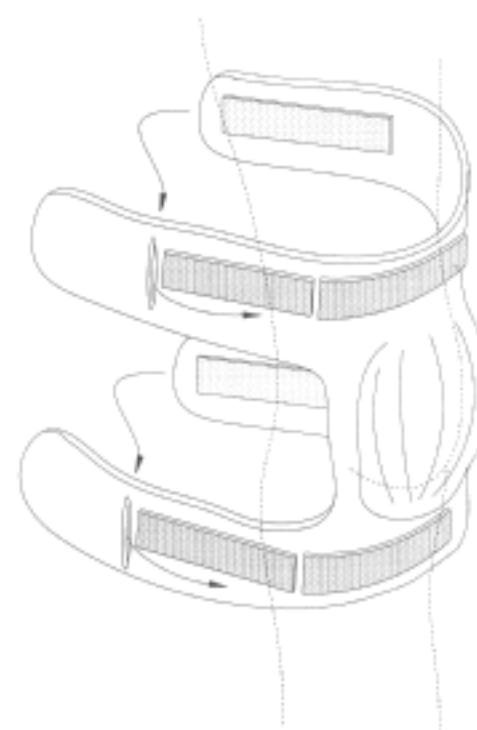

(21) Design Number: **11097/2012**
(22) Date of Filing Application: **06 March 2012**
(24) Date from which industrial property rights may have effect: **06 March 2012**
(54) Product in respect of which the design is registered: **Lid for tub**
(51) International Design Classification: **09-07B**
(74) Name(s) of Attorney(s): **Davies Collison Cave**
(71) Name(s) and Address(s) of Applicant(s):
Unilever PLC
Unilever House 100 Victoria Embankment London EC4Y ODY United Kingdom
(72) Name(s) of Designer(s): **James Garfield Pryor**
(45) Registration Date: **18 April 2012**
(30) Convention priority data:
(31) Number (32) Date (33) Country
001919176-0001 19 Sep 2011 EUROPEAN COMMUNITY
(56) Related Art Documents: **Not Applicable**
(57) Statement of Newness and Distinctiveness: **Newness and distinctiveness is claimed in the visual features shown in solid lines in the representations.**

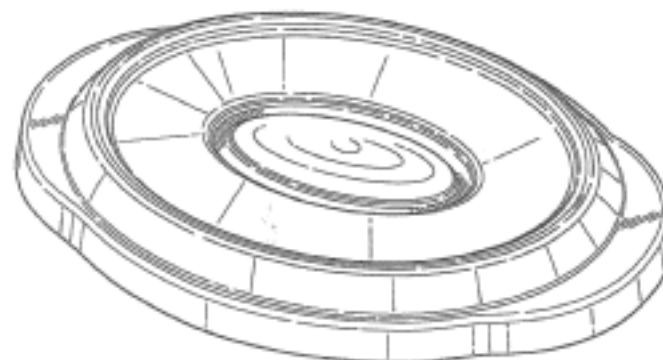

(21) Design Number: **11098/2012**
(22) Date of Filing Application: **06 March 2012**
(24) Date from which industrial property rights may have effect: **06 March 2012**
(54) Product in respect of which the design is registered: **Tub**
(51) International Design Classification: **09-03NES**
(74) Name(s) of Attorney(s): **Davies Collison Cave**
(71) Name(s) and Address(s) of Applicant(s):
Unilever PLC
Unilever House 100 Victoria Embankment London EC4Y ODY United Kingdom
(72) Name(s) of Designer(s): **James Garfield Pryor**
(45) Registration Date: **18 April 2012**
(30) Convention priority data:
(31) Number (32) Date (33) Country
001919168-0001 19 Sep 2011 EUROPEAN COMMUNITY
(56) Related Art Documents: **Not Applicable**
(57) Statement of Newness and Distinctiveness: **Newness and distinctiveness is claimed in the visual features shown in solid lines in the representations.**

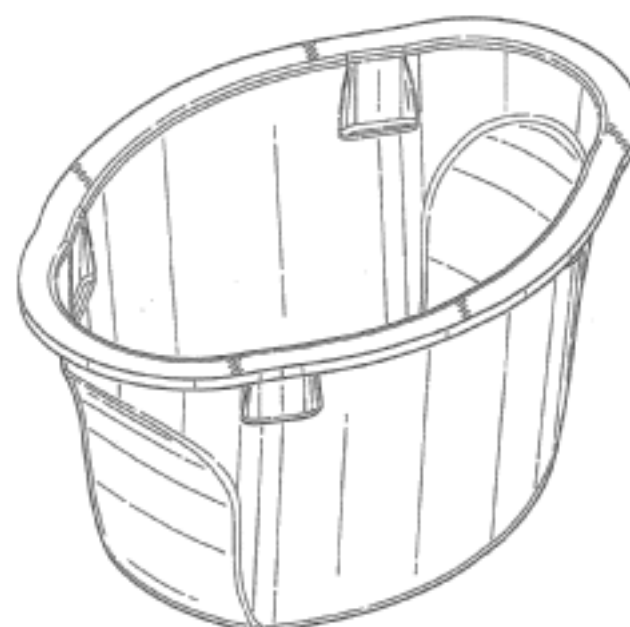

(21) Design Number: **10303/2012**
(22) Date of Filing Application: **19 January 2012**
(24) Date from which industrial property rights may have effect: **19 January 2012**
(54) Product in respect of which the design is registered: **Multi stage evaporative cooler**
(51) International Design Classification: **23-04**
(74) Name(s) of Attorney(s):
(71) Name(s) and Address(s) of Applicant(s):
F F Seeley Nominees Pty Ltd
PO Box 164 Lonsdale South Australia 5160 Australia
(72) Name(s) of Designer(s): **Robert Gilbert and Michael Pugh**
(45) Registration Date: **18 April 2012**
(56) Related Art Documents: **Not Applicable**
(57) Statement of Newness and Distinctiveness: **Nil**

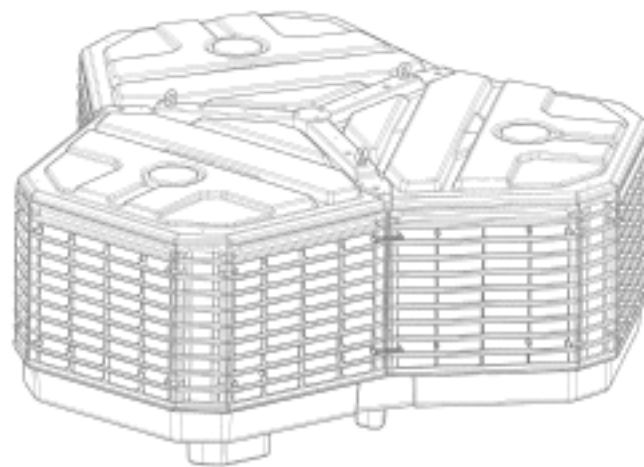

(21) Design Number: **11249/2012**
(22) Date of Filing Application: **07 March 2012**
(24) Date from which industrial property rights may have effect: **07 March 2012**
(54) Product in respect of which the design is registered: **Display screen with icon**
(51) International Design Classification: **14-04**
(74) Name(s) of Attorney(s): **Shelston IP**
(71) Name(s) and Address(s) of Applicant(s):
Microsoft Corporation
One Microsoft Way Redmond Washington 98052 United States of America
(72) Name(s) of Designer(s): **Kieran Phelan**
(45) Registration Date: **18 April 2012**
(30) Convention priority data:
(31) Number (32) Date (33) Country
29/401382 12 Sep 2011 UNITED STATES OF AMERICA
(56) Related Art Documents: **Not Applicable**
(57) Statement of Newness and Distinctiveness: **Newness and distinctiveness reside in the pattern and/or ornamentation of a display screen with icon as illustrated by solid lines in the accompanying representations. The features shown in broken outline are for illustrative purposes only and do not form part of the design.**

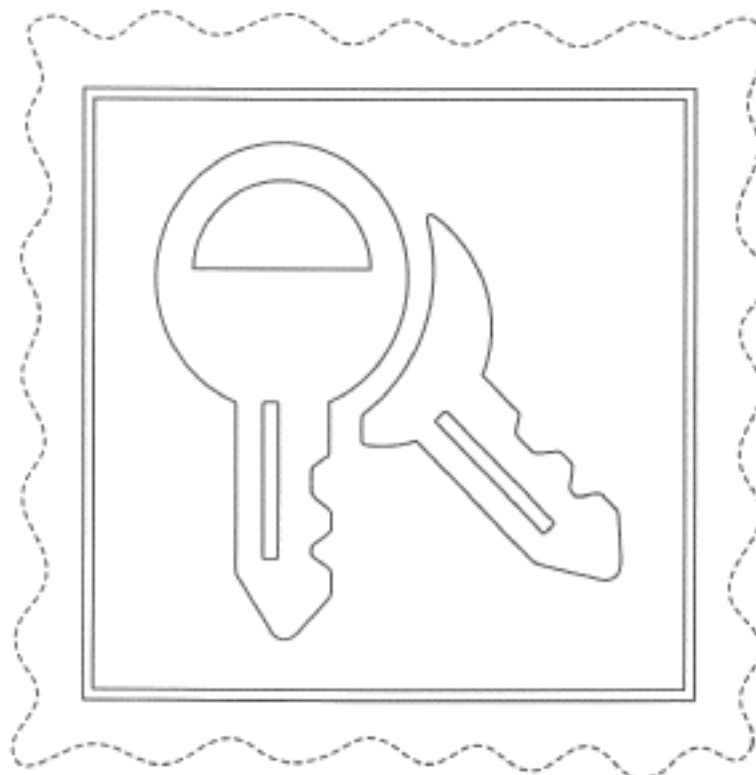

(21) Design Number: **11250/2012**
(22) Date of Filing Application: **07 March 2012**
(24) Date from which industrial property rights may have effect: **07 March 2012**
(54) Product in respect of which the design is registered: **Display screen with icon**
(51) International Design Classification: **14-04**
(74) Name(s) of Attorney(s): **Shelston IP**
(71) Name(s) and Address(s) of Applicant(s):
Microsoft Corporation
One Microsoft Way Redmond Washington 98052 United States of America
(72) Name(s) of Designer(s): **Kieran Phelan and Scott Randall and Randy Winjum and Jon Briner**
(45) Registration Date: **18 April 2012**
(30) Convention priority data:
(31) Number (32) Date (33) Country
29/401386 12 Sep 2011 UNITED STATES OF AMERICA
(56) Related Art Documents: **Not Applicable**
(57) Statement of Newness and Distinctiveness: **Newness and distinctiveness reside in the pattern and/or ornamentation of a display screen with icon as illustrated by solid lines in the accompanying representations. The features shown in broken outline are for illustrative purposes only and do not form part of the design.**

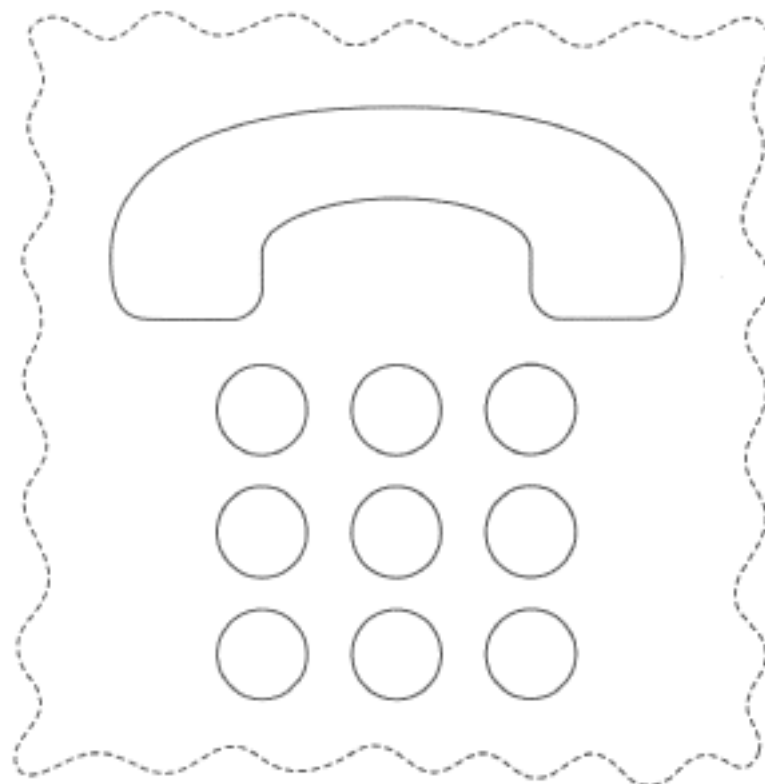

(21) Design Number: **11251/2012**
(22) Date of Filing Application: **07 March 2012**
(24) Date from which industrial property rights may have effect: **07 March 2012**
(54) Product in respect of which the design is registered: **Display screen with icon set**
(51) International Design Classification: **14-04**
(74) Name(s) of Attorney(s): **Shelston IP**
(71) Name(s) and Address(s) of Applicant(s):
Microsoft Corporation
One Microsoft Way Redmond Washington 98052 United States of America
(72) Name(s) of Designer(s): **Kieran Phelan and Scott Randall and Randy Winjum and Jon Briner**
(45) Registration Date: **18 April 2012**
(30) Convention priority data:
(31) Number (32) Date (33) Country
29/401384 12 Sep 2011 UNITED STATES OF AMERICA
(56) Related Art Documents: **Not Applicable**
(57) Statement of Newness and Distinctiveness: **Newness and distinctiveness reside in the pattern and/or ornamentation of a display screen with icon set as illustrated by solid lines in the accompanying representations. The features shown in broken outline are for illustrative purposes only and do not form part of the design.**

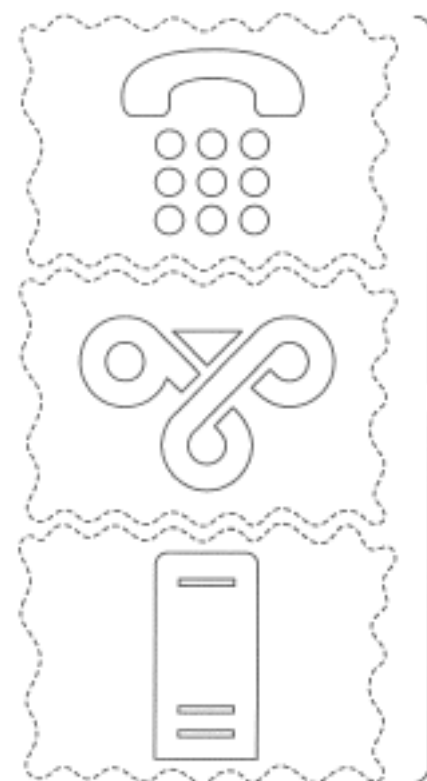

(21) Design Number: **11252/2012**
(22) Date of Filing Application: **07 March 2012**
(24) Date from which industrial property rights may have effect: **07 March 2012**
(54) Product in respect of which the design is registered: **Display screen with icon**
(51) International Design Classification: **14-04**
(74) Name(s) of Attorney(s): **Shelston IP**
(71) Name(s) and Address(s) of Applicant(s):
Microsoft Corporation
One Microsoft Way Redmond Washington 98052 United States of America
(72) Name(s) of Designer(s): **Kieran Phelan and Scott Randall and Randy Winjum and Jon Briner**
(45) Registration Date: **18 April 2012**
(30) Convention priority data:
(31) Number (32) Date (33) Country
29/401392 12 Sep 2011 UNITED STATES OF AMERICA
(56) Related Art Documents: **Not Applicable**
(57) Statement of Newness and Distinctiveness: **Newness and distinctiveness reside in the pattern and/or ornamentation of a display screen with icon as illustrated by solid lines in the accompanying representations. The features shown in broken outline are for illustrative purposes only and do not form part of the design.**

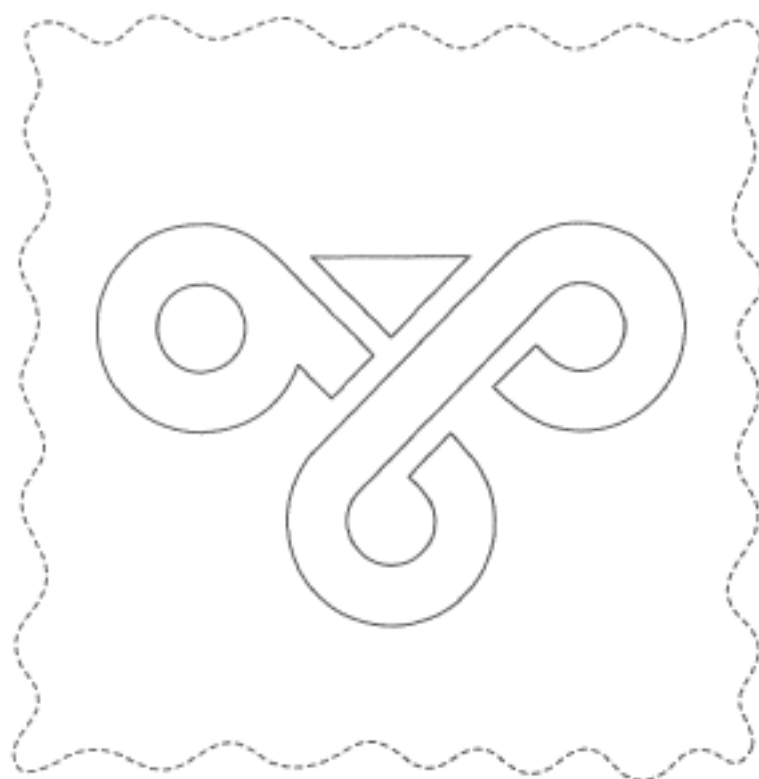

(21) Design Number: **11253/2012**
(22) Date of Filing Application: **07 March 2012**
(24) Date from which industrial property rights may have effect: **07 March 2012**
(54) Product in respect of which the design is registered: **Display screen with icon**
(51) International Design Classification: **14-04**
(74) Name(s) of Attorney(s): **Shelston IP**
(71) Name(s) and Address(s) of Applicant(s):
Microsoft Corporation
One Microsoft Way Redmond Washington 98052 United States of America
(72) Name(s) of Designer(s): **Kieran Phelan and Scott Randall and Randy Winjum and Jon Briner**
(45) Registration Date: **18 April 2012**
(30) Convention priority data:
(31) Number (32) Date (33) Country
29/401395 12 Sep 2011 UNITED STATES OF AMERICA
(56) Related Art Documents: **Not Applicable**
(57) Statement of Newness and Distinctiveness: **Newness and distinctiveness reside in the pattern and/or ornamentation of a display screen with icon as illustrated by solid lines in the accompanying representations. The features shown in broken outline are for illustrative purposes only and do not form part of the design.**

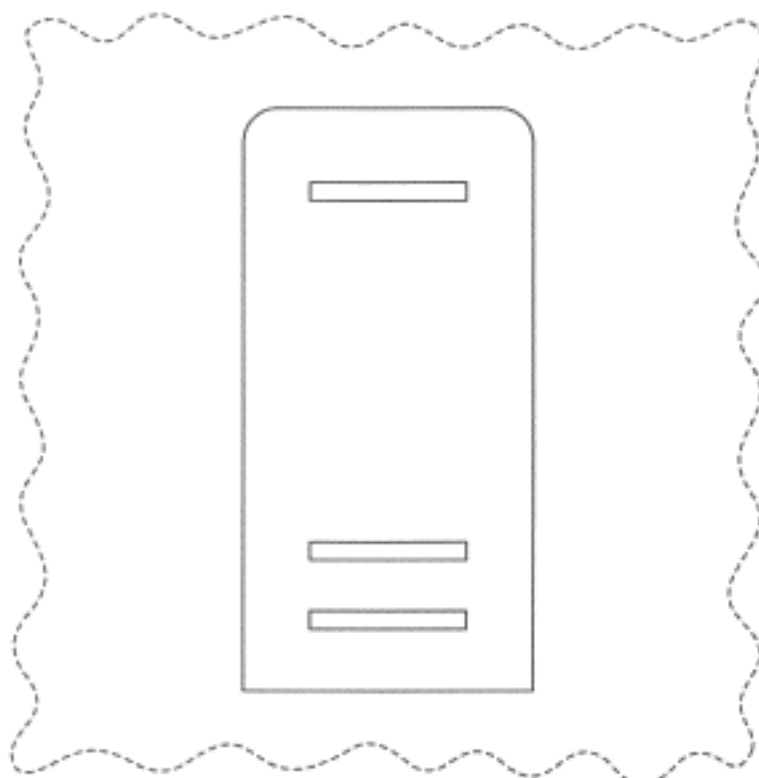

(21) Design Number: **11254/2012**
(22) Date of Filing Application: **07 March 2012**
(24) Date from which industrial property rights may have effect: **07 March 2012**
(54) Product in respect of which the design is registered: **Display screen with icon**
(51) International Design Classification: **14-04**
(74) Name(s) of Attorney(s): **Shelston IP**
(71) Name(s) and Address(s) of Applicant(s):

Microsoft Corporation
One Microsoft Way Redmond Washington 98052 United States of America

(72) Name(s) of Designer(s): **Kieran Phelan**

(45) Registration Date: **18 April 2012**

(30) Convention priority data:

(31) Number	(32) Date	(33) Country
29/401393	12 Sep 2011	UNITED STATES OF AMERICA

(56) Related Art Documents: **Not Applicable**

(57) Statement of Newness and Distinctiveness: **Newness and distinctiveness reside in the pattern and/or ornamentation of a display screen with icon as illustrated by solid lines in the accompanying representations. The features shown in broken outline are for illustrative purposes only and do not form part of the design.**

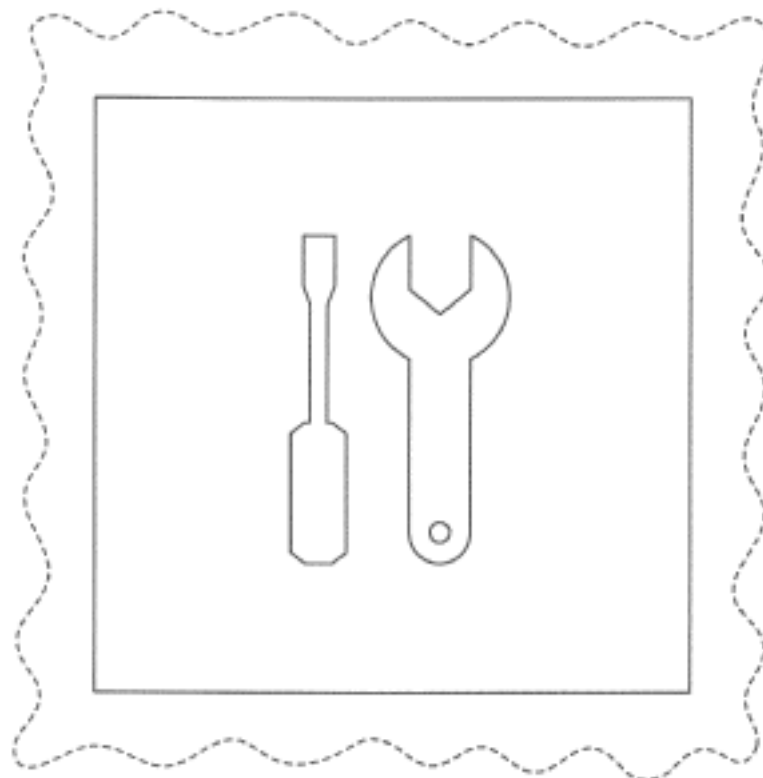

(21) Design Number: **11255/2012**
(22) Date of Filing Application: **07 March 2012**
(24) Date from which industrial property rights may have effect: **07 March 2012**
(54) Product in respect of which the design is registered: **Display screen with icon**
(51) International Design Classification: **14-04**
(74) Name(s) of Attorney(s): **Shelston IP**
(71) Name(s) and Address(s) of Applicant(s):

Microsoft Corporation
One Microsoft Way Redmond Washington 98052 United States of America

(72) Name(s) of Designer(s): **Kieran Phelan**

(45) Registration Date: **18 April 2012**

(30) Convention priority data:

(31) Number	(32) Date	(33) Country
29/401405	12 Sep 2011	UNITED STATES OF AMERICA

(56) Related Art Documents: **Not Applicable**

(57) Statement of Newness and Distinctiveness: **Newness and distinctiveness reside in the pattern and/or ornamentation of a display screen with icon as illustrated by solid lines in the accompanying representations. The features shown in broken outline are for illustrative purposes only and do not form part of the design.**

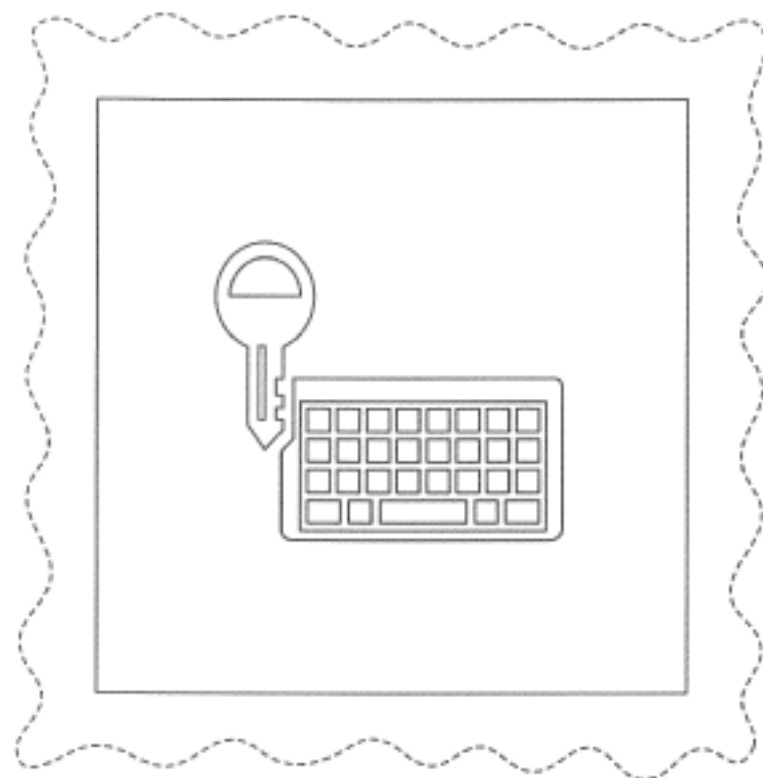

(21) Design Number: **11256/2012**
(22) Date of Filing Application: **07 March 2012**
(24) Date from which industrial property rights may have effect: **07 March 2012**
(54) Product in respect of which the design is registered: **Display screen with icon**
(51) International Design Classification: **14-04**
(74) Name(s) of Attorney(s): **Shelston IP**
(71) Name(s) and Address(s) of Applicant(s):

Microsoft Corporation
One Microsoft Way Redmond Washington 98052 United States of America

(72) Name(s) of Designer(s): **Kieran Phelan**

(45) Registration Date: **18 April 2012**

(30) Convention priority data:

(31) Number	(32) Date	(33) Country
29/401402	12 Sep 2011	UNITED STATES OF AMERICA

(56) Related Art Documents: **Not Applicable**

(57) Statement of Newness and Distinctiveness: **Newness and distinctiveness reside in the pattern and/or ornamentation of a display screen with icon as illustrated by solid lines in the accompanying representations. The features shown in broken outline are for illustrative purposes only and do not form part of the design.**

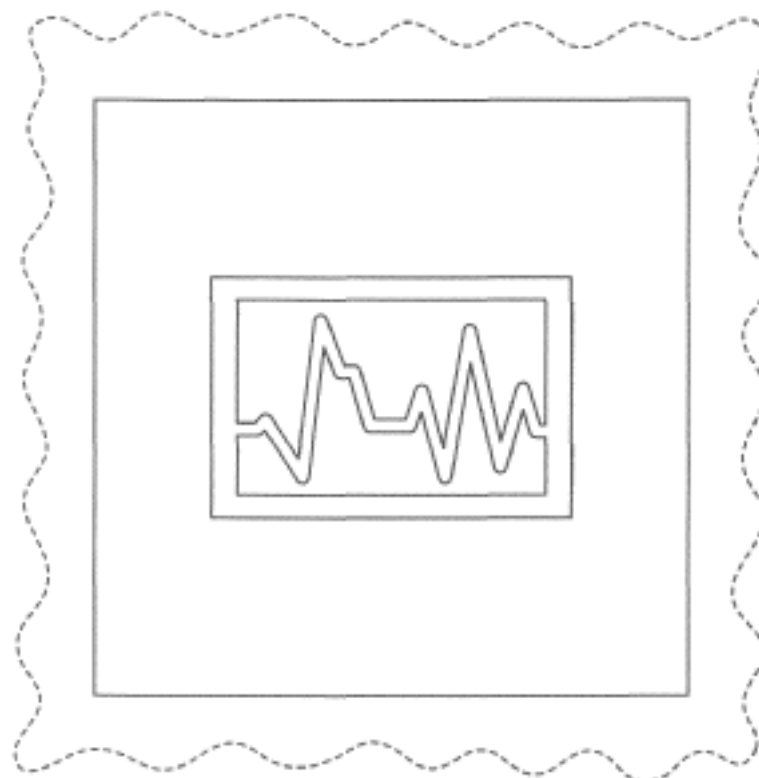

(21) Design Number: **11257/2012**
(22) Date of Filing Application: **08 March 2012**
(24) Date from which industrial property rights may have effect: **08 March 2012**
(54) Product in respect of which the design is registered: **Oral care implement package**
(51) International Design Classification: **09-05**
(74) Name(s) of Attorney(s): **FB Rice**
(71) Name(s) and Address(s) of Applicant(s):

Colgate-Palmolive Company
300 Park Avenue New York New York 10022 United States of America

(72) Name(s) of Designer(s): **Brian Bloch and David Kyung Min Lee and Alan Sorrentino and Quan Nguyen and Paul Donald Carse**

(45) Registration Date: **18 April 2012**

(30) Convention priority data:

(31) Number	(32) Date	(33) Country
29/403407	05 Oct 2011	UNITED STATES OF AMERICA

(56) Related Art Documents: **Not Applicable**

(57) Statement of Newness and Distinctiveness: **Newness and distinctiveness reside in the features of shape and configuration of the oral care implement package as shown in the representations.**

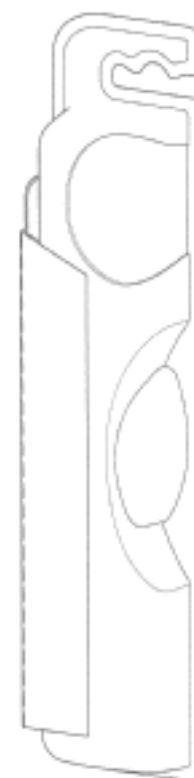

(21) Design Number: **11258/2012**
(22) Date of Filing Application: **07 March 2012**
(24) Date from which industrial property rights may have effect: **07 March 2012**
(54) Product in respect of which the design is registered: **Display screen with icon**
(51) International Design Classification: **14-04**
(74) Name(s) of Attorney(s): **Shelston IP**
(71) Name(s) and Address(s) of Applicant(s):

Microsoft Corporation
One Microsoft Way Redmond Washington 98052 United States of America

(72) Name(s) of Designer(s): **Kieran Phelan**

(45) Registration Date: **18 April 2012**

(30) Convention priority data:

(31) Number	(32) Date	(33) Country
29/401404	12 Sep 2011	UNITED STATES OF AMERICA

(56) Related Art Documents: **Not Applicable**

(57) Statement of Newness and Distinctiveness: **Newness and distinctiveness reside in the pattern and/or ornamentation of a display screen with icon as illustrated by solid lines in the accompanying representations. The features shown in broken outline are for illustrative purposes only and do not form part of the design.**

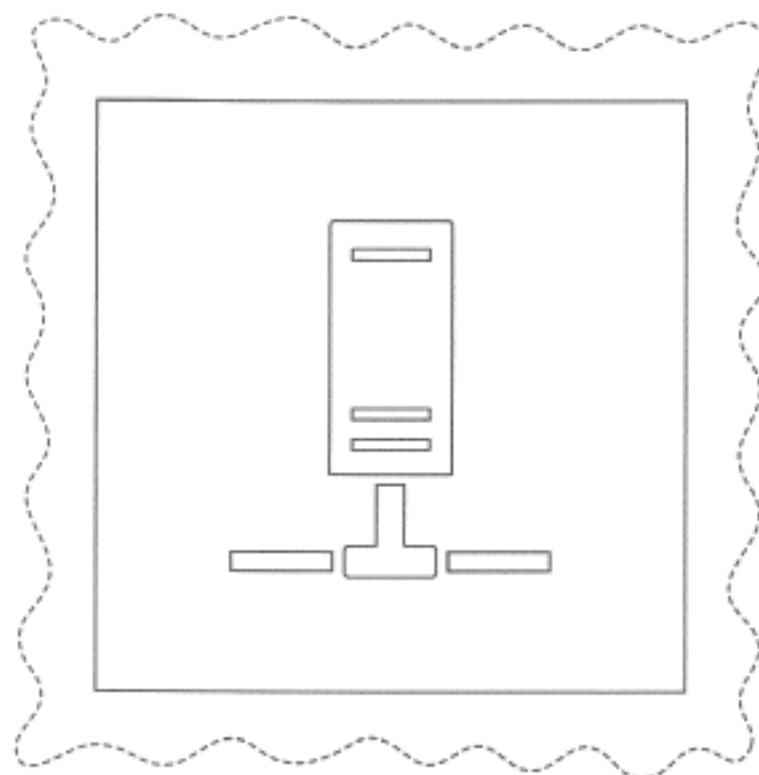

(21) Design Number: **11259/2012**
(22) Date of Filing Application: **07 March 2012**
(24) Date from which industrial property rights may have effect: **07 March 2012**
(54) Product in respect of which the design is registered: **Display screen with icon**
(51) International Design Classification: **14-04**
(74) Name(s) of Attorney(s): **Shelston IP**
(71) Name(s) and Address(s) of Applicant(s):

Microsoft Corporation
One Microsoft Way Redmond Washington 98052 United States of America

(72) Name(s) of Designer(s): **Kieran Phelan**

(45) Registration Date: **18 April 2012**

(30) Convention priority data:

(31) Number	(32) Date	(33) Country
29/401397	12 Sep 2011	UNITED STATES OF AMERICA

(56) Related Art Documents: **Not Applicable**

(57) Statement of Newness and Distinctiveness: **Newness and distinctiveness reside in the pattern and/or ornamentation of a display screen with icon as illustrated by solid lines in the accompanying representations. The features shown in broken outline are for illustrative purposes only and do not form part of the design.**



(21) Design Number: **11260/2012**
(22) Date of Filing Application: **07 March 2012**
(24) Date from which industrial property rights may have effect: **07 March 2012**
(54) Product in respect of which the design is registered: **Display screen with icon**
(51) International Design Classification: **14-04**
(74) Name(s) of Attorney(s): **Shelston IP**
(71) Name(s) and Address(s) of Applicant(s):

Microsoft Corporation
One Microsoft Way Redmond Washington 98052 United States of America

(72) Name(s) of Designer(s): **Kieran Phelan**

(45) Registration Date: **18 April 2012**

(30) Convention priority data:

(31) Number	(32) Date	(33) Country
29/401399	12 Sep 2011	UNITED STATES OF AMERICA

(56) Related Art Documents: **Not Applicable**

(57) Statement of Newness and Distinctiveness: **Newness and distinctiveness reside in the pattern and/or ornamentation of a display screen with icon as illustrated by solid lines in the accompanying representations. The features shown in broken outline are for illustrative purposes only and do not form part of the design.**

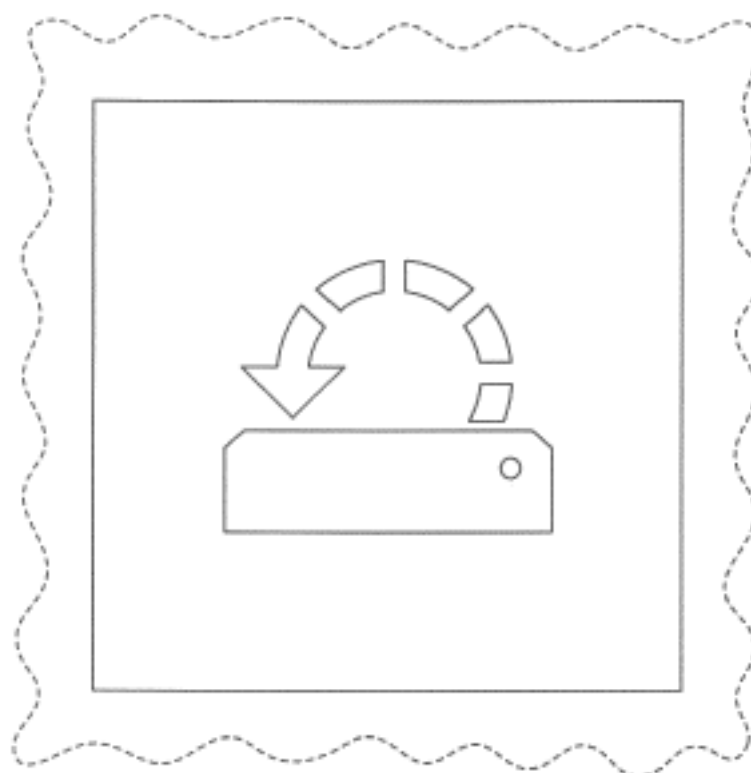

(21) Design Number: **13796/2011**
(22) Date of Filing Application: **26 August 2011**
(24) Date from which industrial property rights may have effect: **26 August 2011**
(54) Product in respect of which the design is registered: **Bin with clips**
(51) International Design Classification: **09-02A, 09-09**
(74) Name(s) of Attorney(s): **Davies Collison Cave**
(71) Name(s) and Address(s) of Applicant(s):

Willow Ware Australia Pty Ltd
60 Annandale Road Melbourne Airport Victoria 3045 Australia

(72) Name(s) of Designer(s): **David Flynn and Giovanni Ciampa**

(45) Registration Date: **18 April 2012**

(56) Related Art Documents: **Not Applicable**

(57) Statement of Newness and Distinctiveness: **Newness and distinctiveness is claimed in the visual features of shape and configuration of a bin having clips as shown in solid lines in the representations, but not in the portions of the bin shown in broken lines.**



- (21) Design Number: **14615/2011**
(22) Date of Filing Application: **12 October 2011**
(24) Date from which industrial property rights may have effect: **12 October 2011**
(54) Product in respect of which the design is registered: **A fin for a watercraft**
(51) International Design Classification: **21-02D**
(74) Name(s) of Attorney(s): **Chrysiliou IP**
(71) Name(s) and Address(s) of Applicant(s):
Paul Holliday
2 Melbourne Avenue Mona Vale New South Wales 2103 Australia
(72) Name(s) of Designer(s): **Paul Holliday**
(45) Registration Date: **18 April 2012**
(56) Related Art Documents: **Not Applicable**
(57) Statement of Newness and Distinctiveness: **Newness and distinctiveness is claimed in the features of shape and/or configuration of a fin for a watercraft as illustrated in the accompanying representations. In considering which features are new and distinctive, the features of the two lugs are to be disregarded.**

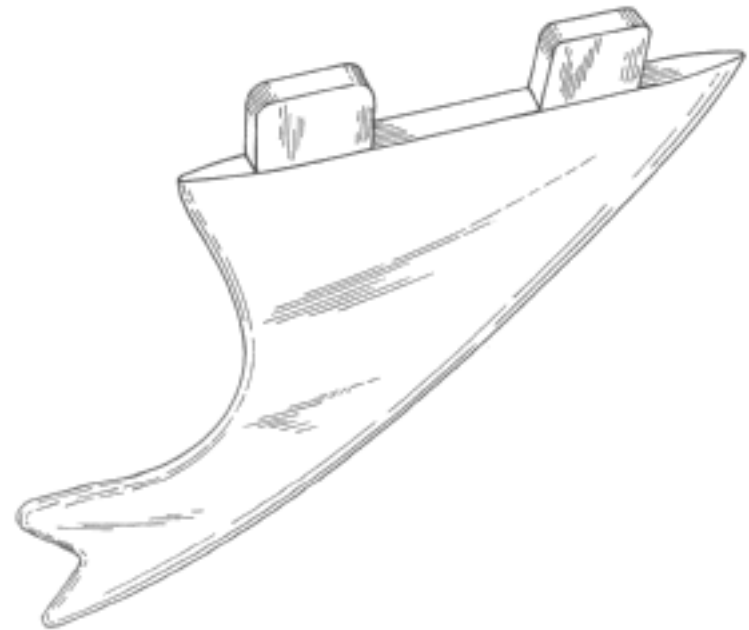

- (21) Design Number: **14632/2011**
(22) Date of Filing Application: **11 October 2011**
(24) Date from which industrial property rights may have effect: **11 October 2011**
(54) Product in respect of which the design is registered: **Side tipper door**
(51) International Design Classification: **12-16B**
(74) Name(s) of Attorney(s): **Golja Haines & Friend**
(71) Name(s) and Address(s) of Applicant(s):
Roadwest Transport Equipment & Sales Pty Ltd
100 Beechboro Road Bayswater Western Australia 6053 Australia
(72) Name(s) of Designer(s): **Peter Frank Lombardi**
(45) Registration Date: **18 April 2012**
(56) Related Art Documents: **Not Applicable**
(57) Statement of Newness and Distinctiveness: **The design resides in the shape and configuration of the door for a side tipping trailer as shown in the accompanying representations. Novelty resides in the arcuate slot in brackets at either end of the door, and in the folded portions depending inwardly from the faces of these brackets, abutting the outside of the door, and the hinge mounting plate brackets.**

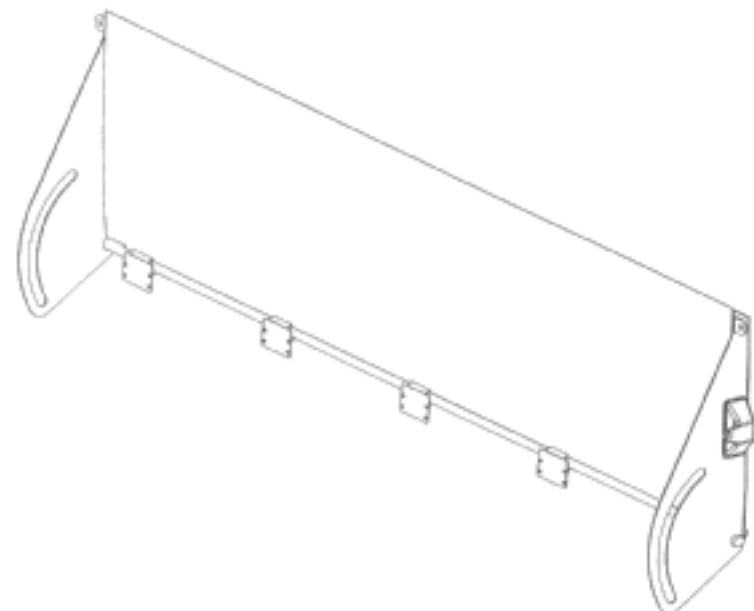

- (21) Design Number: **14635/2011**
(22) Date of Filing Application: **11 October 2011**
(24) Date from which industrial property rights may have effect: **11 October 2011**
(54) Product in respect of which the design is registered: **Front and rear side tipper door brackets**
(51) International Design Classification: **12-16B**
(74) Name(s) of Attorney(s): **Golja Haines & Friend**
(71) Name(s) and Address(s) of Applicant(s):
Roadwest Transport Equipment & Sales Pty Ltd
100 Beechboro Road Bayswater Western Australia 6053 Australia
(72) Name(s) of Designer(s): **Peter Frank Lombardi**
(45) Registration Date: **18 April 2012**
(56) Related Art Documents: **Not Applicable**
(57) Statement of Newness and Distinctiveness: **The design resides in the shape and configuration of the side tipper door brackets as shown in the accompanying representations. Novelty resides in the arcuate slot extending through from the front face to the rear face of the brackets, and in the folded portions depending from the front/rear face from one edge thereof. The brackets are mirror images of each other, but are otherwise of identical design.**

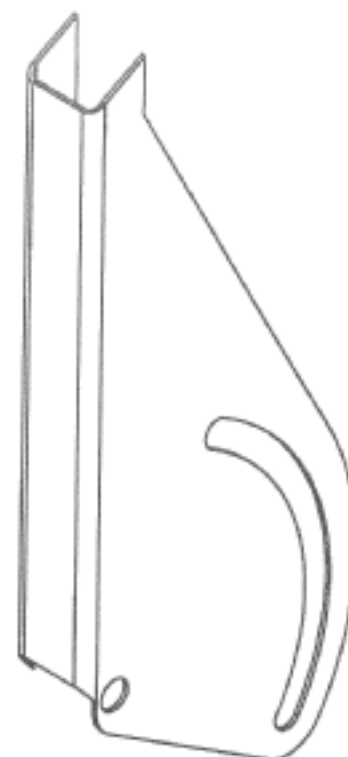

- (21) Design Number: **14895/2011**
(22) Date of Filing Application: **27 October 2011**
(24) Date from which industrial property rights may have effect: **27 October 2011**
(54) Product in respect of which the design is registered: **Waterless toilet**
(51) International Design Classification: **23-02C**
(74) Name(s) of Attorney(s):
(71) Name(s) and Address(s) of Applicant(s):
Paul Geoffrey Spittle
6 Crossland Street Esperance Western Australia 6450 Australia
(72) Name(s) of Designer(s): **Paul Spittle and Michael McMahon**
(45) Registration Date: **18 April 2012**
(56) Related Art Documents: **Not Applicable**
(57) Statement of Newness and Distinctiveness: **Newness and distinctiveness resides in the features of shape and configuration of the toilet design. In deciding if the design is substantially similar to another design disregard features shown in phantom.**

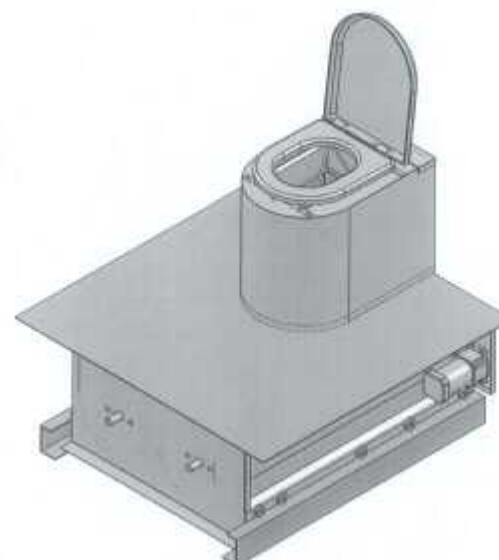

- (21) Design Number: **14896/2011**
(22) Date of Filing Application: **27 October 2011**
(24) Date from which industrial property rights may have effect: **27 October 2011**
(54) Product in respect of which the design is registered: **Waterless toilet bowl**
(51) International Design Classification: **23-02C**
(74) Name(s) of Attorney(s):
(71) Name(s) and Address(s) of Applicant(s):
Paul Geoffrey Spittle
6 Crossland Street Esperance Western Australia 6450 Australia
(72) Name(s) of Designer(s): **Paul Spittle and Michael McMahon**
(45) Registration Date: **18 April 2012**
(56) Related Art Documents: **Not Applicable**
(57) Statement of Newness and Distinctiveness: **Newness and distinctiveness resides in the features of shape and configuration of the toilet design. In deciding if the design is substantially similar to another design disregard features shown in phantom.**

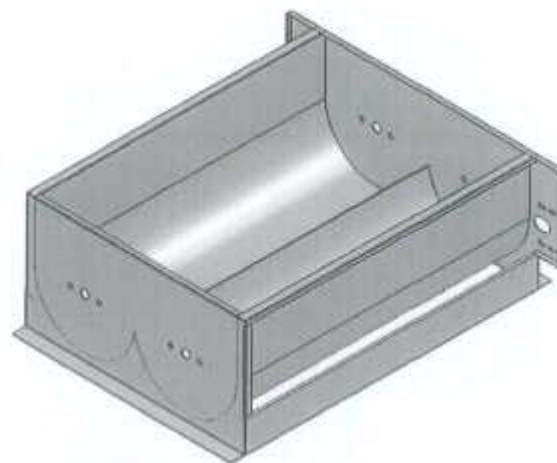

- (21) Design Number: **11428/2012**
(22) Date of Filing Application: **19 March 2012**
(24) Date from which industrial property rights may have effect: **19 March 2012**
(54) Product in respect of which the design is registered: **Multi-piece hair clipper housing lid**
(51) International Design Classification: **28-03D**
(74) Name(s) of Attorney(s): **WATERMARK PATENT AND TRADE MARKS ATTORNEYS**
(71) Name(s) and Address(s) of Applicant(s):
Wahl Clipper Corporation
2900 North Locust Street Sterling Illinois 61081 United States of America
(72) Name(s) of Designer(s): **Robert N. Buck Jr**
(45) Registration Date: **18 April 2012**
(30) Convention priority data:
(31) Number (32) Date (33) Country
29/401,989 19 Sep 2011 UNITED STATES OF AMERICA
(56) Related Art Documents: **Not Applicable**
(57) Statement of Newness and Distinctiveness: **The newness and distinctiveness resides in the features of shape and configuration as shown in the accompanying representations of a multi-piece hair clipper housing lid; the broken lines in the drawings do not form part of the claimed design.**

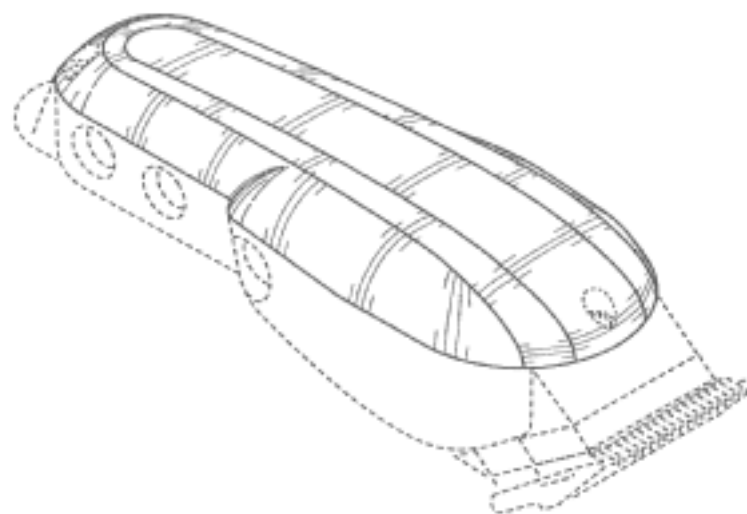

(21) Design Number: **14823/2011**
(22) Date of Filing Application: **24 October 2011**
(24) Date from which industrial property rights may have effect: **24 October 2011**
(54) Product in respect of which the design is registered: **Skirt**
(51) International Design Classification: **02-02C**
(74) Name(s) of Attorney(s): **MIDDLETONS**
(71) Name(s) and Address(s) of Applicant(s):
Beba Enterprises Pty Ltd
34 Garden Street South Yarra Victoria 3141 Australia
(72) Name(s) of Designer(s): **Arthur Soetedja**
(45) Registration Date: **19 April 2012**
(56) Related Art Documents: **Not Applicable**
(57) Statement of Newness and Distinctiveness: **Nil**



(21) Design Number: **11873/2012**
(22) Date of Filing Application: **24 October 2011**
(24) Date from which industrial property rights may have effect: **24 October 2011**
(54) Product in respect of which the design is registered: **Dress**
(51) International Design Classification: **02-02C**
(74) Name(s) of Attorney(s): **MIDDLETONS**
(71) Name(s) and Address(s) of Applicant(s):
Beba Enterprises Pty Ltd
34 Garden Street South Yarra Victoria 3141 Australia
(72) Name(s) of Designer(s): **Arthur Soetedja**
(45) Registration Date: **19 April 2012**
(56) Related Art Documents: **Not Applicable**
(57) Statement of Newness and Distinctiveness: **Nil**



(21) Design Number: **11874/2012**
(22) Date of Filing Application: **24 October 2011**
(24) Date from which industrial property rights may have effect: **24 October 2011**
(54) Product in respect of which the design is registered: **Jacket**
(51) International Design Classification: **02-02NES**
(74) Name(s) of Attorney(s): **MIDDLETONS**
(71) Name(s) and Address(s) of Applicant(s):
Beba Enterprises Pty Ltd
34 Garden Street South Yarra Victoria 3141 Australia
(72) Name(s) of Designer(s): **Arthur Soetedja**
(45) Registration Date: **19 April 2012**
(56) Related Art Documents: **Not Applicable**
(57) Statement of Newness and Distinctiveness: **Nil**



(21) Design Number: **11875/2012**
(22) Date of Filing Application: **24 October 2011**
(24) Date from which industrial property rights may have effect: **24 October 2011**
(54) Product in respect of which the design is registered: **Skirt**
(51) International Design Classification: **02-02C**
(74) Name(s) of Attorney(s): **MIDDLETONS**
(71) Name(s) and Address(s) of Applicant(s):
Beba Enterprises Pty Ltd
34 Garden Street South Yarra Victoria 3141 Australia
(72) Name(s) of Designer(s): **Arthur Soetedja**
(45) Registration Date: **19 April 2012**
(56) Related Art Documents: **Not Applicable**
(57) Statement of Newness and Distinctiveness: **Nil**



(21) Design Number: **11876/2012**
(22) Date of Filing Application: **24 October 2011**
(24) Date from which industrial property rights may have effect: **24 October 2011**
(54) Product in respect of which the design is registered: **Top**
(51) International Design Classification: **02-02NES**
(74) Name(s) of Attorney(s): **MIDDLETONS**
(71) Name(s) and Address(s) of Applicant(s):
Beba Enterprises Pty Ltd
34 Garden Street South Yarra Victoria 3141 Australia
(72) Name(s) of Designer(s): **Arthur Soetedja**
(45) Registration Date: **19 April 2012**
(56) Related Art Documents: **Not Applicable**
(57) Statement of Newness and Distinctiveness: **Nil**



(21) Design Number: **11877/2012**
(22) Date of Filing Application: **24 October 2011**
(24) Date from which industrial property rights may have effect: **24 October 2011**
(54) Product in respect of which the design is registered: **Top**
(51) International Design Classification: **02-02NES**
(74) Name(s) of Attorney(s): **MIDDLETONS**
(71) Name(s) and Address(s) of Applicant(s):
Beba Enterprises Pty Ltd
34 Garden Street South Yarra Victoria 3141 Australia
(72) Name(s) of Designer(s): **Arthur Soetedja**
(45) Registration Date: **19 April 2012**
(56) Related Art Documents: **Not Applicable**
(57) Statement of Newness and Distinctiveness: **Nil**



(21) Design Number: **11878/2012**
(22) Date of Filing Application: **24 October 2011**
(24) Date from which industrial property rights may have effect: **24 October 2011**
(54) Product in respect of which the design is registered: **Dress**
(51) International Design Classification: **02-02C**
(74) Name(s) of Attorney(s): **MIDDLETONS**
(71) Name(s) and Address(s) of Applicant(s):
Beba Enterprises Pty Ltd
34 Garden Street South Yarra Victoria 3141 Australia
(72) Name(s) of Designer(s): **Arthur Soetedja**
(45) Registration Date: **19 April 2012**
(56) Related Art Documents: **Not Applicable**
(57) Statement of Newness and Distinctiveness: **Nil**

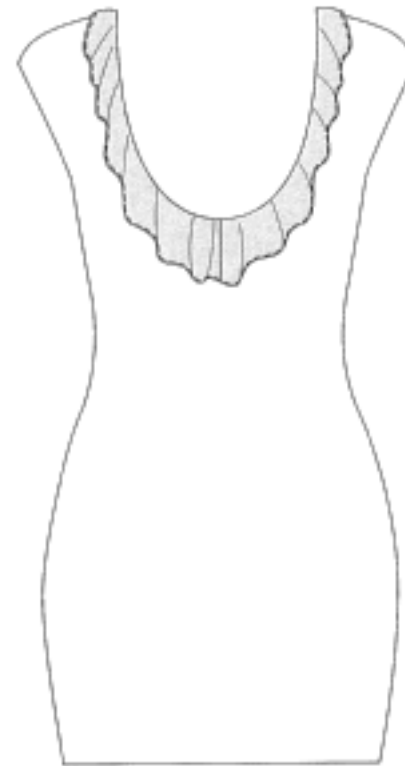

(21) Design Number: **11879/2012**
(22) Date of Filing Application: **24 October 2011**
(24) Date from which industrial property rights may have effect: **24 October 2011**
(54) Product in respect of which the design is registered: **Dress**
(51) International Design Classification: **02-02C**
(74) Name(s) of Attorney(s): **MIDDLETONS**
(71) Name(s) and Address(s) of Applicant(s):
Beba Enterprises Pty Ltd
34 Garden Street South Yarra Victoria 3141 Australia
(72) Name(s) of Designer(s): **Arthur Soetedja**
(45) Registration Date: **19 April 2012**
(56) Related Art Documents: **Not Applicable**
(57) Statement of Newness and Distinctiveness: **Nil**



- (21) Design Number: **11261/2012**
(22) Date of Filing Application: **07 March 2012**
(24) Date from which industrial property rights may have effect: **07 March 2012**
(54) Product in respect of which the design is registered: **Display screen with user interface**
(51) International Design Classification: **14-04**
(74) Name(s) of Attorney(s): **Shelston IP**
(71) Name(s) and Address(s) of Applicant(s):
Microsoft Corporation
One Microsoft Way Redmond Washington 98052 United States of America
(72) Name(s) of Designer(s): **Allison Anne Gallant and Sandy Ruoh-Ian Wu**
(45) Registration Date: **19 April 2012**
(30) Convention priority data:
(31) Number (32) Date (33) Country
29/401500 12 Sep 2011 UNITED STATES OF AMERICA
(56) Related Art Documents: **Not Applicable**
(57) Statement of Newness and Distinctiveness: **Newness and distinctiveness reside in the pattern and/or ornamentation of a display screen with user interface as illustrated by solid lines in the accompanying representations. The features shown in broken outline are for illustrative purposes only and do not form part of the design.**



- (21) Design Number: **11262/2012**
(22) Date of Filing Application: **08 March 2012**
(24) Date from which industrial property rights may have effect: **08 March 2012**
(54) Product in respect of which the design is registered: **Oral care implement package**
(51) International Design Classification: **09-05**
(74) Name(s) of Attorney(s): **FB Rice**
(71) Name(s) and Address(s) of Applicant(s):
Colgate-Palmolive Company
300 Park Avenue New York New York 10022 United States of America
(72) Name(s) of Designer(s): **Brian Bloch and David Kyung Min Lee and Alan Sorrentino and Quan Nguyen and Paul Donald Carse**
(45) Registration Date: **19 April 2012**
(30) Convention priority data:
(31) Number (32) Date (33) Country
29/403411 05 Oct 2011 UNITED STATES OF AMERICA
(56) Related Art Documents: **Not Applicable**
(57) Statement of Newness and Distinctiveness: **Newness and distinctiveness reside in the features of shape and configuration of the oral care implement package as shown in the representations excluding those features shown in broken lines.**



(21) Design Number: **11263/2012**
(22) Date of Filing Application: **07 March 2012**
(24) Date from which industrial property rights may have effect: **07 March 2012**
(54) Product in respect of which the design is registered: **Display screen with icon**
(51) International Design Classification: **14-04**
(74) Name(s) of Attorney(s): **Shelston IP**
(71) Name(s) and Address(s) of Applicant(s):

Microsoft Corporation
One Microsoft Way Redmond Washington 98052 United States of America

(72) Name(s) of Designer(s): **Kieran Phelan**

(45) Registration Date: **19 April 2012**

(30) Convention priority data:

(31) Number	(32) Date	(33) Country
29/401299	12 Sep 2011	UNITED STATES OF AMERICA

(56) Related Art Documents: **Not Applicable**

(57) Statement of Newness and Distinctiveness: **Newness and distinctiveness reside in the pattern and/or ornamentation of a display screen with icon as illustrated by solid lines in the accompanying representations. The features shown in broken outline are for illustrative purposes only and do not form part of the design.**

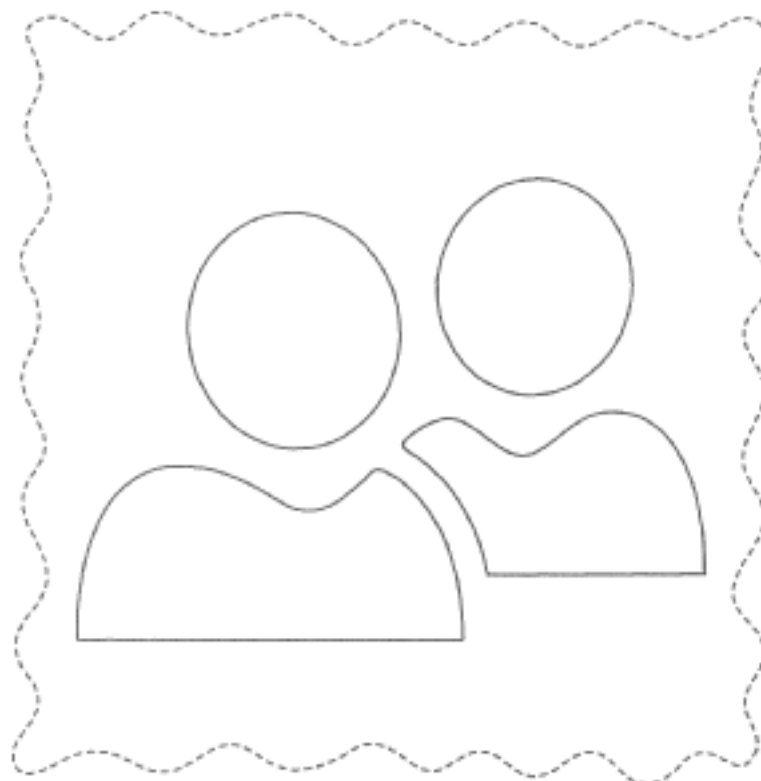

(21) Design Number: **11264/2012**
(22) Date of Filing Application: **07 March 2012**
(24) Date from which industrial property rights may have effect: **07 March 2012**
(54) Product in respect of which the design is registered: **Display screen with icon**
(51) International Design Classification: **14-04**
(74) Name(s) of Attorney(s): **Shelston IP**
(71) Name(s) and Address(s) of Applicant(s):

Microsoft Corporation
One Microsoft Way Redmond Washington 98052 United States of America

(72) Name(s) of Designer(s): **Kieran Phelan**

(45) Registration Date: **19 April 2012**

(30) Convention priority data:

(31) Number	(32) Date	(33) Country
29/401369	12 Sep 2011	UNITED STATES OF AMERICA

(56) Related Art Documents: **Not Applicable**

(57) Statement of Newness and Distinctiveness: **Newness and distinctiveness reside in the pattern and/or ornamentation of a display screen with icon as illustrated by solid lines in the accompanying representations. The features shown in broken outline are for illustrative purposes only and do not form part of the design.**

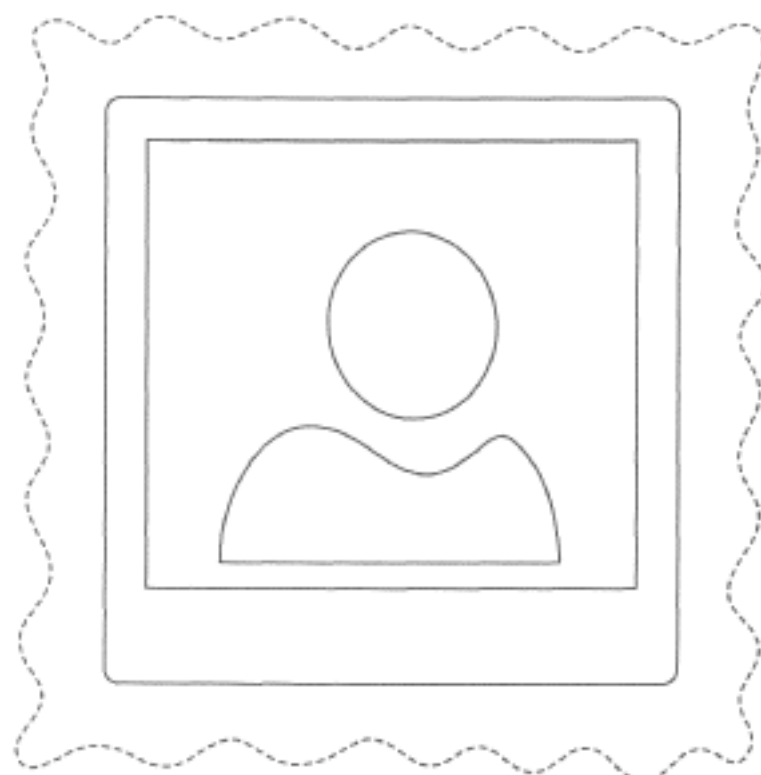

(21) Design Number: **11265/2012**
(22) Date of Filing Application: **07 March 2012**
(24) Date from which industrial property rights may have effect: **07 March 2012**
(54) Product in respect of which the design is registered: **Display screen with icon**
(51) International Design Classification: **14-04**
(74) Name(s) of Attorney(s): **Shelston IP**
(71) Name(s) and Address(s) of Applicant(s):

Microsoft Corporation
One Microsoft Way Redmond Washington 98052 United States of America

(72) Name(s) of Designer(s): **Kieran Phelan**

(45) Registration Date: **19 April 2012**

(30) Convention priority data:

(31) Number	(32) Date	(33) Country
29/401372	12 Sep 2011	UNITED STATES OF AMERICA

(56) Related Art Documents: **Not Applicable**

(57) Statement of Newness and Distinctiveness: **Newness and distinctiveness reside in the pattern and/or ornamentation of a display screen with icon as illustrated by solid lines in the accompanying representations. The features shown in broken outline are for illustrative purposes only and do not form part of the design.**

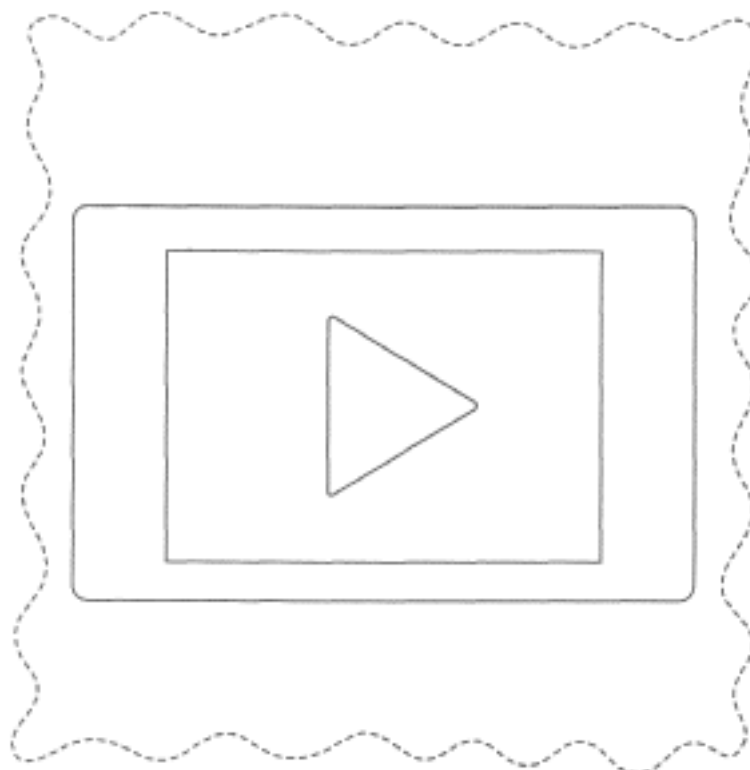

(21) Design Number: **11266/2012**
(22) Date of Filing Application: **07 March 2012**
(24) Date from which industrial property rights may have effect: **07 March 2012**
(54) Product in respect of which the design is registered: **Display screen with icon group**
(51) International Design Classification: **14-04**
(74) Name(s) of Attorney(s): **Shelston IP**
(71) Name(s) and Address(s) of Applicant(s):

Microsoft Corporation
One Microsoft Way Redmond Washington 98052 United States of America

(72) Name(s) of Designer(s): **Neils Van Dongen and Kieran Phelan and Randy Winjum and Bennett Hornbostel and Vincent Celie**

(45) Registration Date: **19 April 2012**

(30) Convention priority data:

(31) Number	(32) Date	(33) Country
29/401529	12 Sep 2011	UNITED STATES OF AMERICA

(56) Related Art Documents: **Not Applicable**

(57) Statement of Newness and Distinctiveness: **Newness and distinctiveness reside in the pattern and/or ornamentation of a display screen with icon group as illustrated by solid lines in the accompanying representations. The features shown in broken outline are for illustrative purposes only and do not form part of the design.**



(21) Design Number: **11267/2012**
(22) Date of Filing Application: **07 March 2012**
(24) Date from which industrial property rights may have effect: **07 March 2012**
(54) Product in respect of which the design is registered: **Display screen with icon**
(51) International Design Classification: **14-04**
(74) Name(s) of Attorney(s): **Shelston IP**
(71) Name(s) and Address(s) of Applicant(s):

Microsoft Corporation
One Microsoft Way Redmond Washington 98052 United States of America

(72) Name(s) of Designer(s): **Kieran Phelan**

(45) Registration Date: **19 April 2012**

(30) Convention priority data:

(31) Number	(32) Date	(33) Country
29/401453	12 Sep 2011	UNITED STATES OF AMERICA

(56) Related Art Documents: **Not Applicable**

(57) Statement of Newness and Distinctiveness: **Newness and distinctiveness reside in the pattern and/or ornamentation of a display screen with icon as illustrated by solid lines in the accompanying representations. The features shown in broken outline are for illustrative purposes only and do not form part of the design.**

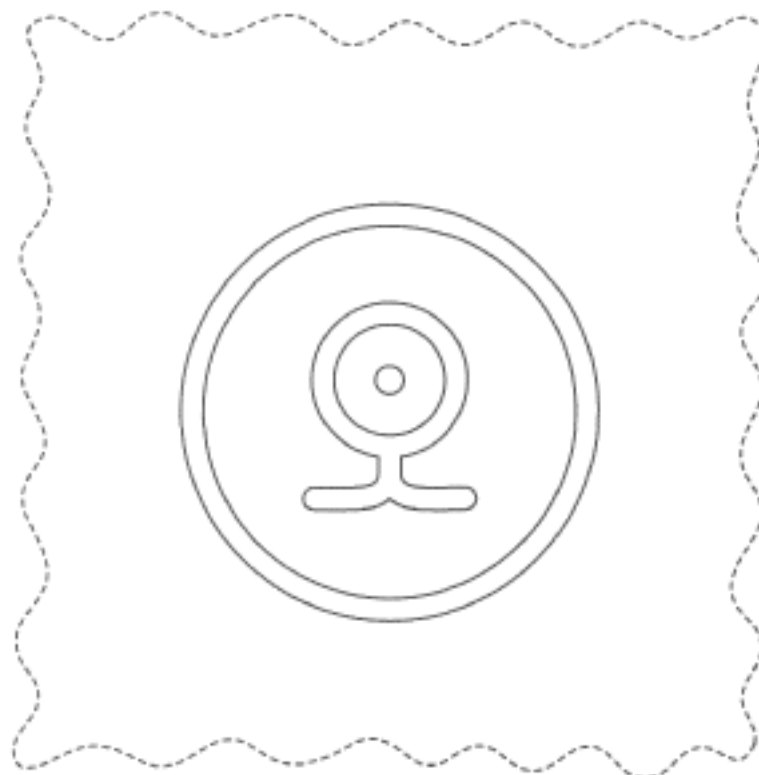

(21) Design Number: **11268/2012**
(22) Date of Filing Application: **07 March 2012**
(24) Date from which industrial property rights may have effect: **07 March 2012**
(54) Product in respect of which the design is registered: **Display screen with icon**
(51) International Design Classification: **14-04**
(74) Name(s) of Attorney(s): **Shelston IP**
(71) Name(s) and Address(s) of Applicant(s):

Microsoft Corporation
One Microsoft Way Redmond Washington 98052 United States of America

(72) Name(s) of Designer(s): **Kieran Phelan**

(45) Registration Date: **19 April 2012**

(30) Convention priority data:

(31) Number	(32) Date	(33) Country
29/401454	12 Sep 2011	UNITED STATES OF AMERICA

(56) Related Art Documents: **Not Applicable**

(57) Statement of Newness and Distinctiveness: **Newness and distinctiveness reside in the pattern and/or ornamentation of a display screen with icon as illustrated by solid lines in the accompanying representations. The features shown in broken outline are for illustrative purposes only and do not form part of the design.**



(21) Design Number: **11269/2012**
(22) Date of Filing Application: **07 March 2012**
(24) Date from which industrial property rights may have effect: **07 March 2012**
(54) Product in respect of which the design is registered: **Display screen with icon**
(51) International Design Classification: **14-04**
(74) Name(s) of Attorney(s): **Shelston IP**
(71) Name(s) and Address(s) of Applicant(s):

Microsoft Corporation
One Microsoft Way Redmond Washington 98052 United States of America

(72) Name(s) of Designer(s): **Kieran Phelan**

(45) Registration Date: **19 April 2012**

(30) Convention priority data:

(31) Number	(32) Date	(33) Country
29/401455	12 Sep 2011	UNITED STATES OF AMERICA

(56) Related Art Documents: **Not Applicable**

(57) Statement of Newness and Distinctiveness: **Newness and distinctiveness reside in the pattern and/or ornamentation of a display screen with icon as illustrated by solid lines in the accompanying representations. The features shown in broken outline are for illustrative purposes only and do not form part of the design.**

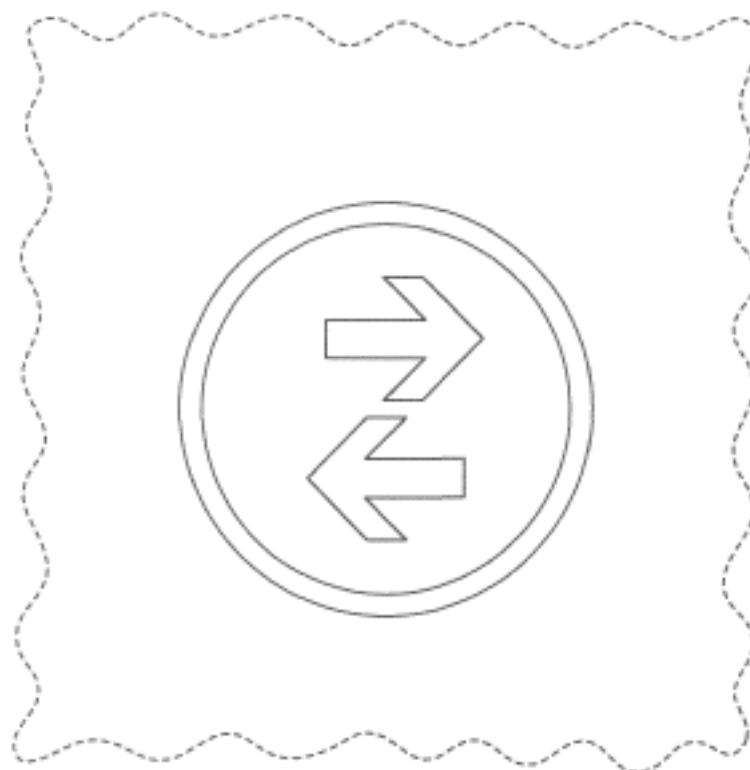

(21) Design Number: **11270/2012**
(22) Date of Filing Application: **07 March 2012**
(24) Date from which industrial property rights may have effect: **07 March 2012**
(54) Product in respect of which the design is registered: **Display screen with icon**
(51) International Design Classification: **14-04**
(74) Name(s) of Attorney(s): **Shelston IP**
(71) Name(s) and Address(s) of Applicant(s):

Microsoft Corporation
One Microsoft Way Redmond Washington 98052 United States of America

(72) Name(s) of Designer(s): **Kieran Phelan**

(45) Registration Date: **19 April 2012**

(30) Convention priority data:

(31) Number	(32) Date	(33) Country
29/401396	12 Sep 2011	UNITED STATES OF AMERICA

(56) Related Art Documents: **Not Applicable**

(57) Statement of Newness and Distinctiveness: **Newness and distinctiveness reside in the pattern and/or ornamentation of a display screen with icon as illustrated by solid lines in the accompanying representations. The features shown in broken outline are for illustrative purposes only and do not form part of the design.**

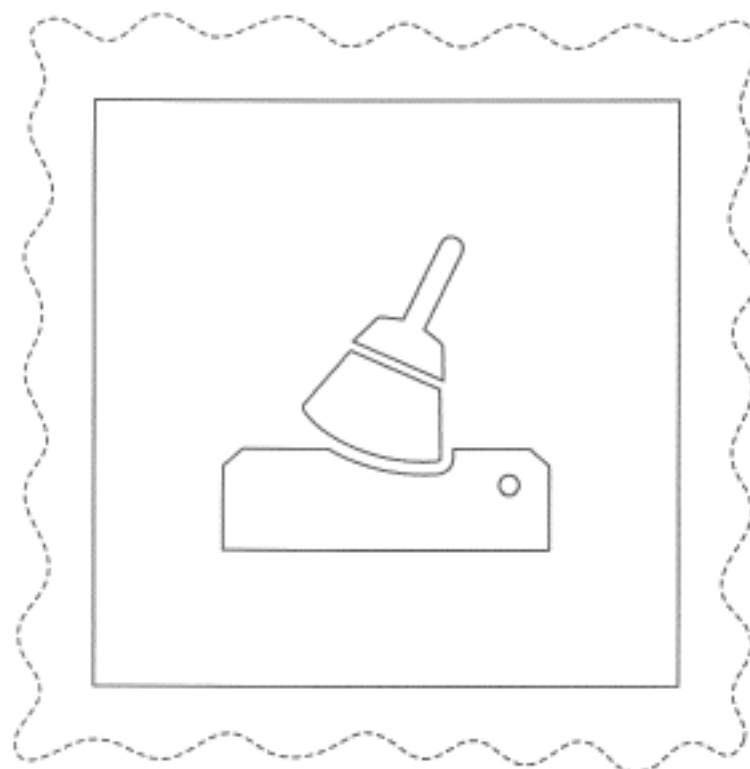

(21) Design Number: **11271/2012**
(22) Date of Filing Application: **07 March 2012**
(24) Date from which industrial property rights may have effect: **07 March 2012**
(54) Product in respect of which the design is registered: **Display screen with icon**
(51) International Design Classification: **14-04**
(74) Name(s) of Attorney(s): **Shelston IP**
(71) Name(s) and Address(s) of Applicant(s):

Microsoft Corporation
One Microsoft Way Redmond Washington 98052 United States of America

(72) Name(s) of Designer(s): **Kieran Phelan**

(45) Registration Date: **19 April 2012**

(30) Convention priority data:

(31) Number	(32) Date	(33) Country
29/401401	12 Sep 2011	UNITED STATES OF AMERICA

(56) Related Art Documents: **Not Applicable**

(57) Statement of Newness and Distinctiveness: **Newness and distinctiveness reside in the pattern and/or ornamentation of a display screen with icon as illustrated by solid lines in the accompanying representations. The features shown in broken outline are for illustrative purposes only and do not form part of the design.**

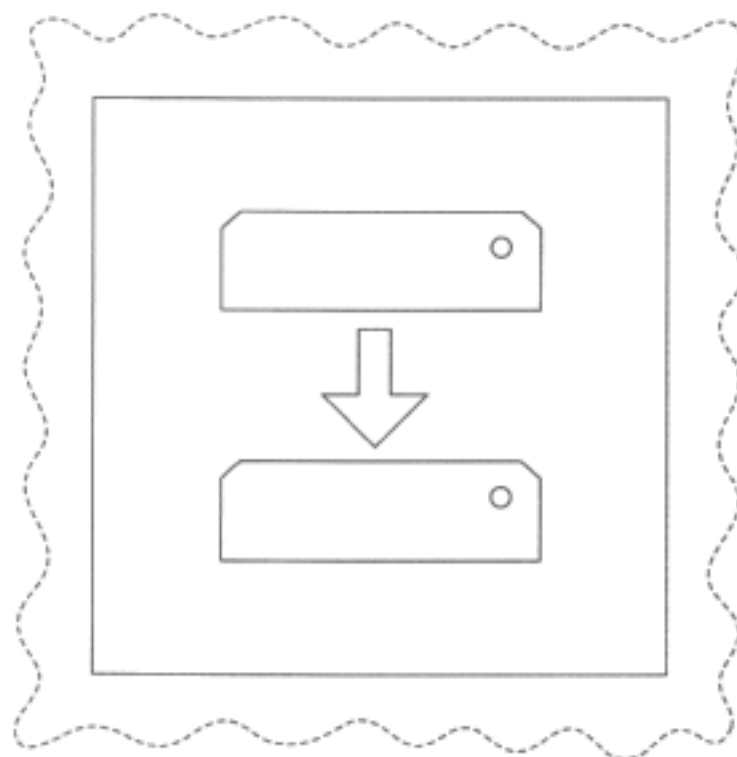

(21) Design Number: **14634/2011**
(22) Date of Filing Application: **11 October 2011**
(24) Date from which industrial property rights may have effect: **11 October 2011**
(54) Product in respect of which the design is registered: **Front and rear side tipper door seal**
(51) International Design Classification: **12-16B**
(74) Name(s) of Attorney(s): **Golja Haines & Friend**
(71) Name(s) and Address(s) of Applicant(s):

Roadwest Transport Equipment & Sales Pty Ltd
100 Beechboro Road Bayswater Western Australia 6053 Australia

(72) Name(s) of Designer(s): **Peter Frank Lombardi**

(45) Registration Date: **19 April 2012**

(56) Related Art Documents: **Not Applicable**

(57) Statement of Newness and Distinctiveness: **The design resides in the shape and configuration of the side tipper door seals as shown in the accompanying representations. The brackets are mirror images of each other, but are otherwise of identical design.**



- (21) Design Number: **14786/2011**
(22) Date of Filing Application: **21 October 2011**
(24) Date from which industrial property rights may have effect: **21 October 2011**
(54) Product in respect of which the design is registered: **Fastener insulation device**
(51) International Design Classification: **08-08NES**
(74) Name(s) of Attorney(s): **Lord & Company**
(71) Name(s) and Address(s) of Applicant(s):
Kentan Pty Ltd
PO Box 284 Maddington Western Australia 6989 Australia
(72) Name(s) of Designer(s): **Richard Lionel De Laeter**
(45) Registration Date: **19 April 2012**
(56) Related Art Documents: **Not Applicable**
(57) Statement of Newness and Distinctiveness: **The particular visual features of the design which are new and distinctive are shape and configuration.**

