



**Australian Government**

---

**IP Australia**

**AUSTRALIAN OFFICIAL JOURNAL**

**OF**

**DESIGNS**

Did you know a searchable version of this journal is now available online?

It's FREE and EASY to SEARCH.

Find it on our website ([www.ipaustralia.gov.au](http://www.ipaustralia.gov.au))

by using the "Journals" link on the home page.

This Page Left Intentionally Blank

**Contents**

**General Information & Notices**

**Proceedings Under the Designs Act 1906 preserved as a result of the provisions of Chapter 12  
Part 2 of the Designs Act 2003**

<b>Extension of Period of Registration of Designs .....</b>	<b>1398</b>
<b>Names Registered - Alterations and Amendments .....</b>	<b>1398</b>
<b>Registrations Ceased .....</b>	<b>1398</b>

**Proceedings Under the Designs Act 2003**

<b>Applications for Extension of Time Under Section 137 .....</b>	<b>1410</b>
<b>Applications Lapsed .....</b>	<b>1408</b>
<b>Applications Lodged .....</b>	<b>1402</b>
<b>Applications Withdrawn .....</b>	<b>1408</b>
<b>Certificate of Examination .....</b>	<b>1412</b>
<b>Extension of Period of Registration of Design .....</b>	<b>1410</b>
<b>Extension of Time Granted Under Section 137 .....</b>	<b>1410</b>
<b>Names Registered - Alterations and Amendments .....</b>	<b>1410</b>
<b>Publication and Registration Proceedings</b>	
<b>Designs Registered 355178 to 355315.....</b>	<b>1413</b>
<b>Registrations Ceased .....</b>	<b>1410</b>
<b>Revocation of Design Registrations .....</b>	<b>1410</b>

This Page Left Intentionally Blank

For information on the following please see our website [www.ipaustralia.gov.au](http://www.ipaustralia.gov.au) or contact our Customer Service Network on 1300651010

[Editorial enquiries](#)

[Contact information](#)

[Freedom of Information ACT](#)

[Professional Standards Board](#)

[Sales](#)

[Requests for Information under Section 194 \(c\)](#)

[Country Codes](#)

[Trade Mark and Designs Hearing Sessions](#)

[INID \(Internationally agreed Numbers for the Identification of Data\)](#)

## “INID” NUMBERS in use on Australian Design Documents

“INID” is an acronym for “Internationally agreed Numbers for the Identification of Data”.

### (10) Data concerning the registration/renewal

- (11) Serial number of the registration and/or number of the design document
- (12) Plain language designation of the kind of published document
- (19) Identification, using the two-letter code according to WIPO Standard ST.3, of the authority publishing or registering the industrial design

### (20) Data concerning the application

- (21) Serial number of the application
- (22) Date of filing of the application
- (24) Date from which the industrial design right has effect

### (30) Data relating to priority under the Paris Convention

- (31) Serial number assigned to the priority application
- (32) Date of filing of the priority application
- (33) Two-letter code, according to WIPO Standard ST.3, identifying the authority with which the priority application was made

### (40) Date(s) of making information available to the public

- (45) Date of publication of the registered industrial design by printing or similar process, or making it available to the public by any other means

### (50) Miscellaneous Information

- (51) International Classification for Industrial Designs (class and subclass of the Locarno Classification)
- (54) Designation of article(s) or product(s) covered by the industrial design or title of the industrial design
- (55) Reproduction of the industrial design (e.g., drawing, photograph) and explanations relating to the reproduction
- (56) List of prior art documents, if separate from descriptive text
- (57) Description of characteristic features of the industrial design including indication of colours

### (60) References to other legally related application(s) and registration(s)

- (62) Serial number(s) and, if available, filing date(s) of application(s), registration(s) or document(s) related by division
- (66) Serial number(s) of the application, or the registration, of the design(s) which is (are) a variant(s) of the present one

### (70) Identification of parties concerned with the application or registration

- (71) Name(s) and address(es) of the applicant(s)
- (72) Name(s) of the creator(s) if known to be such
- (74) Name(s) and address(es) of the representative(s)

This Page Left Intentionally Blank

**OFFICIAL NOTICE****Decommissioning of IP Lodgement Points**

The IP Lodgement Points will be decommissioned on 4 June 2014. Customers were informed of these changes in October 2013. The lodgement points located in the following Australia Post outlets are affected:

**Adelaide****Lodging in person:**

IP Lodgement Point  
Adelaide GPO  
141 King William Street  
Adelaide SA 5000

**Lodging via mail to an IP Lodgement Point:**

IP Lodgement Point  
Locked Bag 9854  
ADELAIDE SA 5001

**Darwin****Lodging in person:**

IP Lodgement Point  
Darwin GPO  
48 Cavenagh Street  
Darwin NT 800

**Lodging via mail to an IP Lodgement Point:**

IP Lodgement Point  
Locked Bag 9854  
DARWIN NT 0801

**Brisbane****Lodging in person:**

IP Lodgement Point  
Brisbane GPO  
261 Queen Street  
BRISBANE QLD 4000

**Lodging via mail to an IP Lodgement Point:**

IP Lodgement Point  
Locked Bag 9854  
BRISBANE QLD 4001

**Hobart****Lodging in person:**

IP Lodgement Point  
Hobart GPO  
9 Elizabeth Street  
Hobart TAS 7000

**Lodging via mail to an IP Lodgement Point:**

IP Lodgement Point  
Locked Bag 9854  
HOBART TAS 7001

## Melbourne

### Lodging in person:

IP Lodgement Point  
Melbourne GPO  
250 Elizabeth Street  
Melbourne VIC 3000

### Lodging via mail to an IP Lodgement Point:

IP Lodgement Point  
Locked Bag 9854  
MELBOURNE VIC 3001

## Sydney

### Lodging in person:

IP Lodgement Point  
Australia Post Retail Outlet  
44 Market Street  
Sydney NSW 2000

### Lodging via mail to an IP Lodgement Point:

IP Lodgement Point  
Locked Bag 9854  
SYDNEY NSW 2001

## Perth

### Lodging in person:

IP Lodgement Point  
Perth GPO  
Shops 3 and 4, 3-7 Forrest Place  
Perth WA 6000

### Lodging via mail to an IP Lodgement Point:

IP Lodgement Point  
Locked Bag 9854  
PERTH WA 6001

For more information on methods for lodgement please contact IP Australia on the means below:

**Contact:** IP Australia

**Phone:** 1300 651 010

**Web:** [www.ipaustralia.gov.au](http://www.ipaustralia.gov.au)

**OFFICIAL NOTICE****Declaration of the days from 5 June 2014, until 1 January 2015, when the Designs Office, the Patent Office, the PBR Office and the Trade Marks Office are taken not to be open for business**

The close-down provisions in the Designs, Olympic Insignia protection, Patents, Plant Breeder's Rights and Trade Marks legislation provide for the effect of Designs Office, the Patent Office, the PBR Office and the Trade Marks Office not being open for business.

On 6 May 2014, the Director General of IP Australia declared under the close-down provisions the days when the Canberra offices will not be open for business. A copy of the declaration is attached.

The Canberra offices will not be open for business on the following days in the period **5 June 2014 to 1 January 2015**.

**All the Canberra offices:**

All Saturdays and Sundays in the period

**The Canberra office**

Monday, 9 June 2014	Queen's Birthday Holiday
Monday, 29 September 2014	Family & Community Day
Monday, 6 October 2014	Labour Day
Thursday, 25 December 2014 to	
Thursday, 1 January 2015	Christmas Close Down

For more information on the effect of the close-down provisions, please see the Official Notices of 23 March 2007 titled *Intellectual Property Legislation Amendment Regulations 2007 (No. 1)* and *The new close-down provisions in the trade marks legislation* available on IP Australia's website through the page [www.ipaustralia.gov.au/resources/officialnotices.shtml](http://www.ipaustralia.gov.au/resources/officialnotices.shtml).

**Contact:** IP Australia

**Phone:** 1300 651 010

**Web:** [www.ipaustralia.gov.au](http://www.ipaustralia.gov.au)

**Proceedings under the Designs Act 1906 preserved as a result of the provisions of Chapter 12 Part 2 of the Designs Act 2003.**

This Page Left Intentionally Blank

**Applications Lapsed**

There were no Applications Lapsed under this section

**Extension of Period of Registration of Designs**

**1st Period (Section 27A(8))**

**2nd Period (Section 27A(12))**

**3rd Period (Section 27A(13))**

152506	152545	152602
152614	152615	152616
152617	152710	152739
153305	153395	153476
153594	153610	153835
154297	154319	154466
154531	155950	155968
156881		

**Registrations Ceased**

Note: Some of the following Registrations may have been previously advertised as ceased. In this instance, the previous advertisement still prevails.

133734	133999	134000
134972	134973	134974
134982	135081	135102
135119	135120	135121
135141	135156	135175
135192	135194	135301
135322	135345	135346
135347	135362	135363
135374	135397	135461
135717	135827	135866
136028	136029	136030
136031	136108	136148
136426	136519	136936
136937	137582	137907
138502	138728	138926
139215	144203	144204
144205	144206	150041
150131	150152	150232
150233	150289	150323
150324	150328	150345
150367	150371	150479
150480	150481	150482
150500	150502	150503
150520	150600	150601
150800	150859	150860
150983	151006	151024
151025	151048	151190
151423	151590	151632
151688	151689	151690
151691	151692	151712

151713	151715	151878
152177	152178	152193
152194	152195	152623
153508	153562	153564
153893	153946	154088
154381	154441	154527
154528	154625	155077
155334	155336	155337
155461	155687	155890
156312	156421	

**Names Registered - Alterations and Amendments**

(The name in parentheses is the new name of the proprietor)

156232	( Unify GmbH & Co. KG ) Siemens Enterprise Communications GMBH & Co. KG
147700	( USG BORAL BUILDING PRODUCTS PTY LIMITED ) Boral Australian Gypsum Limited
147699	( USG BORAL BUILDING PRODUCTS PTY LIMITED ) Boral Australian Gypsum Limited

This Page Left Intentionally Blank

**Proceedings under the Designs Act 2003.**

This Page Left Intentionally Blank

**Applications Lodged**

Lodgement information is in the following order: **Applicant's Name**; International Classification, Name of Product, Lodgement Date and **Design Number**. If the applicant claims an earlier priority date under an International Convention, the Convention Country and the associated filing date are shown in parentheses before the Lodgement Date. Divisional information will also appear in parentheses before the Lodgement Date.

<b>jWIN Electronics Corp.;</b> 03-01NES, A protective case, (US, 06 Dec 2013) (Divisional of 10605/2014) 30 Apr 2014	<b>12093/2014</b>	<b>Arzouman, Harry H;</b> 12-05, Jack stand, (US, 04 Nov 2013) 01 May 2014	<b>12108/2014</b>
<b>jWIN Electronics Corp.;</b> 08-07, A remote key, (US, 06 Dec 2013) (Divisional of 10605/2014) 30 Apr 2014	<b>12092/2014</b>	<b>Arzouman, David J;Arzouman, Harry H;</b> 12-02, Commercial rack for transporting jack stands, (US, 04 Nov 2013) 01 May 2014	<b>12110/2014</b>
<b>Adaptapack Pty Limited;</b> 12-05, A gripper, 28 Apr 2014	<b>12019/2014</b>	<b>Arzouman, Harry H;</b> 13-02, Power unit, (US, 04 Nov 2013) 01 May 2014	<b>12109/2014</b>
<b>Altria Client Services Inc.;</b> 27-01, Smoking article, (US, 31 Oct 2013) 30 Apr 2014	<b>12078/2014</b>	<b>Arzouman, Harry H;Arzouman, David J;</b> 12-02, Commercial rack for transporting jack stands, (US, 04 Nov 2013) 01 May 2014	<b>12110/2014</b>
<b>Altria Client Services Inc.;</b> 27-02, Smoking article, (US, 30 Oct 2013) 30 Apr 2014	<b>12075/2014</b>	<b>Atzmon, Issac;</b> 06-03NES, Furniture kit, (IL, 30 Oct 2013) 30 Apr 2014	<b>12081/2014</b>
<b>Altria Client Services Inc.;</b> 27-01, Smoking article, (US, 31 Oct 2013) 30 Apr 2014	<b>12079/2014</b>	<b>Batten, Luke;</b> 06-03A, Table, 29 Apr 2014	<b>12063/2014</b>
<b>Altria Client Services Inc.;</b> 27-02, Mouthpiece of a smoking article, (US, 30 Oct 2013) 30 Apr 2014	<b>12072/2014</b>	<b>Beats Electronics, LLC;</b> 14-01, Speaker stand, (US, 15 Nov 2013) 02 May 2014	<b>12134/2014</b>
<b>Altria Client Services Inc.;</b> 27-01, Smoking article, (US, 31 Oct 2013) 30 Apr 2014	<b>12077/2014</b>	<b>Bredemeier, Michael K;Bredemeier, Lori A;</b> 21-01NES, Teething toy for children, (US, 18 Dec 2013) 30 Apr 2014	<b>12094/2014</b>
<b>Altria Client Services Inc.;</b> 27-01, Smoking article, (US, 31 Oct 2013) 30 Apr 2014	<b>12076/2014</b>	<b>Bredemeier, Lori A;Bredemeier, Michael K;</b> 21-01NES, Teething toy for children, (US, 18 Dec 2013) 30 Apr 2014	<b>12094/2014</b>
<b>Altria Client Services Inc.;</b> 27-02, Smoking article, (US, 30 Oct 2013) 30 Apr 2014	<b>12074/2014</b>	<b>Bullet Boats Pty Ltd;</b> 12-06A, A hull for a watercraft, 06 May 2014	<b>12168/2014</b>
<b>Altro Building Systems Pty Ltd;</b> 25-02NES, Skirting board, 05 May 2014	<b>12157/2014</b>	<b>Burgis, Wayne Desmond;</b> 04-01, A mop with telescopic handle, 08 May 2014	<b>12219/2014</b>
<b>Apple Inc.;</b> 20-02NES, Display structure, (US, 16 Oct 2013) 15 Apr 2014	<b>11870/2014</b>	<b>BIOSENSE WEBSTER (ISRAEL) LTD.;</b> 14-02, 14-04, Display screen with icon, (Divisional of 10611/2014) 07 May 2014	<b>12199/2014</b>
<b>Apple Inc.;</b> 20-02NES, Display structure, (US, 16 Oct 2013) 15 Apr 2014	<b>11871/2014</b>	<b>BIOSENSE WEBSTER (ISRAEL) LTD.;</b> 14-02, Display screen with icon, (Divisional of 10611/2014) 07 May 2014	<b>12194/2014</b>
<b>Apple Inc.;</b> 20-02NES, Display structure, (US, 16 Oct 2013) 15 Apr 2014	<b>11872/2014</b>	<b>BIOSENSE WEBSTER (ISRAEL) LTD.;</b> 14-02, Display screen with icon, (Divisional of 10611/2014) 07 May 2014	<b>12187/2014</b>
<b>Apple Inc.;</b> 03-01NES, Case, (US, 22 Oct 2013) 14 Apr 2014	<b>11853/2014</b>	<b>BIOSENSE WEBSTER (ISRAEL) LTD.;</b> 14-02, Display screen with icon, (Divisional of 10611/2014) 07 May 2014	<b>12195/2014</b>
<b>Arlec Australia Pty Ltd;</b> 13-03NES, Switch button, 01 May 2014	<b>12118/2014</b>	<b>BIOSENSE WEBSTER (ISRAEL) LTD.;</b> 14-02, 14-04, Display screen with icon, (Divisional of 10611/2014) 07 May 2014	<b>12184/2014</b>
<b>Arlec Australia Pty Ltd;</b> 13-03NES, Switch button, 01 May 2014	<b>12115/2014</b>		

<b>BIOSENSE WEBSTER (ISRAEL) LTD.;</b> 14-02, Display screen with icon, (Divisional of 10611/2014) 07 May 2014	<b>12196/2014</b>	<b>Compagnie Generale Des Etablissements Michelin; Michelin Recherche et Technique S.A.;</b> 12-15A, A tyre, (FR, 15 Nov 2013) 28 Apr 2014	<b>12028/2014</b>
<b>BIOSENSE WEBSTER (ISRAEL) LTD.;</b> 14-02, Display screen with icon, (Divisional of 10611/2014) 07 May 2014	<b>12197/2014</b>	<b>Compagnie Generale Des Etablissements Michelin; Michelin Recherche et Technique S.A.;</b> 12-15C, A tyre, (US, 25 Nov 2013) 29 Apr 2014	<b>12039/2014</b>
<b>BIOSENSE WEBSTER (ISRAEL) LTD.;</b> 14-02, 14-04, Display screen with icon, (Divisional of 10611/2014) 07 May 2014	<b>12200/2014</b>	<b>CAFEA GmbH;</b> 09-01C, Glass container, (EM, 05 Nov 2013) 05 May 2014	<b>12146/2014</b>
<b>BIOSENSE WEBSTER (ISRAEL) LTD.;</b> 14-02, Display screen with icon, (Divisional of 10611/2014) 07 May 2014	<b>12193/2014</b>	<b>CAFEA GmbH;</b> 09-01C, Glass container, (EM, 05 Nov 2013) 05 May 2014	<b>12147/2014</b>
<b>BIOSENSE WEBSTER (ISRAEL) LTD.;</b> 14-02, Display screen with icon, 07 May 2014	<b>12190/2014</b>	<b>CAFEA GmbH;</b> 09-01C, Glass container, (EM, 05 Nov 2013) 05 May 2014	<b>12144/2014</b>
<b>BIOSENSE WEBSTER (ISRAEL) LTD.;</b> 14-02, 14-04, Display screen with icon, (Divisional of 10611/2014) 07 May 2014	<b>12201/2014</b>	<b>CAFEA GmbH;</b> 09-01C, Glass container, (EM, 05 Nov 2013) 05 May 2014	<b>12145/2014</b>
<b>BIOSENSE WEBSTER (ISRAEL) LTD.;</b> 14-02, 14-04, Display screen with icon, (Divisional of 10611/2014) 07 May 2014	<b>12185/2014</b>	<b>Daimler AG;</b> 12-16A, Wheel for a vehicle, (EM, 25 Nov 2013) 30 Apr 2014	<b>12083/2014</b>
<b>BIOSENSE WEBSTER (ISRAEL) LTD.;</b> 14-02, 14-04, Display screen with icon, (Divisional of 10611/2014) 07 May 2014	<b>12183/2014</b>	<b>Daimler AG;</b> 12-16A, Wheel for a vehicle, 30 Apr 2014	<b>12073/2014</b>
<b>BIOSENSE WEBSTER (ISRAEL) LTD.;</b> 14-02, Display screen with icon, (Divisional of 10611/2014) 07 May 2014	<b>12198/2014</b>	<b>Daimler AG;</b> 12-16A, Wheel for a vehicle, (EM, 25 Nov 2013) 30 Apr 2014	<b>12082/2014</b>
<b>BIOSENSE WEBSTER (ISRAEL) LTD.;</b> 14-02, 14-04, Display screen with icon, (Divisional of 10611/2014) 07 May 2014	<b>12202/2014</b>	<b>Daimler AG;</b> 12-16A, Wheel for a vehicle, 30 Apr 2014	<b>12071/2014</b>
<b>BIOSENSE WEBSTER (ISRAEL) LTD.;</b> 14-02, Display screen with icon, (Divisional of 10611/2014) 07 May 2014	<b>12191/2014</b>	<b>Daimler AG;</b> 12-16A, Wheel for a vehicle, 30 Apr 2014	<b>12085/2014</b>
<b>Care Monitoring 2000 Limited;</b> 14-99, Code generating device, (EM, 01 Nov 2013) 01 May 2014	<b>12114/2014</b>	<b>Daimler AG;</b> 12-16A, Wheel for a vehicle, 30 Apr 2014	<b>12070/2014</b>
<b>Christie, Cara;</b> 07-02H, Egg cooker, 30 Apr 2014	<b>12087/2014</b>	<b>Derlot Pty Ltd;</b> 06-01G, Composite furniture articles, 06 May 2014	<b>12170/2014</b>
<b>Colgate-Palmolive Company;</b> 04-02, Electric toothbrush handle, (US, 19 Dec 2013) 05 May 2014	<b>12151/2014</b>	<b>DG International Holdings Limited;</b> 03-01A, Luggage clip, (EM, 14 Aug 2013) (Divisional of 10687/2014) 28 Apr 2014	<b>12016/2014</b>
<b>Colgate-Palmolive Company;</b> 04-02, Refill head for electric toothbrush, (US, 19 Dec 2013) 07 May 2014	<b>12180/2014</b>	<b>DG International Holdings Limited;</b> 03-01A, Luggage clip, (EM, 14 Aug 2013) (Divisional of 10687/2014) 28 Apr 2014	<b>12018/2014</b>
<b>Colgate-Palmolive Company;</b> 04-02, Portion of refill head for electric toothbrush, (US, 19 Dec 2013) 07 May 2014	<b>12176/2014</b>	<b>Electrolux Appliances Aktiebolag;</b> 07-02L, Coffee machine water tank filter, (EP, 05 Nov 2013) 29 Apr 2014	<b>12046/2014</b>
<b>Compagnie Generale Des Etablissements Michelin; Michelin Recherche Et Technique S.A.;</b> 12-15B, A tyre, (FR, 25 Oct 2013) 11 Apr 2014	<b>11809/2014</b>	<b>Etail Investments Pty Ltd;</b> 26-06, LED driving light, 28 Apr 2014	<b>12031/2014</b>
		<b>Ethicon Endo-Surgery, Inc.;</b> 24-02, Handpiece for surgical instrument, (US, 15 Nov 2013) 28 Apr 2014	<b>12030/2014</b>
		<b>Evergreen Land Limited;</b> 22-06, Anti-insect applicator, (EM, 30 Oct 2013) 29 Apr 2014	<b>12036/2014</b>

<b>Everstone International Pty Limited;</b> 25-01F, A mosaic tile formation, 07 May 2014	<b>12203/2014</b>	<b>Higgins, Christopher Lyndon;</b> 25-01NES, Building material - folded / extruded shape, 25 Apr 2014	<b>12009/2014</b>
<b>Everstone International Pty Limited;</b> 25-01F, A mosaic tile formation, 07 May 2014	<b>12204/2014</b>	<b>Higgins, Christopher Lyndon;</b> 25-01K, Building material-folded/extruded shape, 09 May 2014	<b>12224/2014</b>
<b>Faulkner, Luke;Nicholas, Alistair;Ferguson, Greig;</b> 12-16L, A coupler, 30 Apr 2014	<b>12104/2014</b>	<b>Higgins, Christopher Lyndon;</b> 25-01NES, Building material - folded / extruded shaped sheet, 25 Apr 2014	<b>12011/2014</b>
<b>Ferguson, Greig;Nicholas, Alistair;Faulkner, Luke;</b> 12-16L, A coupler, 30 Apr 2014	<b>12104/2014</b>	<b>Higgins, Christopher Lyndon;</b> 25-01NES, Building material - simple folded / extruded shape, 25 Apr 2014	<b>12010/2014</b>
<b>Fifty-Fourth Rischell Pty Ltd;</b> 02-02NES, Mens clothing, 24 Apr 2014	<b>12095/2014</b>	<b>Hopkins, Adam;</b> 25-01A, Building block, 06 May 2014	<b>12174/2014</b>
<b>Fifty-Fourth Rischell Pty Ltd;</b> 02-02C, Men's clothing, 30 Apr 2014	<b>12103/2014</b>	<b>HENDON SEMICONDUCTORS PTY LTD;</b> 13-03NES, A base unit for an electrical dimmer, 15 Apr 2014	<b>11873/2014</b>
<b>Fifty-Fourth Rischell Pty Ltd;</b> 02-02NES, Mens clothing, 24 Apr 2014	<b>12097/2014</b>	<b>HENDON SEMICONDUCTORS PTY LTD;</b> 13-03NES, A button for an electrical push button switch, 15 Apr 2014	<b>11876/2014</b>
<b>Fifty-Fourth Rischell Pty Ltd;</b> 02-02C, Mens clothing, 24 Apr 2014	<b>12096/2014</b>	<b>HENDON SEMICONDUCTORS PTY LTD;</b> 13-03NES, A button for an electrical push button switch, 15 Apr 2014	<b>11874/2014</b>
<b>Foord, Renee;SLINGTHINGS PTY. LTD.;</b> 03-99, A baby carrier that slips on like a t-shirt, 30 Apr 2014	<b>12086/2014</b>	<b>Ideavillage Products Corporation;</b> 07-01C, Combination snack and beverage container, (US, 11 Feb 2014) 30 Apr 2014	<b>12088/2014</b>
<b>Franklin, Helen Johanna;</b> 02-02C, Women's cycling jersey- neckline/shoulder design, 05 May 2014	<b>12143/2014</b>	<b>Illinois Tool Works Inc.;</b> 08-04, Faceted bumper for fastener driver, (US, 18 Nov 2013) 15 Apr 2014	<b>11875/2014</b>
<b>Franklin, Helen Johanna;</b> 02-02C, Women's cycling jersey/sports top, 06 May 2014	<b>12172/2014</b>	<b>Inventio AG;</b> 12-05, Travelator, (CH, 16 Jan 2014) 06 May 2014	<b>12162/2014</b>
<b>Fujitsu Limited;</b> 14-02, Arithmetic and control unit, (JP, 16 Oct 2013) 11 Apr 2014	<b>11805/2014</b>	<b>Inventio AG;</b> 12-05, Travelator, (CH, 16 Jan 2014) 06 May 2014	<b>12165/2014</b>
<b>Geberit International AG;</b> 23-02C, Control panels for toilets and/or urinals, (EM, 17 Jan 2014) 14 Apr 2014	<b>11846/2014</b>	<b>Inventio AG;</b> 12-05, Travelator, (CH, 16 Jan 2014) 06 May 2014	<b>12163/2014</b>
<b>Geberit International AG;</b> 23-02C, Control panels for toilets and/or urinals, (EM, 17 Jan 2014) 14 Apr 2014	<b>11850/2014</b>	<b>Inventio AG;</b> 12-05, Travelator, (CH, 16 Jan 2014) 06 May 2014	<b>12164/2014</b>
<b>Gu, Yuliang;T-CAP INNOVATION PTY LTD;</b> 13-03D, Powerboard, 28 Apr 2014	<b>12012/2014</b>	<b>IDENTITY MARKETING PTY LTD;</b> 32-02, Postcode booklets, 29 Apr 2014	<b>12040/2014</b>
<b>GASTECH AUSTRALIA PTY LTD;</b> 10-05, Low ambiguity visual gas alarm for portables, 05 May 2014	<b>12152/2014</b>	<b>IVECO S.P.A.;</b> 12-08, External style of commercial vehicle, (EM, 06 Nov 2013) 30 Apr 2014	<b>12091/2014</b>
<b>GM Global Technology Operations LLC;</b> 12-16B, Vehicle spoiler, 29 Apr 2014	<b>12048/2014</b>	<b>Jorgenson-Watts Pty Ltd;</b> 25-01K, Extrusion, 28 Apr 2014	<b>12020/2014</b>
<b>GM Global Technology Operations LLC;</b> 12-16A, Vehicle wheel, 29 Apr 2014	<b>12047/2014</b>	<b>Joseph Joseph Limited;</b> 09-09, Garbage bin, (EM, 05 Nov 2013) 01 May 2014	<b>12117/2014</b>
<b>GOLD STAR HOLDINGS AUSTRALIA PTY LTD;</b> 12-16NES, Load support stabiliser pad, 02 May 2014	<b>12141/2014</b>	<b>Kind Consumer Limited;</b> 27-99, Refill container for a simulated cigarette, (EM, 28 Oct 2013) 28 Apr 2014	<b>12027/2014</b>
<b>Harris, Emma Louise;King, Daniel;</b> 03-01NES, Jewellery box, 11 Apr 2014	<b>11811/2014</b>		

<b>King, Daniel;Harris, Emma Louise;</b> 03-01NES, Jewellery box, 11 Apr 2014	<b>11811/2014</b>	<b>LSI Industries, Inc.;</b> 26-05D, Lighting, (Divisional of 11364/2014) 29 Apr 2014	<b>12042/2014</b>
<b>Kirkness, Neil William;</b> 12-06B, Catamaran, 01 May 2014	<b>12119/2014</b>	<b>LSI Industries, Inc.;</b> 26-05D, Lighting, (Divisional of 11364/2014) 29 Apr 2014	<b>12043/2014</b>
<b>Koehn, Ekkehard;</b> 03-03, 06-03NES, Side post umbrella with adjustable table, 01 May 2014	<b>12116/2014</b>	<b>LSI Industries, Inc.;</b> 26-05C, Lighting, (Divisional of 11363/2014) 28 Apr 2014	<b>12035/2014</b>
<b>Koninklijke Douwe Egberts B.V.;</b> 07-02L, Coffee machine, (EM, 06 Nov 2013) 30 Apr 2014	<b>12084/2014</b>	<b>LSI Industries, Inc.;</b> 26-05C, Lighting, (Divisional of 11364/2014) 29 Apr 2014	<b>12056/2014</b>
<b>KENWOOD LIMITED;</b> 07-02K, Electric Kettle, (EM, 15 Nov 2013) 29 Apr 2014	<b>12049/2014</b>	<b>LSI Industries, Inc.;</b> 26-05C, Lighting, (Divisional of 11363/2014) 28 Apr 2014	<b>12032/2014</b>
<b>KENWOOD LIMITED;</b> 31-00, Electric blender, (EM, 29 Nov 2013) 07 May 2014	<b>12175/2014</b>	<b>LSI Industries, Inc.;</b> 26-05C, Lighting, (Divisional of 11363/2014) 28 Apr 2014	<b>12033/2014</b>
<b>KENWOOD LIMITED;</b> 07-02L, Coffee maker, (EM, 21 Nov 2013) 29 Apr 2014	<b>12050/2014</b>	<b>LSI Industries, Inc.;</b> 26-05C, Lighting, (Divisional of 11363/2014) 28 Apr 2014	<b>12034/2014</b>
<b>Lake, Dylan James;</b> 25-03, Post box, 28 Apr 2014	<b>12013/2014</b>	<b>LSI Industries, Inc.;</b> 26-05C, Lighting, (Divisional of 11363/2014) 28 Apr 2014	<b>12026/2014</b>
<b>Lake, Dylan James;</b> 25-03, Post box, 28 Apr 2014	<b>12014/2014</b>	<b>MacNeil IP LLC;</b> 12-16K, Cargo organizer, (US, 01 Nov 2013) 29 Apr 2014	<b>12037/2014</b>
<b>Lake, Dylan James;</b> 25-03, Post box, 28 Apr 2014	<b>12015/2014</b>	<b>McCain Foods Limited;</b> 01-02, Root vegetable product, (Divisional of 10420/2014) 29 Apr 2014	<b>12059/2014</b>
<b>Leibovich, Aaron;</b> 14-03A, Passive EM antennae for android smart phones, 08 May 2014	<b>12221/2014</b>	<b>Medline Industries, Inc.;</b> 24-01, Guide wire bowl, (US, 08 Nov 2013) 02 May 2014	<b>12120/2014</b>
<b>Leibovich, Aaron;</b> 14-03A, A passive EM antenna for iPhones, 08 May 2014	<b>12222/2014</b>	<b>Michelin Recherche et Technique S.A.;Compagnie Generale Des Etablissements Michelin;</b> 12-15C, A tyre, (US, 25 Nov 2013) 29 Apr 2014	<b>12039/2014</b>
<b>Lifetime Products, Inc.;</b> 06-01H, Chair, (Divisional of 10477/2014) 01 May 2014	<b>12111/2014</b>	<b>Michelin Recherche et Technique S.A.;Compagnie Generale Des Etablissements Michelin;</b> 12-15A, A tyre, (FR, 15 Nov 2013) 28 Apr 2014	<b>12028/2014</b>
<b>Littlebigsound Pte Ltd;</b> 14-01, Speaker, 28 Apr 2014	<b>12021/2014</b>	<b>Michelin Recherche Et Technique S.A.;Compagnie Generale Des Establissements Michelin;</b> 12-15B, A tyre, (FR, 25 Oct 2013) 11 Apr 2014	<b>11809/2014</b>
<b>Lupin Limited;</b> 24-04, Part of inhaler, (IN, 20 Feb 2014) 06 May 2014	<b>12161/2014</b>	<b>Minh, Dong Sig;Norton, Mathew Raymund;</b> 08-05N, Floor grinder abrasive shoe, 29 Apr 2014	<b>12062/2014</b>
<b>LED Technologies Pty Ltd;</b> 26-05E, Lighting assembly, 07 May 2014	<b>12182/2014</b>	<b>Mining Innovations Australia Pty Ltd;</b> 15-04, Excavator tooth, 15 Apr 2014	<b>11877/2014</b>
<b>LSI Industries, Inc.;</b> 26-05C, Lighting, (Divisional of 11363/2014) 28 Apr 2014	<b>12029/2014</b>	<b>Multisteps Pty Ltd;</b> 09-03F, A produce container, 08 May 2014	<b>12220/2014</b>
<b>LSI Industries, Inc.;</b> 26-05D, Lighting, (Divisional of 11364/2014) 29 Apr 2014	<b>12041/2014</b>		
<b>LSI Industries, Inc.;</b> 26-05D, Lighting, (Divisional of 11364/2014) 29 Apr 2014	<b>12044/2014</b>		
<b>LSI Industries, Inc.;</b> 26-05D, Lighting, (Divisional of 11364/2014) 29 Apr 2014	<b>12045/2014</b>		

<b>Mulumudi, Suman K;Mulumudi, Mahesh S;</b> 03-01NES, Electronic device casing, (US, 15 Oct 2013) 14 Apr 2014	<b>11847/2014</b>	<b>OMEGA SA (OMEGA AG) (OMEGA LTD.);</b> 10-02, Wristwatch, (WO, 08 Nov 2013) 28 Apr 2014	<b>12023/2014</b>
<b>Mulumudi, Mahesh S;Mulumudi, Suman K;</b> 03-01NES, Electronic device casing, (US, 15 Oct 2013) 14 Apr 2014	<b>11847/2014</b>	<b>Paul, Jennifer;Thompson, Katherine;</b> 07-01NES, Cake carrier, 03 May 2014	<b>12142/2014</b>
<b>Mulumudi, Suman K;Mulumudi, Mahesh S;</b> 03-01NES, Electronic device casing, (US, 15 Oct 2013) 14 Apr 2014	<b>11848/2014</b>	<b>Phasem Group Pty Ltd;</b> 28-99, Vitamin supplements, 12 Apr 2014	<b>11812/2014</b>
<b>Mulumudi, Mahesh S;Mulumudi, Suman K;</b> 03-01NES, Electronic device casing, (US, 15 Oct 2013) 14 Apr 2014	<b>11848/2014</b>	<b>Pridham, Andrew;</b> 08-08L, A roof anchor swivel bracket, 07 May 2014	<b>12177/2014</b>
<b>Mulumudi, Suman K;Mulumudi, Mahesh S;</b> 03-01NES, Electronic device casing, (US, 15 Oct 2013) 14 Apr 2014	<b>11849/2014</b>	<b>Pridham, Andrew;</b> 08-08L, A roof anchor swivel bracket, 07 May 2014	<b>12178/2014</b>
<b>Mulumudi, Mahesh S;Mulumudi, Suman K;</b> 03-01NES, Electronic device casing, (US, 15 Oct 2013) 14 Apr 2014	<b>11849/2014</b>	<b>Pullar, Barry Francis;</b> 16-99, A compact 360 3D photography production booth, 08 May 2014	<b>12223/2014</b>
<b>My Clever Dog Pty Ltd;</b> 30-99, Animal toy, 28 Apr 2014	<b>12022/2014</b>	<b>Radio Systems Corporation;</b> 14-03NES, Handheld transceiver with display, (US, 13 Jan 2014) 29 Apr 2014	<b>12057/2014</b>
<b>MIL-SYSTEMS PTY LTD;</b> 13-02, Inverter, 30 Apr 2014	<b>12080/2014</b>	<b>Radio Systems Corporation;</b> 14-03NES, Handheld transmitter, (US, 13 Jan 2014) 29 Apr 2014	<b>12060/2014</b>
<b>Nicholas, Alistair;Ferguson, Greig;Faulkner, Luke;</b> 12-16L, A coupler, 30 Apr 2014	<b>12104/2014</b>	<b>ResMed Limited;</b> 09-99, Packaging, (US, 07 Nov 2013) 06 May 2014	<b>12169/2014</b>
<b>Nixon, Inc.;</b> 10-02, Wrist watch, (US, 29 Oct 2013) 29 Apr 2014	<b>12038/2014</b>	<b>ResMed Limited;</b> 24-01, Patient interface and/or components thereof, (Divisional of 10313/2014) 28 Apr 2014	<b>12064/2014</b>
<b>Norton, Mathew Raymund;Minh, Dong Sig;</b> 08-05N, Floor grinder abrasive shoe, 29 Apr 2014	<b>12062/2014</b>	<b>Rogers, Kenneth Colin;</b> 07-02E, Barbecue liner, 02 May 2014	<b>12139/2014</b>
<b>Nottage, Craig;</b> 06-04NES, Wine rack, 29 Apr 2014	<b>12061/2014</b>	<b>Rogers, Kenneth Colin;</b> 07-02E, Barbecue liner, 02 May 2014	<b>12140/2014</b>
<b>O'Connell, Alexander Gavan;</b> 06-01E, Stool, 29 Apr 2014	<b>12058/2014</b>	<b>RANDL Industries, Inc.;</b> 13-03C, Plaster ring with off-center aperture, (US, 06 Nov 2013) 02 May 2014	<b>12135/2014</b>
<b>Officina Meccanica F.LLI Carlo E Francesco Lamera S.n.c.;</b> 07-02L, Tamper base, (EM, 08 Nov 2013) 07 May 2014	<b>12186/2014</b>	<b>RANDL Industries, Inc.;</b> 13-03C, Plaster ring with wide flange, (US, 06 Nov 2013) 02 May 2014	<b>12129/2014</b>
<b>Olivar, Dante Ramel;</b> 13-03NES, Roller-type button for remote controllers, (PH, 05 Nov 2013) 05 May 2014	<b>12148/2014</b>	<b>RANDL Industries, Inc.;</b> 13-03C, Plaster ring with wide flange, (US, 06 Nov 2013) 02 May 2014	<b>12130/2014</b>
<b>Ontel Products Corporation;</b> 07-04, Spiral peeler, (US, 21 Nov 2013) 02 May 2014	<b>12137/2014</b>	<b>RANDL Industries, Inc.;</b> 13-03C, Plaster ring with wide flange, (US, 06 Nov 2013) 02 May 2014	<b>12128/2014</b>
<b>Oz Care Australia Pty Ltd;</b> 32-03, oZ Care cartoon design packaging design, 02 May 2014	<b>12138/2014</b>	<b>RANDL Industries, Inc.;</b> 13-03C, Plaster ring with wide flange, (US, 06 Nov 2013) 02 May 2014	<b>12131/2014</b>
		<b>RANDL Industries, Inc.;</b> 13-03C, Plaster ring with wide flange, (US, 06 Nov 2013) 02 May 2014	<b>12132/2014</b>
		<b>RANDL Industries, Inc.;</b> 13-03C, Plaster ring with off-center aperture, (US, 06 Nov 2013) 02 May 2014	<b>12136/2014</b>

<b>Samsonite IP Holdings S.a r.l.;</b> 03-01A, Luggage, (US, 15 Oct 2013) 14 Apr 2014	<b>11852/2014</b>	<b>Techtronic Floor Care Technology Limited;</b> 15-05, Surface cleaning apparatus, (EP, 01 Nov 2013) 30 Apr 2014	<b>12101/2014</b>
<b>Sanofi-Aventis Deutschland GmbH;</b> 24-01, Display for use with a pen type injection device, (EP, 02 Aug 2013) 24 Apr 2014	<b>12133/2014</b>	<b>Techtronic Floor Care Technology Limited;</b> 15-05, Surface cleaning apparatus, (EM, 01 Nov 2013) 30 Apr 2014	<b>12100/2014</b>
<b>Sanofi-Aventis Deutschland GmbH;</b> 10-04, 24-04, Blood glucose meter, (EP, 07 Aug 2013) (Divisional of 10556/2014) 01 May 2014	<b>12106/2014</b>	<b>Techtronic Floor Care Technology Limited;</b> 15-05, Surface cleaning apparatus, (EM, 01 Nov 2013) 30 Apr 2014	<b>12098/2014</b>
<b>Savant Systems LLC;</b> 13-03NES, Lamp module for a lighting control system, (US, 04 Nov 2013) 01 May 2014	<b>12113/2014</b>	<b>The Coca-Cola Company;</b> 09-01K, Bottle, (JP, 06 Nov 2013) 05 May 2014	<b>12153/2014</b>
<b>Stryker Corporation;</b> 24-01, Line management device, (Divisional of 10459/2014) 01 May 2014	<b>12105/2014</b>	<b>The Gillette Company;</b> 28-03A, Razor cartridge, (US, 13 Nov 2013) 01 May 2014	<b>12112/2014</b>
<b>SAVERGLASS;</b> 09-01H, Bottle, (EM, 25 Nov 2013) 29 Apr 2014	<b>12051/2014</b>	<b>The Yokohama Rubber Co., Ltd.;</b> 12-15A, Tyre, (JP, 18 Oct 2013) 14 Apr 2014	<b>11851/2014</b>
<b>SAVERGLASS;</b> 09-01H, Bottle, (EM, 25 Nov 2013) 29 Apr 2014	<b>12054/2014</b>	<b>The Yokohama Rubber Co., Ltd.;</b> 12-15A, Tyre, (JP, 18 Oct 2013) 14 Apr 2014	<b>11844/2014</b>
<b>SAVERGLASS;</b> 09-01H, Bottle, (EM, 25 Nov 2013) 29 Apr 2014	<b>12052/2014</b>	<b>Thompson, Katherine;Paul, Jennifer;</b> 07-01NES, Cake carrier, 03 May 2014	<b>12142/2014</b>
<b>SAVERGLASS;</b> 09-01H, Bottle, (EM, 25 Nov 2013) 29 Apr 2014	<b>12053/2014</b>	<b>Transquip;</b> 15-09, Shield trench shoring device, (NZ, 19 Dec 2013) 30 Apr 2014	<b>12089/2014</b>
<b>SHOP VAC CORPORATION;</b> 15-05, Vacuum cleaner, (US, 11 Oct 2013) 11 Apr 2014	<b>11806/2014</b>	<b>Transquip;</b> 25-01K, Extrusion for a shield panel, (NZ, 19 Dec 2013) 30 Apr 2014	<b>12090/2014</b>
<b>SLINGTHINGS PTY. LTD.;Foord, Renee;</b> 03-99, A baby carrier that slips on like a t-shirt, 30 Apr 2014	<b>12086/2014</b>	<b>TriMas Corporation Pty Ltd;</b> 12-16M, Mechanical brake calliper, 07 May 2014	<b>12188/2014</b>
<b>SMEG S.p.A.;</b> 07-02F, Domestic appliance, (EM, 11 Oct 2013) 11 Apr 2014	<b>11807/2014</b>	<b>Tyco Fire Products LP;</b> 23-01A, Pipe fitting, (Divisional of 16623/2013) 07 May 2014	<b>12181/2014</b>
<b>SMEG S.p.A.;</b> 07-02F, Domestic appliance, (EM, 11 Oct 2013) 11 Apr 2014	<b>11808/2014</b>	<b>Umicore Building Products France;</b> 25-01NES, Zinc Building Element in the form of a sheet, slate or coil sheet, (EM, 29 Oct 2013) 29 Apr 2014	<b>12055/2014</b>
<b>SULO MGB Australia Pty Ltd;</b> 08-06, Handle protector, 06 May 2014	<b>12171/2014</b>	<b>Unilever PLC;</b> 09-01NES, Container, (EM, 11 Nov 2013) 30 Apr 2014	<b>12066/2014</b>
<b>T-CAP INNOVATION PTY LTD;Gu, Yuliang;</b> 13-03D, Powerboard, 28 Apr 2014	<b>12012/2014</b>	<b>Unilever PLC;</b> 09-01NES, Container, (EM, 11 Nov 2013) 30 Apr 2014	<b>12068/2014</b>
<b>Taylor, Simone;</b> 02-03, Shower cap/swim cap, 30 Apr 2014	<b>12102/2014</b>	<b>Unilever PLC;</b> 09-01NES, Container, (EM, 21 Mar 2014) 30 Apr 2014	<b>12069/2014</b>
<b>Techtronic Floor Care Technology Limited;</b> 15-05, Surface cleaning apparatus, (EM, 01 Nov 2013) 30 Apr 2014	<b>12099/2014</b>	<b>Unilever PLC;</b> 09-01NES, Container, (EM, 11 Nov 2013) 30 Apr 2014	<b>12067/2014</b>
		<b>Unilever PLC;</b> 09-07A, Cap, (EM, 11 Nov 2013) 30 Apr 2014	<b>12065/2014</b>

<b>USG Interiors, LLC;</b> 08-08NES, Cross tee with a hole locking tab, (US, 11 Nov 2013) 07 May 2014	<b>12179/2014</b>	<b>Who-Rae Pty Ltd;</b> 09-05, Packaging container for car floor mats, 02 May 2014	<b>12126/2014</b>
<b>UView Ultraviolet Systems Inc.;</b> 09-02B, 10-04, A container having two openings, (US, 04 Nov 2013) 02 May 2014	<b>12121/2014</b>	<b>Who-Rae Pty Ltd;</b> 09-05, Packaging container for car floor mats, 02 May 2014	<b>12123/2014</b>
<b>Walters, Mark William;Walters, Leasa Therese;</b> 21-02NES, Board, 06 May 2014	<b>12173/2014</b>	<b>Who-Rae Pty Ltd;</b> 09-05, Packaging container for car floor mats, 02 May 2014	<b>12124/2014</b>
<b>Walters, Leasa Therese;Walters, Mark William;</b> 21-02NES, Board, 06 May 2014	<b>12173/2014</b>	<b>Wilson, Lee;</b> 20-03NES, 20-03C, Public notice signage, 01 May 2014	<b>12107/2014</b>
<b>Water Tech LLC;</b> 08-05A, Leaf Vacuum, (US, 08 Nov 2013) 05 May 2014	<b>12149/2014</b>	<b>Wilson, Lee;</b> 20-03NES, 20-03C, Public notice signage, 28 Apr 2014	<b>12024/2014</b>
<b>Water Tech LLC;</b> 08-05A, Leaf vacuum (variable No. of impeller blades), (US, 08 Nov 2013) 05 May 2014	<b>12150/2014</b>	<b>Yongkang MRY Industry &amp; Trade Co., Ltd;</b> 28-03D, Hair clipper, 05 May 2014	<b>12154/2014</b>
<b>Werner Co;</b> 25-02C, Ladder handrail, 08 May 2014	<b>12217/2014</b>	<b>Yongkang MRY Industry &amp; Trade Co., Ltd;</b> 28-03D, Hair clipper, 05 May 2014	<b>12155/2014</b>
<b>Werner Co;</b> 25-04, Ladder platform, 08 May 2014	<b>12218/2014</b>	<b>Yongkang MRY Industry &amp; Trade Co., Ltd;</b> 28-03D, Hair clipper, 05 May 2014	<b>12156/2014</b>
<b>Whites Group Pty Ltd;</b> 11-02B, Plant pot, 06 May 2014	<b>12167/2014</b>	<b>Zevex, Inc.;</b> 30-03, Enteral feeding pump cassette, (US, 30 Nov 2013) 06 May 2014	<b>12159/2014</b>
<b>Whites Group Pty Ltd;</b> 11-02C, Bracket for holding a plant pot or the like, 06 May 2014	<b>12166/2014</b>	<b>Zevex, Inc.;</b> 30-03, Enteral feeding pump cassette, (US, 30 Nov 2013) 06 May 2014	<b>12160/2014</b>
<b>Who-Rae Pty Ltd;</b> 09-05, Packaging container for car floor mats, 02 May 2014	<b>12122/2014</b>	<b>Zurn Industries, LLC;</b> 23-01A, Plumbing fitting, (US, 30 Oct 2013) 14 Apr 2014	<b>11845/2014</b>
<b>Who-Rae Pty Ltd;</b> 09-05, Packaging container for car floor mats, 02 May 2014	<b>12127/2014</b>	<b>Zurn Industries, LLC.;</b> 23-02C, Urinal, (Divisional of 10939/2014) 07 May 2014	<b>12192/2014</b>
<b>Who-Rae Pty Ltd;</b> 09-05, Packaging container for car floor mats, 02 May 2014	<b>12125/2014</b>	<b>3M Innovative Properties Company;</b> 16-06, Eyewear article having side shield retainers, (US, 31 Oct 2013) 28 Apr 2014	<b>12025/2014</b>
		<b>3M Innovative Properties Company;</b> 29-02, Hearing protector, (US, 28 Oct 2013) 28 Apr 2014	<b>12017/2014</b>

**Applications Withdrawn**

10055 / 2014 (03-01A)	10056 / 2014 (03-01A)
10057 / 2014 (03-01A)	10058 / 2014 (03-01A)
10059 / 2014 (03-01A)	10060 / 2014 (03-01A)

**Applications Lapsed**

10624 / 2013 (08-09)

11903 / 2013 (06-13B)	10778 / 2013 (99-00)
12386 / 2013 (13-02)	11904 / 2013 (19-06)
16843 / 2013 (07-01NES)	12437 / 2013 (25-01G)
10031 / 2014 (14-02)	10023 / 2014 (05-02)
10116 / 2014 (02-07D)	10109 / 2014 (32-03)
10124 / 2014 (06-11)	10117 / 2014 (02-07D)
10126 / 2014 (06-11)	10125 / 2014 (06-11)
10131 / 2014 (06-01D)	10127 / 2014 (06-11)
10290 / 2014 (11-02B)	10280 / 2014 (02-01B)
10369 / 2014 (14-02)	10360 / 2014 (32-02)
10439 / 2014 (08-05E)	10376 / 2014 (32-02)
10493 / 2014 (12-16NES)	10446 / 2014 (07-05D)
10624 / 2014 (28-03NES)	10548 / 2014 (08-06)

**Extension of Period of Registration of Designs**

322281	324927	324928
324929	325978	325982
326000	326175	326198
326199	326200	326212
326213	326226	326227
326228	326229	326230
326231	326244	326245
326259	326260	326261
326262	326307	326314
326329	326373	326374
326426	326427	326461
326549	326550	326555
326582	326598	326601
326619	326652	326681
326687	326702	326747
326748	326825	326827
326828	326829	326830
326851	326856	326857
326903	326904	326930
326974	327021	327022
327027	327040	327041
327042	327043	327044
327045	327046	327047
327074	327173	327275
327547	328724	

**Revocation of Design Registrations**

The following Design Registration(s) have been revoked and are taken never to have been registered:

338258	15-07
338260	15-07
339334	12-12

**Registrations Ceased**

323195	323196	323228
323250	323252	323253
323263	323264	323265
323266	323269	323291
323292	323293	323294
323295	323296	323297
323298	323299	323312
323324	323325	323330
323331	323333	323334
323336	323337	323338
323339	323340	323352
323353	323354	323355
323356	323357	323359

323369	323371	323372
323455	323473	323474
323475	323511	323531
323534	323535	323563
323567	323632	323667
323668	323669	323670
323773	324047	324048
324277	324289	324411
324412	324413	324414
324469	324508	324509
324521	324522	324523
324524	324525	324526
324660	324778	325106
325107	325108	325109
325110	325111	325515
325946	326690	326691
349419	349959	

**Applications for Extension of time under Section 137**

Applications under section 137 for extension of time have been lodged. Objections must be lodged within 1 month from the date of this journal.

16605/2013 **Ningbo Ledeshi Electric Equipment Co. Limited**  
Address for Service: James & Wells Private Bag 3140 Hamilton  
NEW ZEALAND

16606/2013 **Ningbo Ledeshi Electric Equipment Co. Limited**  
Address for Service: James & Wells Private Bag 3140 Hamilton  
NEW ZEALAND

**Extensions of time granted under Section 137**

Applications lodged under section 137 for extension of time have been granted.

345566 **PAFtec Technologies Pty Ltd**

15057/2013 **Sturdybilt Agencies Pty Ltd**

355273 **S. C. Johnson & Son, Inc.**

355274 **Bruno Daeseleire**

**Names Registered - Alterations and Amendments**

(The name in parentheses is that of the subsequent applicant)

341972	( <b>Constar International LLC a Delaware Limited Liability company</b> ) Constar International Inc
341973	( <b>Constar International LLC a Delaware Limited Liability company</b> ) Constar International Inc
341974	( <b>Constar International LLC a Delaware Limited Liability company</b> ) Constar International Inc
355210	( <b>Chervon (HK) Limited</b> ) Chevron (HK) Limited
344651	( <b>Home Grown Brands Australia Pty Ltd</b> ) Land & Sea Sports Pty Ltd
329690	( <b>USG BORAL BUILDING PRODUCTS PTY LIMITED</b> ) Boral Australian Gypsum Limited

329689 ( **USG BORAL BUILDING PRODUCTS PTY LIMITED** ) Boral Australian Gypsum Limited  
 302765 ( **USG BORAL BUILDING PRODUCTS PTY LIMITED** ) Boral Australian Gypsum Limited  
 302764 ( **USG BORAL BUILDING PRODUCTS PTY LIMITED** ) Boral Australian Gypsum Limited  
 302763 ( **USG BORAL BUILDING PRODUCTS PTY LIMITED** ) Boral Australian Gypsum Limited  
 302762 ( **USG BORAL BUILDING PRODUCTS PTY LIMITED** ) Boral Australian Gypsum Limited  
 326865 ( **CUB Pty Ltd** ) Foster's Australia Limited  
 326895 ( **CUB Pty Ltd** ) Foster's Australia Limited

**Certificate(s) of Examination**

Examination of the following Design Registration(s) has been completed. Infringement proceedings may now be commenced.

300493	13-03D	09/05/2014
321863	25-02NES	05/05/2014
333991	09-07C	01/05/2014
345427	25-01D	09/05/2014
345428	25-01D	09/05/2014
345429	25-01D	09/05/2014
345430	25-01D	09/05/2014
345431	25-01D	09/05/2014
345432	25-01D	09/05/2014
345433	25-01D	09/05/2014
345434	25-01D	09/05/2014
345435	25-01D	09/05/2014
345436	25-01D	09/05/2014
348377	08-07	03/05/2014
348816	08-05H	02/05/2014
348967	20-02A	03/05/2014
349307	20-02A	03/05/2014
349564	14-03NES	09/05/2014
349565	14-03NES	09/05/2014
350299	08-05N	30/04/2014
350300	08-05N	30/04/2014
350498	08-01	11/05/2014
350499	08-01	12/05/2014
350501	08-01	11/05/2014
350502	08-01	12/05/2014
350504	08-01	12/05/2014
350530	10-04	08/05/2014
350532	23-01NES	05/05/2014
350553	07-01F	08/05/2014
350962	15-05	11/05/2014
350963	15-05	11/05/2014
351450	09-07B	08/05/2014
351819	19-99	30/04/2014
351820	19-99	30/04/2014
351822	19-99	30/04/2014
351845	19-99	30/04/2014
351854	09-01G	30/04/2014
351862	09-01G	30/04/2014
351931	09-01H	09/05/2014
351936	09-01H	09/05/2014
351937	09-01H	09/05/2014
352034	30-02	08/05/2014
352374	24-02	07/05/2014
352375	24-02	07/05/2014
352415	02-02NES	09/05/2014
352717	26-05E	09/05/2014
352777	25-02E	08/05/2014
352780	15-07	02/05/2014
353172	04-01	08/05/2014
354325	31-00	30/04/2014

**Publication and Registration Proceedings**

**Designs Registered**

This section provides a concordance between design number and registration number of Designs covered in this journal. It also shows the main class and registration date.

This section covers Registration numbers 355178 to 355315 .

The registration number shown below should be used in all future correspondence.

<b>Design Number</b>	<b>Registration Number</b>	<b>International Classification Code (IDC)</b>	<b>Registration Date</b>	<b>Design Number</b>	<b>Registration Number</b>	<b>International Classification Code (IDC)</b>	<b>Registration Date</b>
13370/2013	355178	11-01D	01/05/2014	11378/2014	355261	23-01D	05/05/2014
16258/2013	355179	25-02NES	01/05/2014	11387/2014	355200	23-01A	01/05/2014
16557/2013	355273	22-06	05/05/2014	11411/2014	355218	25-02H	02/05/2014
10016/2014	355274	06-09	05/05/2014	11429/2014	355275	20-02E	05/05/2014
10081/2014	355283	11-02B	06/05/2014	11483/2014	355192	06-01G	01/05/2014
10085/2014	355284	28-03B	06/05/2014	11497/2014	355294	09-01G	06/05/2014
10129/2014	355193	24-02	01/05/2014	11575/2014	355297	08-01	06/05/2014
10134/2014	355233	24-02	02/05/2014	11604/2014	355201	12-15B	01/05/2014
10142/2014	355194	24-02	01/05/2014	11605/2014	355202	12-15B	01/05/2014
10174/2014	355195	09-01A	01/05/2014	11613/2014	355262	09-04	05/05/2014
10186/2014	355180	10-04	01/05/2014	11678/2014	355203	24-04	01/05/2014
10191/2014	355285	26-06	06/05/2014	11682/2014	355204	24-04	02/05/2014
10195/2014	355286	14-03B	06/05/2014	11686/2014	355205	12-15C	02/05/2014
10255/2014	355257	24-04	05/05/2014	11687/2014	355206	05-05B	02/05/2014
10259/2014	355196	16-06	01/05/2014	11688/2014	355207	19-08	02/05/2014
10279/2014	355197	16-06	01/05/2014	11689/2014	355208	12-15A	02/05/2014
10320/2014	355234	23-03H	02/05/2014	11690/2014	355209	28-03A	02/05/2014
10384/2014	355181	20-02E	01/05/2014	11692/2014	355210	08-03	02/05/2014
10385/2014	355182	20-02E	01/05/2014	11693/2014	355211	08-03	02/05/2014
10386/2014	355183	20-02E	01/05/2014	11694/2014	355212	09-01NES	02/05/2014
10397/2014	355287	02-04NES	06/05/2014	11695/2014	355213	24-02	02/05/2014
10461/2014	355184	14-02	01/05/2014	11696/2014	355214	23-01B	02/05/2014
10462/2014	355235	08-05NES	02/05/2014	11698/2014	355237	09-01F	02/05/2014
10573/2014	355215	02-02NES	02/05/2014	11699/2014	355238	24-01	02/05/2014
10696/2014	355185	06-01H	01/05/2014	11703/2014	355239	12-15B	02/05/2014
10697/2014	355288	06-01H	06/05/2014	11704/2014	355240	30-99	02/05/2014
10838/2014	355198	08-08G	01/05/2014	11705/2014	355241	12-15B	02/05/2014
10906/2014	355219	16-06	02/05/2014	11706/2014	355242	02-02C	02/05/2014
10908/2014	355220	16-06	02/05/2014	11707/2014	355243	02-02C	02/05/2014
10913/2014	355221	16-06	02/05/2014	11708/2014	355223	02-02NES	02/05/2014
10923/2014	355236	14-01	02/05/2014	11709/2014	355224	02-02NES	02/05/2014
10926/2014	355222	16-06	02/05/2014	11710/2014	355225	02-02C	02/05/2014
10954/2014	355186	25-01K	01/05/2014	11711/2014	355226	02-02C	02/05/2014
10990/2014	355216	26-05E	02/05/2014	11713/2014	355227	02-02C	02/05/2014
11017/2014	355187	25-02C	01/05/2014	11714/2014	355228	02-02C	02/05/2014
11059/2014	355217	12-16B	02/05/2014	11715/2014	355229	02-02C	02/05/2014
11088/2014	355296	03-01D	06/05/2014	11716/2014	355230	02-02NES	02/05/2014
11089/2014	355289	07-99C	06/05/2014	11717/2014	355231	02-02NES	02/05/2014
11090/2014	355290	07-99C	06/05/2014	11718/2014	355232	02-04B	02/05/2014
11091/2014	355291	07-99C	06/05/2014	11719/2014	355244	12-15B	02/05/2014
11092/2014	355258	07-99C	05/05/2014	11721/2014	355245	24-04	02/05/2014
11110/2014	355259	26-05D	05/05/2014	11722/2014	355246	12-15B	02/05/2014
11111/2014	355260	26-05D	05/05/2014	11724/2014	355247	24-04	02/05/2014
11179/2014	355188	03-01B	01/05/2014	11729/2014	355248	24-04	02/05/2014
11199/2014	355199	08-05F	01/05/2014	11731/2014	355249	24-04	02/05/2014
11243/2014	355189	09-07C	01/05/2014	11733/2014	355250	14-02	02/05/2014
11279/2014	355190	30-02	01/05/2014	11734/2014	355251	14-02	02/05/2014
11327/2014	355191	08-01	01/05/2014	11735/2014	355252	14-02	02/05/2014
11363/2014	355292	26-05D	06/05/2014	11737/2014	355253	05-06NES	02/05/2014
11364/2014	355293	26-05D	06/05/2014	11738/2014	355254	05-06NES	02/05/2014

Publication and Registration Proceedings - Designs Registered cont'd

Design Number	Registration Number	International Classification Code (IDC)	Registration Date	Design Number	Registration Number	International Classification Code (IDC)	Registration Date
11739/2014	355255	12-16H	02/05/2014	11785/2014	355298	15-05	06/05/2014
11740/2014	355256	12-16H	02/05/2014	11786/2014	355299	15-05	06/05/2014
11749/2014	355295	24-02	06/05/2014	11787/2014	355300	13-02	06/05/2014
11758/2014	355276	15-07	05/05/2014	11788/2014	355301	15-05	06/05/2014
11759/2014	355277	15-07	05/05/2014	11790/2014	355302	06-04NES	06/05/2014
11760/2014	355278	25-03	05/05/2014	11791/2014	355303	20-03C	06/05/2014
11761/2014	355279	08-05NES	05/05/2014	11792/2014	355304	07-01B	06/05/2014
11762/2014	355280	08-05P	05/05/2014	11793/2014	355305	26-02	06/05/2014
11763/2014	355281	08-05L	05/05/2014	11794/2014	355306	08-05L	06/05/2014
11765/2014	355282	08-05L	05/05/2014	11796/2014	355307	21-02C	06/05/2014
11768/2014	355263	02-04NES	05/05/2014	11797/2014	355308	09-03A	06/05/2014
11770/2014	355264	02-03	05/05/2014	11798/2014	355309	09-03A	06/05/2014
11771/2014	355265	25-01C	05/05/2014	11799/2014	355310	04-01	06/05/2014
11773/2014	355266	02-04NES	05/05/2014	11801/2014	355311	04-01	06/05/2014
11778/2014	355267	06-13B	05/05/2014	11802/2014	355312	12-15C	06/05/2014
11779/2014	355268	15-05	05/05/2014	11803/2014	355313	12-15B	06/05/2014
11780/2014	355269	15-05	05/05/2014	11804/2014	355314	31-00	06/05/2014
11781/2014	355270	15-05	05/05/2014	11805/2014	355315	14-02	06/05/2014
11782/2014	355271	15-05	05/05/2014				
11783/2014	355272	15-05	05/05/2014				

**Publication and Registration Proceedings**

**Class Listing of Designs Published or Registered**

The following section shows an International Classification Code listing of the Registered or Published Designs covered in this supplement.

<b>Classification</b>	<b>Registration Number</b>	<b>Design Number</b>	<b>Classification</b>	<b>Registration Number</b>	<b>Design Number</b>
02-02C	355225	11710/2014	09-01NES	355212	11694/2014
02-02C	355226	11711/2014	09-03A	355308	11797/2014
02-02C	355227	11713/2014	09-03A	355309	11798/2014
02-02C	355228	11714/2014	09-03M	355308	11797/2014
02-02C	355229	11715/2014	09-03M	355309	11798/2014
02-02C	355242	11706/2014	09-04	355262	11613/2014
02-02C	355243	11707/2014	09-07C	355189	11243/2014
02-02NES	355215	10573/2014	10-04	355180	10186/2014
02-02NES	355223	11708/2014	11-01D	355178	13370/2013
02-02NES	355224	11709/2014	11-02B	355283	10081/2014
02-02NES	355230	11716/2014	12-15A	355208	11689/2014
02-02NES	355231	11717/2014	12-15B	355201	11604/2014
02-03	355264	11770/2014	12-15B	355202	11605/2014
02-04B	355232	11718/2014	12-15B	355239	11703/2014
02-04NES	355263	11768/2014	12-15B	355241	11705/2014
02-04NES	355266	11773/2014	12-15B	355244	11719/2014
02-04NES	355287	10397/2014	12-15B	355246	11722/2014
03-01B	355188	11179/2014	12-15B	355313	11803/2014
03-01D	355296	11088/2014	12-15C	355205	11686/2014
04-01	355310	11799/2014	12-15C	355312	11802/2014
04-01	355311	11801/2014	12-16B	355217	11059/2014
05-05B	355206	11687/2014	12-16H	355255	11739/2014
05-06NES	355253	11737/2014	12-16H	355256	11740/2014
05-06NES	355254	11738/2014	13-02	355285	10191/2014
06-01G	355192	11483/2014	13-02	355300	11787/2014
06-01H	355185	10696/2014	13-03NES	355300	11787/2014
06-01H	355288	10697/2014	14-01	355236	10923/2014
06-04NES	355302	11790/2014	14-02	355184	10461/2014
06-09	355267	11778/2014	14-02	355236	10923/2014
06-09	355274	10016/2014	14-02	355250	11733/2014
06-13B	355267	11778/2014	14-02	355251	11734/2014
07-01B	355304	11792/2014	14-02	355252	11735/2014
07-99C	355258	11092/2014	14-02	355315	11805/2014
07-99C	355289	11089/2014	14-03B	355286	10195/2014
07-99C	355290	11090/2014	15-05	355268	11779/2014
07-99C	355291	11091/2014	15-05	355269	11780/2014
08-01	355191	11327/2014	15-05	355270	11781/2014
08-01	355297	11575/2014	15-05	355271	11782/2014
08-03	355210	11692/2014	15-05	355272	11783/2014
08-03	355211	11693/2014	15-05	355298	11785/2014
08-05F	355199	11199/2014	15-05	355299	11786/2014
08-05L	355281	11763/2014	15-05	355301	11788/2014
08-05L	355282	11765/2014	15-07	355276	11758/2014
08-05L	355306	11794/2014	15-07	355277	11759/2014
08-05NES	355235	10462/2014	16-06	355196	10259/2014
08-05NES	355279	11761/2014	16-06	355197	10279/2014
08-05P	355280	11762/2014	16-06	355219	10906/2014
08-08G	355198	10838/2014	16-06	355220	10908/2014
08-08NES	355191	11327/2014	16-06	355221	10913/2014
08-09	355179	16258/2013	16-06	355222	10926/2014
09-01A	355195	10174/2014	19-08	355207	11688/2014
09-01F	355237	11698/2014	20-02E	355181	10384/2014
09-01G	355294	11497/2014	20-02E	355182	10385/2014

Registration Proceedings - Class Listing of Designs Published or Registered cont'd

Classification	Registration Number	Design Number	Classification	Registration Number	Design Number
20-02E	355183	10386/2014	24-04	355257	10255/2014
20-02E	355275	11429/2014	25-01C	355265	11771/2014
20-03C	355303	11791/2014	25-01K	355186	10954/2014
20-03NES	355303	11791/2014	25-02C	355187	11017/2014
21-02C	355307	11796/2014	25-02H	355218	11411/2014
22-06	355273	16557/2013	25-02NES	355179	16258/2013
23-01A	355200	11387/2014	25-03	355278	11760/2014
23-01B	355214	11696/2014	26-02	355305	11793/2014
23-01D	355261	11378/2014	26-05D	355259	11110/2014
23-03H	355234	10320/2014	26-05D	355260	11111/2014
24-01	355238	11699/2014	26-05D	355292	11363/2014
24-02	355193	10129/2014	26-05D	355293	11364/2014
24-02	355194	10142/2014	26-05E	355216	10990/2014
24-02	355213	11695/2014	26-06	355285	10191/2014
24-02	355233	10134/2014	28-03A	355209	11690/2014
24-02	355295	11749/2014	28-03B	355284	10085/2014
24-04	355203	11678/2014	30-02	355190	11279/2014
24-04	355204	11682/2014	30-99	355240	11704/2014
24-04	355245	11721/2014	31-00	355314	11804/2014
24-04	355247	11724/2014	32-03	355195	10174/2014
24-04	355248	11729/2014			
24-04	355249	11731/2014			

(21) Design Number: **13370/2013**  
(22) Date of Filing Application: **11 July 2013**  
(24) Date from which industrial property rights may have effect: **11 July 2013**  
(54) Product in respect of which the design is registered: **Earring**  
(51) International Design Classification: **11-01D**  
(74) Name(s) of Attorney(s): **Callinans**  
(71) Name(s) and Address(s) of Applicant(s):

**Bulgari S.p.A.**  
**Lungotevere Marzio 11 I-00186 Rome Italy**

(72) Name(s) of Designer(s): **Paolo Bulgari**

(45) Registration Date: **01 May 2014**

(30) Convention priority data:

(31) Number	(32) Date	(33) Country
<b>713485701</b>	<b>11 Jan 2013</b>	<b>WORLD INTELLECTUAL PROPERTY ORGANIZATION (WIPO)</b>

(56) Related Art Documents: **Not Applicable**

(57) Statement of Newness and Distinctiveness: **Nil**



(21) Design Number: **16258/2013**  
(22) Date of Filing Application: **03 December 2013**  
(24) Date from which industrial property rights may have effect: **03 December 2013**  
(54) Product in respect of which the design is registered: **Molded plastic corflute door architrave protector**  
(51) International Design Classification: **25-02NES, 08-09**  
(74) Name(s) of Attorney(s):  
(71) Name(s) and Address(s) of Applicant(s):

**Ivica John Culina**  
**PO BOX 74 Essendon North VIC 3041 Australia**

(72) Name(s) of Designer(s): **Ivica John Culina**

(45) Registration Date: **01 May 2014**

(56) Related Art Documents: **Not Applicable**

(57) Statement of Newness and Distinctiveness: **The newness and distinctiveness of the product is evident in the plastic corflute's memory that allows the product to wrap around door architraves and hold for an indefinite amount of time - needing no further attachments or fittings. This and the distinctive universal pop-out 'hinge holes' mean that the product can be fitted to any sized architrave, oriented either to the left or to the right, with any sized or positioned hinge.**



(21) Design Number: **10186/2014**  
(22) Date of Filing Application: **16 January 2014**  
(24) Date from which industrial property rights may have effect: **16 January 2014**  
(54) Product in respect of which the design is registered: **Mouthpiece for breath testing**  
(51) International Design Classification: **10-04**  
(74) Name(s) of Attorney(s): **Griffith Hack**  
(71) Name(s) and Address(s) of Applicant(s):  
**QuinTron Instrument Company, Inc.**  
**2208 S. 38 Street Melwaukee Wisconsin, 53215 United States of America**  
(72) Name(s) of Designer(s): **Eric Lyle Hamilton**  
(45) Registration Date: **01 May 2014**  
(30) Convention priority data:  
(31) Number (32) Date (33) Country  
**29/460,968 17 Jul 2013 UNITED STATES OF AMERICA**  
(56) Related Art Documents: **Not Applicable**  
(57) Statement of Newness and Distinctiveness: **Newness and distinctiveness resides in the visual features, including the shape and configuration of the product shown in the representations. Those parts shown by dashed lines do not form part of the product and have been included for illustrative purposes only.**

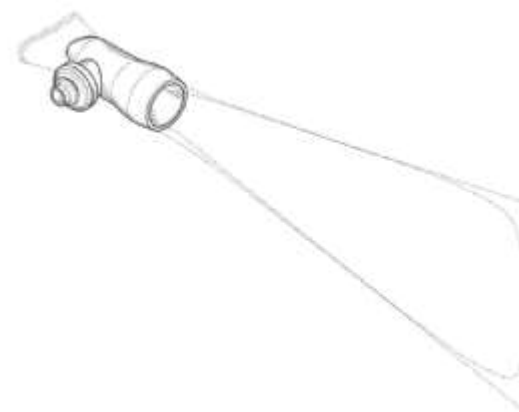

(21) Design Number: **10384/2014**  
(22) Date of Filing Application: **28 January 2014**  
(24) Date from which industrial property rights may have effect: **28 January 2014**  
(54) Product in respect of which the design is registered: **Item display rack**  
(51) International Design Classification: **20-02E**  
(74) Name(s) of Attorney(s): **PHILLIPS ORMONDE FITZPATRICK**  
(71) Name(s) and Address(s) of Applicant(s):  
**Holbox B.V.**  
**Loperweg 8 Echt 6101 AE The Netherlands**  
(72) Name(s) of Designer(s): **Johannes Martinez Hol**  
(45) Registration Date: **01 May 2014**  
(30) Convention priority data:  
(31) Number (32) Date (33) Country  
**JP2013-017155 26 Jul 2013 JAPAN**  
(56) Related Art Documents: **Not Applicable**  
(57) Statement of Newness and Distinctiveness: **Those features of the item display rack depicted in the representations that are new and distinctive are the shape and/or configuration and/or pattern and/or ornamentation. The items marked "A" shown in Figure 2 may or may not form part of the design. The graphics marked "B" shown in Figure 2 may or may not form part of the design.**

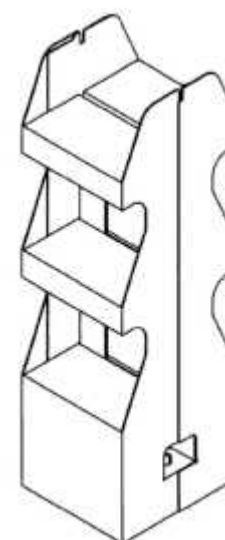

(21) Design Number: **10385/2014**  
(22) Date of Filing Application: **28 January 2014**  
(24) Date from which industrial property rights may have effect: **28 January 2014**  
(54) Product in respect of which the design is registered: **Item display rack**  
(51) International Design Classification: **20-02E**  
(74) Name(s) of Attorney(s): **PHILLIPS ORMONDE FITZPATRICK**  
(71) Name(s) and Address(s) of Applicant(s):

**Holbox B.V.**  
**Loperweg 8 Echt 6101 AE The Netherlands**

(72) Name(s) of Designer(s): **Johannes Martinez Hol**

(45) Registration Date: **01 May 2014**

(30) Convention priority data:

(31) Number	(32) Date	(33) Country
<b>JP2013-017157</b>	<b>26 Jul 2013</b>	<b>JAPAN</b>

(56) Related Art Documents: **Not Applicable**

(57) Statement of Newness and Distinctiveness: **Those features of the item display rack depicted in the representations that are new and distinctive are the shape and/or configuration and/or pattern and/or ornamentation. The items marked "A" shown in Figure 2 may or may not form part of the design. The graphics marked "B" shown in Figure 2 may or may not form part of the design.**

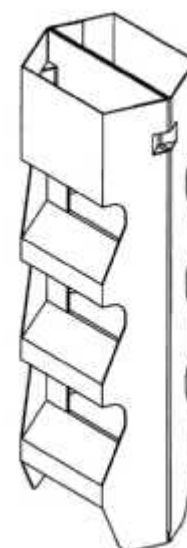

(21) Design Number: **10386/2014**  
(22) Date of Filing Application: **28 January 2014**  
(24) Date from which industrial property rights may have effect: **28 January 2014**  
(54) Product in respect of which the design is registered: **Item display rack**  
(51) International Design Classification: **20-02E**  
(74) Name(s) of Attorney(s): **PHILLIPS ORMONDE FITZPATRICK**  
(71) Name(s) and Address(s) of Applicant(s):

**Holbox B.V.**  
**Loperweg 8 Echt 6101 AE The Netherlands**

(72) Name(s) of Designer(s): **Johannes Martinez Hol**

(45) Registration Date: **01 May 2014**

(30) Convention priority data:

(31) Number	(32) Date	(33) Country
<b>JP2013-017153</b>	<b>26 Jul 2013</b>	<b>JAPAN</b>

(56) Related Art Documents: **Not Applicable**

(57) Statement of Newness and Distinctiveness: **Those features of the item display rack depicted in the representations that are new and distinctive are the shape and/or configuration and/or pattern and/or ornamentation. The items marked "A" shown in Figure 2 may or may not form part of the design. The graphics marked "B" shown in Figure 2 may or may not form part of the design.**

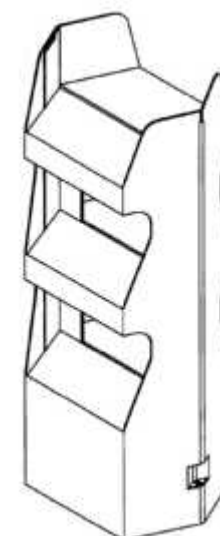

(21) Design Number: **10461/2014**  
(22) Date of Filing Application: **31 January 2014**  
(24) Date from which industrial property rights may have effect: **31 January 2014**  
(54) Product in respect of which the design is registered: **Display screen**  
(51) International Design Classification: **14-02**  
(74) Name(s) of Attorney(s): **Davies Collison Cave**  
(71) Name(s) and Address(s) of Applicant(s):  
**Palantir Technologies, Inc.**  
**100 Hamilton Avenue Suite 300 Palo Alto California 94301 United States of America**

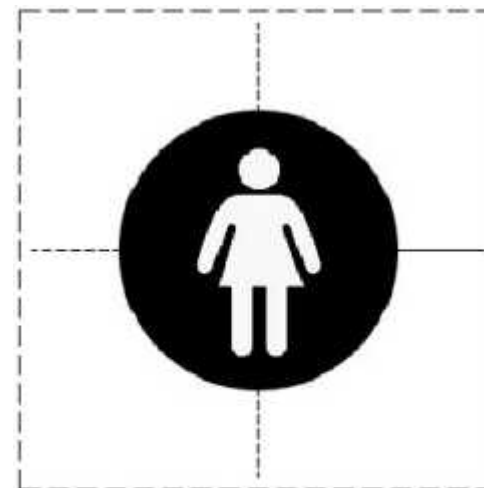

(72) Name(s) of Designer(s): **Joshua Goldenberg and Alvin Thong**  
(45) Registration Date: **01 May 2014**  
(30) Convention priority data:  
(31) Number (32) Date (33) Country  
**29/462,370 01 Aug 2013 UNITED STATES OF AMERICA**  
(56) Related Art Documents: **Not Applicable**  
(57) Statement of Newness and Distinctiveness: **Newness and distinctiveness is claimed in the visual features shown in the solid lines in the representations. In considering the extent of the design rights, the broken lines shown in the representations are for illustrative purposes only and do not form part of the design. The black of the circle and white of the icons represent contrasting colours, and are not limited to black and white, or white and black respectively. For example, the circle may be coloured red (rather than black, as shown), and the icons within the circle may be coloured green (rather than white, as shown). Any other colour combination is also contemplated.**

(21) Design Number: **10696/2014**  
(22) Date of Filing Application: **13 February 2014**  
(24) Date from which industrial property rights may have effect: **13 February 2014**  
(54) Product in respect of which the design is registered: **Chair**  
(51) International Design Classification: **06-01H**  
(74) Name(s) of Attorney(s): **Armour IP**  
(71) Name(s) and Address(s) of Applicant(s):  
**Tribu N.V.**  
**Langendijkstraat 5A Zutendaal 3690 Belgium**



(72) Name(s) of Designer(s): **Monica Armani**  
(45) Registration Date: **01 May 2014**  
(30) Convention priority data:  
(31) Number (32) Date (33) Country  
**002302323-0010 04 Sep 2013 OFFICE FOR HARMONISATION IN THE INTERNAL MARKET (OHIM)**  
(56) Related Art Documents: **Not Applicable**  
(57) Statement of Newness and Distinctiveness: **Nil**

(21) Design Number: **10954/2014**  
(22) Date of Filing Application: **03 March 2014**  
(24) Date from which industrial property rights may have effect: **03 March 2014**  
(54) Product in respect of which the design is registered: **Extrusion**  
(51) International Design Classification: **25-01K**  
(74) Name(s) of Attorney(s):  
(71) Name(s) and Address(s) of Applicant(s):  
**Jorgenson-Watts Pty Ltd**  
**L6 167 Queen St Melbourne VIC 3000 Australia**  
(72) Name(s) of Designer(s): **John Russell Watts**  
(45) Registration Date: **01 May 2014**  
(56) Related Art Documents: **Not Applicable**  
(57) Statement of Newness and Distinctiveness: **Nil**



(21) Design Number: **11017/2014**  
(22) Date of Filing Application: **05 March 2014**  
(24) Date from which industrial property rights may have effect: **05 March 2014**  
(54) Product in respect of which the design is registered: **Fence**  
(51) International Design Classification: **25-02C**  
(74) Name(s) of Attorney(s): **IP Service International**  
(71) Name(s) and Address(s) of Applicant(s):  
**Futurewood Pty Ltd**  
**8-9 Kelvin Ct Ringwood North VIC 3134 Australia**  
(72) Name(s) of Designer(s): **David Robert Elms and Gilbert John Major**  
(45) Registration Date: **01 May 2014**  
(56) Related Art Documents: **Not Applicable**  
(57) Statement of Newness and Distinctiveness: **Nil**



- (21) Design Number: **11179/2014**  
(22) Date of Filing Application: **13 March 2014**  
(24) Date from which industrial property rights may have effect: **23 August 2013**  
(54) Product in respect of which the design is registered: **Bag**  
(51) International Design Classification: **03-01B**  
(74) Name(s) of Attorney(s): **Allens Patent & Trade Mark Attorneys**  
(71) Name(s) and Address(s) of Applicant(s):  
**Forever New Clothing Pty Ltd**  
**714-716 High St Kew East VIC 3102 Australia**  
(72) Name(s) of Designer(s): **Georgia Roberts-Thomson**  
(45) Registration Date: **01 May 2014**  
(62) Divisional of: **354618**  
(56) Related Art Documents: **Not Applicable**  
(57) Statement of Newness and Distinctiveness: **Newness and distinctiveness resides in the visual features of shape, configuration, pattern and/or ornamentation of a bag as shown in the accompanying representation.**



- (21) Design Number: **11243/2014**  
(22) Date of Filing Application: **18 March 2014**  
(24) Date from which industrial property rights may have effect: **18 March 2014**  
(54) Product in respect of which the design is registered: **Cap**  
(51) International Design Classification: **09-07C**  
(74) Name(s) of Attorney(s): **Davies Collison Cave**  
(71) Name(s) and Address(s) of Applicant(s):  
**Cormack Packaging Pty Ltd**  
**26 Harley Cres Condell Park NSW 2200 Australia**  
(72) Name(s) of Designer(s): **Brad Stebbing**  
(45) Registration Date: **01 May 2014**  
(56) Related Art Documents: **Not Applicable**  
(57) Statement of Newness and Distinctiveness: **Nil**

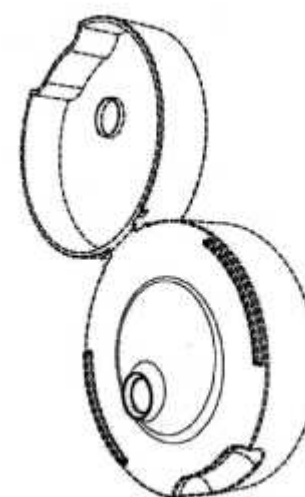

- (21) Design Number: **11279/2014**  
(22) Date of Filing Application: **19 March 2014**  
(24) Date from which industrial property rights may have effect: **19 March 2014**  
(54) Product in respect of which the design is registered: **A collapsible enclosure**  
(51) International Design Classification: **30-02**  
(74) Name(s) of Attorney(s):  
(71) Name(s) and Address(s) of Applicant(s):  
**Jamie Conroy**  
**273 Whitehall Rd Raceview QLD 4305 Australia**  
(72) Name(s) of Designer(s): **Michael Conroy**  
(45) Registration Date: **01 May 2014**  
(56) Related Art Documents: **Not Applicable**  
(57) Statement of Newness and Distinctiveness: **A length of rigid material with a recess in one end a bend in the opposite end a twist in between.**



- (21) Design Number: **11327/2014**  
(22) Date of Filing Application: **20 March 2014**  
(24) Date from which industrial property rights may have effect: **20 March 2014**  
(54) Product in respect of which the design is registered: **Drill rod support**  
(51) International Design Classification: **08-01, 08-08NES**  
(74) Name(s) of Attorney(s): **Armour IP**  
(71) Name(s) and Address(s) of Applicant(s):  
**Bend-tech Investments 1 Pty Ltd**  
**573 Bickley Rd Maddington WA 6109 Australia**  
(72) Name(s) of Designer(s): **Alan Bryant**  
(45) Registration Date: **01 May 2014**  
(56) Related Art Documents: **Not Applicable**  
(57) Statement of Newness and Distinctiveness: **Nil**

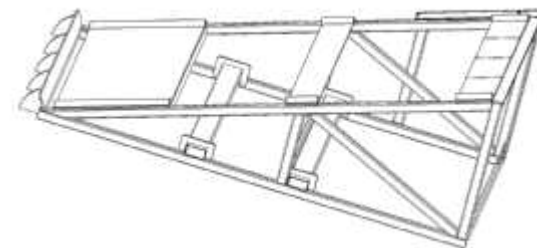

- (21) Design Number: **11483/2014**  
(22) Date of Filing Application: **27 March 2014**  
(24) Date from which industrial property rights may have effect: **27 March 2014**  
(54) Product in respect of which the design is registered: **A sofa**  
(51) International Design Classification: **06-01G**  
(74) Name(s) of Attorney(s): **FB Rice**  
(71) Name(s) and Address(s) of Applicant(s):  
**King Furniture Australia Pty Ltd**  
**123 Turrella St Turrella NSW 2205 Australia**  
(72) Name(s) of Designer(s): **David King and John Levey and Tanya Rechberger and Ryan Lawson and Anastasie Panagopoulos**  
(45) Registration Date: **01 May 2014**  
(56) Related Art Documents: **Not Applicable**  
(57) Statement of Newness and Distinctiveness: **Newness and distinctiveness reside in those features of the sofa excluding the features shown in yellow in the representations, it being understood that the yellow line demarcating the break indicates that the break is absent altogether or that the position of the break varies from the illustrated position. It is further to be understood that the armrest of the sofa may be on the opposite side of the base to that shown in the representations.**



- (21) Design Number: **10129/2014**  
(22) Date of Filing Application: **14 January 2014**  
(24) Date from which industrial property rights may have effect: **14 January 2014**  
(54) Product in respect of which the design is registered: **Injector**  
(51) International Design Classification: **24-02**  
(74) Name(s) of Attorney(s): **Davies Collison Cave**  
(71) Name(s) and Address(s) of Applicant(s):  
**Henke-Sass Wolf GmbH**  
**Keltenstrasse 1 Tuttlingen 78532 Germany**  
(72) Name(s) of Designer(s): **Melanie Eisele and Stefan Knefel**  
(45) Registration Date: **01 May 2014**  
(30) Convention priority data:  
(31) Number (32) Date (33) Country  
**002276147-0001 17 Jul 2013 OFFICE FOR HARMONISATION IN THE INTERNAL MARKET (OHIM)**  
(56) Related Art Documents: **Not Applicable**  
(57) Statement of Newness and Distinctiveness: **Nil**

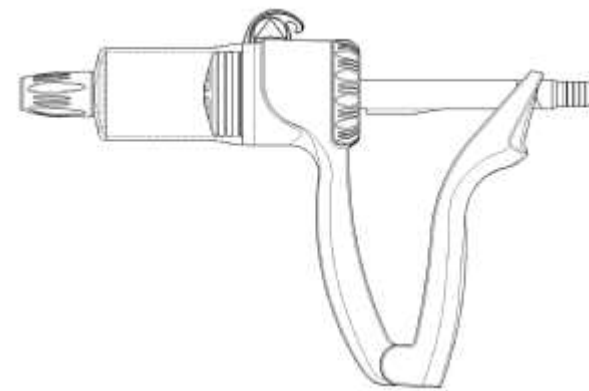

(21) Design Number: **10142/2014**  
(22) Date of Filing Application: **14 January 2014**  
(24) Date from which industrial property rights may have effect: **14 January 2014**  
(54) Product in respect of which the design is registered: **Hanging hook for an injector**  
(51) International Design Classification: **24-02**  
(74) Name(s) of Attorney(s): **Davies Collison Cave**  
(71) Name(s) and Address(s) of Applicant(s):  
**Henke-Sass Wolf GmbH**  
**Keltenstrasse 1 Tuttlingen 78532 Germany**  
(72) Name(s) of Designer(s): **Melanie Eisele and Stefan Knefel**  
(45) Registration Date: **01 May 2014**  
(30) Convention priority data:  
(31) Number (32) Date (33) Country  
**002276147-0003 17 Jul 2013 OFFICE FOR HARMONISATION IN THE INTERNAL MARKET (OHIM)**  
(56) Related Art Documents: **Not Applicable**  
(57) Statement of Newness and Distinctiveness: **Nil**

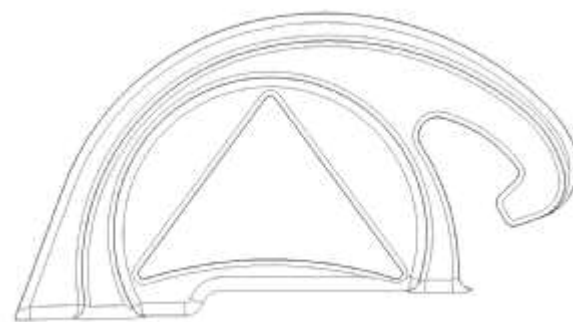

(21) Design Number: **10174/2014**  
(22) Date of Filing Application: **16 January 2014**  
(24) Date from which industrial property rights may have effect: **16 January 2014**  
(54) Product in respect of which the design is registered: **Spray dispenser with icon**  
(51) International Design Classification: **09-01A, 32-03**  
(74) Name(s) of Attorney(s): **SPRUSON & FERGUSON**  
(71) Name(s) and Address(s) of Applicant(s):  
**S. C. Johnson & Son, Inc.**  
**1525 Howe Street Racine Wisconsin 53403 United States of America**  
(72) Name(s) of Designer(s): **Danielle C. Giza**  
(45) Registration Date: **01 May 2014**  
(30) Convention priority data:  
(31) Number (32) Date (33) Country  
**29/461780 24 Jul 2013 UNITED STATES OF AMERICA**  
(56) Related Art Documents: **Not Applicable**  
(57) Statement of Newness and Distinctiveness: **Newness and distinctiveness is claimed in those features of pattern and/or ornamentation of a spray dispenser with icon illustrated in continuous lines in the accompanying representations.**

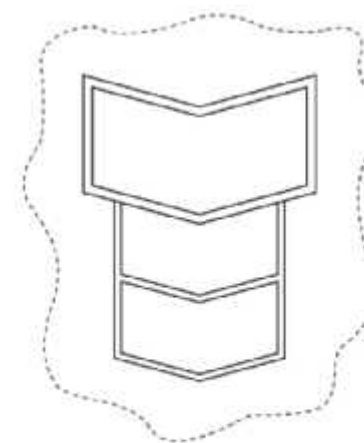

(21) Design Number: **10259/2014**  
(22) Date of Filing Application: **21 January 2014**  
(24) Date from which industrial property rights may have effect: **21 January 2014**  
(54) Product in respect of which the design is registered: **Eyeglass component**  
(51) International Design Classification: **16-06**  
(74) Name(s) of Attorney(s): **Davies Collison Cave**  
(71) Name(s) and Address(s) of Applicant(s):

**Oakley, Inc**  
**One Icon Foothill Ranch California 92610 United States of America**

(72) Name(s) of Designer(s): **Jae Shin**

(45) Registration Date: **01 May 2014**

(30) Convention priority data:

(31) Number	(32) Date	(33) Country
<b>29/471,271</b>	<b>30 Oct 2013</b>	<b>UNITED STATES OF AMERICA</b>

(56) Related Art Documents: **Not Applicable**

(57) Statement of Newness and Distinctiveness: **Newness and distinctiveness is claimed in the visual features shown in solid lines in the representations. In considering the extent of the design rights, the broken lines shown in the representations are for illustrative purposes only and do not form part of the design.**



(21) Design Number: **10279/2014**  
(22) Date of Filing Application: **22 January 2014**  
(24) Date from which industrial property rights may have effect: **22 January 2014**  
(54) Product in respect of which the design is registered: **Eyeglass component**  
(51) International Design Classification: **16-06**  
(74) Name(s) of Attorney(s): **Davies Collison Cave**  
(71) Name(s) and Address(s) of Applicant(s):

**Oakley, Inc.**  
**One Icon Foothill Ranch California 92610 United States of America**

(72) Name(s) of Designer(s): **Lek Haagen Thixton and Peter K. Yee**

(45) Registration Date: **01 May 2014**

(30) Convention priority data:

(31) Number	(32) Date	(33) Country
<b>29/470,923</b>	<b>25 Oct 2013</b>	<b>UNITED STATES OF AMERICA</b>

(56) Related Art Documents: **Not Applicable**

(57) Statement of Newness and Distinctiveness: **Newness and distinctiveness is claimed in the visual features shown in solid lines in the representations. In considering the extent of the design rights, the broken lines shown in the representations are for illustrative purposes only and do not form part of the design.**

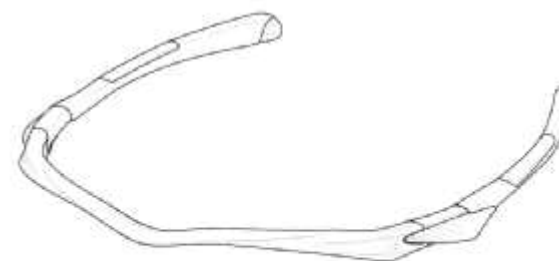

(21) Design Number: **10838/2014**  
(22) Date of Filing Application: **25 February 2014**  
(24) Date from which industrial property rights may have effect: **25 February 2014**  
(54) Product in respect of which the design is registered: **Hooks**  
(51) International Design Classification: **08-08G**  
(74) Name(s) of Attorney(s): **Davies Collison Cave**  
(71) Name(s) and Address(s) of Applicant(s):  
**3M Innovative Properties Company**  
**3M Center Saint Paul Minnesota, 55133-3427 United States of America**  
(72) Name(s) of Designer(s): **Angela L. Pan and Giuseppe De Bellis**  
(45) Registration Date: **01 May 2014**  
(30) Convention priority data:  
(31) Number (32) Date (33) Country  
**29/465463 28 Aug 2013 UNITED STATES OF AMERICA**  
(56) Related Art Documents: **Not Applicable**  
(57) Statement of Newness and Distinctiveness: **Newness and distinctiveness is claimed in the visual features shown in solid lines in the representations. In considering the extent of the design rights, the broken lines shown in the representations are for illustrative purposes only and do not form part of the design.**

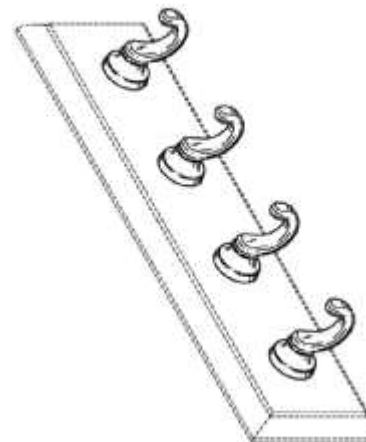

(21) Design Number: **11199/2014**  
(22) Date of Filing Application: **14 March 2014**  
(24) Date from which industrial property rights may have effect: **14 March 2014**  
(54) Product in respect of which the design is registered: **Device for securing a grating**  
(51) International Design Classification: **08-05F**  
(74) Name(s) of Attorney(s): **Davies Collison Cave**  
(71) Name(s) and Address(s) of Applicant(s):  
**DJB Engineering Solutions Pty Ltd**  
**5 Stradbroke Rd Boronia VIC 3155 Australia**  
(72) Name(s) of Designer(s): **David Bowen**  
(45) Registration Date: **01 May 2014**  
(56) Related Art Documents: **Not Applicable**  
(57) Statement of Newness and Distinctiveness: **Newness and distinctiveness is claimed in the features of shape and configuration of a device for securing a grating as shown in the representations.**



(21) Design Number: **11387/2014**  
(22) Date of Filing Application: **25 March 2014**  
(24) Date from which industrial property rights may have effect: **25 March 2014**  
(54) Product in respect of which the design is registered: **Pipe coupling segment**  
(51) International Design Classification: **23-01A**  
(74) Name(s) of Attorney(s): **SPRUSON & FERGUSON**  
(71) Name(s) and Address(s) of Applicant(s):  
**Victaulic Company**  
**4901 Kesslersville Road Easton Pennsylvania 18040 United States of America**  
(72) Name(s) of Designer(s): **Scott D Madara and Charles E Wilk Jr and Anthony J Cuvo and Douglas R Dole**  
(45) Registration Date: **01 May 2014**  
(30) Convention priority data:  
(31) Number (32) Date (33) Country  
**29/467976 25 Sep 2013 UNITED STATES OF AMERICA**  
(56) Related Art Documents: **Not Applicable**  
(57) Statement of Newness and Distinctiveness: **Newness and distinctiveness is claimed in those features of shape and/or configuration of a pipe coupling segment illustrated in continuous lines in the accompanying representations.**

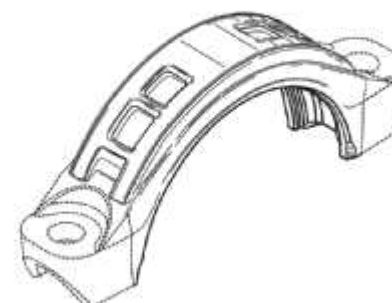

(21) Design Number: **11604/2014**  
(22) Date of Filing Application: **01 April 2014**  
(24) Date from which industrial property rights may have effect: **01 April 2014**  
(54) Product in respect of which the design is registered: **Tyre for motorcycle**  
(51) International Design Classification: **12-15B**  
(74) Name(s) of Attorney(s): **SPRUSON & FERGUSON**  
(71) Name(s) and Address(s) of Applicant(s):  
**The Goodyear Tire & Rubber Company**  
**1144 East Market Street Akron Ohio 44316-0001 United States of America**  
(72) Name(s) of Designer(s): **Wataru Isaka**  
(45) Registration Date: **01 May 2014**  
(30) Convention priority data:  
(31) Number (32) Date (33) Country  
**2013-023824 11 Oct 2013 JAPAN**  
(56) Related Art Documents: **Not Applicable**  
(57) Statement of Newness and Distinctiveness: **Newness and distinctiveness is claimed in the features of shape and/or configuration of the tread of a tyre for a motorcycle as illustrated in the accompanying representations, wherein the shape and/or configuration of the tread is repeated throughout the circumference of the tyre.**



(21) Design Number: **11605/2014**  
(22) Date of Filing Application: **01 April 2014**  
(24) Date from which industrial property rights may have effect: **01 April 2014**  
(54) Product in respect of which the design is registered: **Tyre for motorcycle**  
(51) International Design Classification: **12-15B**  
(74) Name(s) of Attorney(s): **SPRUSON & FERGUSON**  
(71) Name(s) and Address(s) of Applicant(s):

**The Goodyear Tire & Rubber Company**  
**1144 East Market Street Akron Ohio 44316-0001 United States of America**

(72) Name(s) of Designer(s): **Wataru Isaka**

(45) Registration Date: **01 May 2014**

(30) Convention priority data:

(31) Number	(32) Date	(33) Country
<b>2013-023825</b>	<b>11 Oct 2013</b>	<b>JAPAN</b>

(56) Related Art Documents: **Not Applicable**

(57) Statement of Newness and Distinctiveness: **Newness and distinctiveness is claimed in the features of shape and/or configuration of the tread of a tyre for a motorcycle as illustrated in the accompanying representations, wherein the shape and/or configuration of the tread is repeated throughout the circumference of the tyre.**



(21) Design Number: **11678/2014**  
(22) Date of Filing Application: **04 April 2014**  
(24) Date from which industrial property rights may have effect: **04 April 2014**  
(54) Product in respect of which the design is registered: **Respiratory apparatus**  
(51) International Design Classification: **24-04**  
(74) Name(s) of Attorney(s): **Griffith Hack**  
(71) Name(s) and Address(s) of Applicant(s):

**Teva UK Limited**  
**Ridings Point Whistler Drive Castleford West Yorkshire WF10 5HX**  
**United Kingdom**

**Teva Pharmaceuticals Europe B.V.**  
**Computerweg 10 3542 DR Utrecht Netherlands**

(72) Name(s) of Designer(s): **Mark Milton-Edwards and Michiel Ullmann**

(45) Registration Date: **01 May 2014**

(30) Convention priority data:

(31) Number	(32) Date	(33) Country
<b>002322016</b>	<b>08 Oct 2013</b>	<b>OFFICE FOR HARMONISATION IN THE INTERNAL MARKET (OHIM)</b>

(56) Related Art Documents: **Not Applicable**

(57) Statement of Newness and Distinctiveness: **Newness and distinctiveness resides in the visual features, including the translucency, colour and/or contrasting, of the cap of a RESPIRATORY APPARATUS, as shown in the accompanying drawings.**

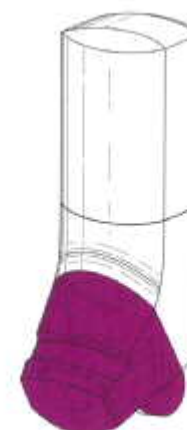

(21) Design Number: **11682/2014**  
(22) Date of Filing Application: **04 April 2014**  
(24) Date from which industrial property rights may have effect: **04 April 2014**  
(54) Product in respect of which the design is registered: **Respiratory apparatus**  
(51) International Design Classification: **24-04**  
(74) Name(s) of Attorney(s): **Griffith Hack**  
(71) Name(s) and Address(s) of Applicant(s):

**Teva UK Limited**  
**Ridings Point Whistler Drive Castleford West Yorkshire WF10 5HX**  
**United Kingdom**

**Teva Pharmaceuticals Europe B.V.**  
**Computerweg 10 3542 DR Utrecht The Netherlands**

(72) Name(s) of Designer(s): **Mark Milton-Edwards and Michiel Ullmann**

(45) Registration Date: **02 May 2014**

(30) Convention priority data:

(31) Number	(32) Date	(33) Country
<b>002322024</b>	<b>08 Oct 2013</b>	<b>OFFICE FOR HARMONISATION IN THE INTERNAL MARKET (OHIM)</b>

(56) Related Art Documents: **Not Applicable**

(57) Statement of Newness and Distinctiveness: **Newness and distinctiveness resides in the visual features, including the translucency, colour and/or contrasting, of the cap of a RESPIRATORY APPARATUS, as shown in the accompanying drawings.**

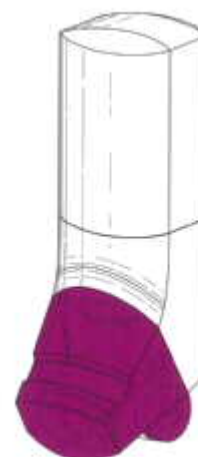

(21) Design Number: **11686/2014**  
(22) Date of Filing Application: **04 April 2014**  
(24) Date from which industrial property rights may have effect: **04 April 2014**  
(54) Product in respect of which the design is registered: **Tyre**  
(51) International Design Classification: **12-15C**  
(74) Name(s) of Attorney(s):  
(71) Name(s) and Address(s) of Applicant(s):

**Jinlin Ma**  
**Rm.701 Block 1 Anhuaxuan Ruihuayuannei St. Middle Jiejn Rd.Panyu**  
**Dist. Guangzhou City Guangdong Province China**

(72) Name(s) of Designer(s): **Jinlin Ma**

(45) Registration Date: **02 May 2014**

(56) Related Art Documents: **Not Applicable**

(57) Statement of Newness and Distinctiveness: **Nil**



- (21) Design Number: **11687/2014**  
(22) Date of Filing Application: **04 April 2014**  
(24) Date from which industrial property rights may have effect: **04 April 2014**  
(54) Product in respect of which the design is registered: **A textile print**  
(51) International Design Classification: **05-05B**  
(74) Name(s) of Attorney(s):  
(71) Name(s) and Address(s) of Applicant(s):  
**AUSTRALIAN FASHION LABELS PTY LTD**  
**106 Currie St Adelaide SA 5000 Australia**  
(72) Name(s) of Designer(s): **Kathryn Forth and Siham Elmawey**  
(45) Registration Date: **02 May 2014**  
(56) Related Art Documents: **Not Applicable**  
(57) Statement of Newness and Distinctiveness: **Newness and distinctiveness resides in the features of pattern and ornamentation of a textile print as shown in the accompanying representations.**

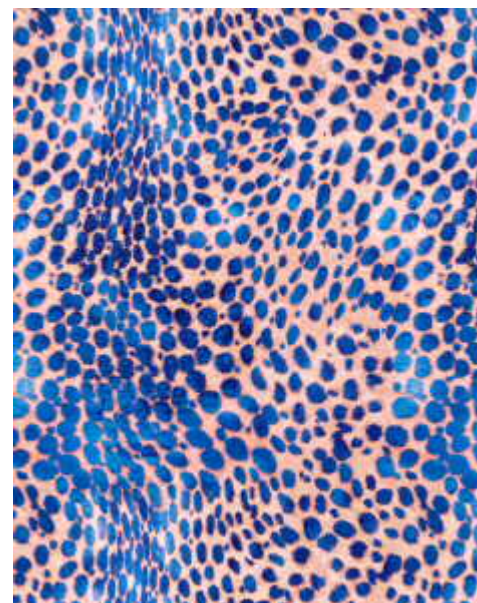

- (21) Design Number: **11688/2014**  
(22) Date of Filing Application: **04 April 2014**  
(24) Date from which industrial property rights may have effect: **04 April 2014**  
(54) Product in respect of which the design is registered: **Safety tag**  
(51) International Design Classification: **19-08**  
(74) Name(s) of Attorney(s): **Rohan Wallace Patent and Trade Mark Services**  
(71) Name(s) and Address(s) of Applicant(s):  
**Accumax Global Pty Ltd**  
**9 Sevenoaks St Bentley WA 6102 Australia**  
(72) Name(s) of Designer(s): **Daniel Martin**  
(45) Registration Date: **02 May 2014**  
(56) Related Art Documents: **Not Applicable**  
(57) Statement of Newness and Distinctiveness: **The features of the shape and / or configuration of the safety tag are new and distinctive. The shape and configuration of holes shown in dashed lines are disclaimed.**

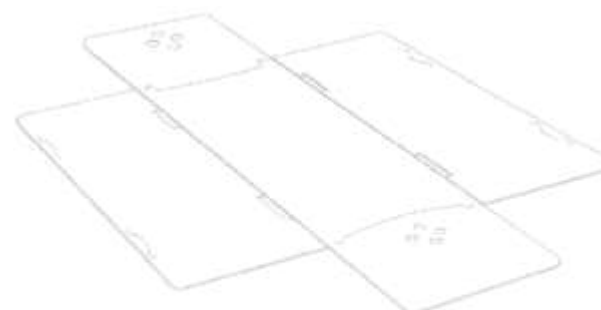

(21) Design Number: **11689/2014**  
(22) Date of Filing Application: **04 April 2014**  
(24) Date from which industrial property rights may have effect: **04 April 2014**  
(54) Product in respect of which the design is registered: **Tyre**  
(51) International Design Classification: **12-15A**  
(74) Name(s) of Attorney(s):  
(71) Name(s) and Address(s) of Applicant(s):  
**Jinlin Ma**  
**Rm. 701, Block 1, Anhuaxuan Ruihuayuannei St., Middle Jiejing Rd.**  
**Panyu Dist., Guangzhou City Guangdong Province China**  
(72) Name(s) of Designer(s): **Jinlin Ma**  
(45) Registration Date: **02 May 2014**  
(56) Related Art Documents: **Not Applicable**  
(57) Statement of Newness and Distinctiveness: **Nil**



(21) Design Number: **11690/2014**  
(22) Date of Filing Application: **04 April 2014**  
(24) Date from which industrial property rights may have effect: **04 April 2014**  
(54) Product in respect of which the design is registered: **Razor cartridge**  
(51) International Design Classification: **28-03A**  
(74) Name(s) of Attorney(s): **PHILLIPS ORMONDE FITZPATRICK**  
(71) Name(s) and Address(s) of Applicant(s):  
**The Gillette Company**  
**One Gillette Park Boston Massachusetts 02127 United States of America**  
(72) Name(s) of Designer(s): **Stephen Charles Witkus and Neil Lettenberger**  
**and Armando Miguel Hurtado**  
(45) Registration Date: **02 May 2014**  
(30) Convention priority data:  
(31) Number (32) Date (33) Country  
**29/472,583 13 Nov 2013 UNITED STATES OF AMERICA**  
(56) Related Art Documents: **Not Applicable**  
(57) Statement of Newness and Distinctiveness: **Those features of the razor cartridge depicted in the representations that are new and distinctive are the shape and/or configuration. The features shown in broken lines are not part of the design and are to be disregarded when considering the overall impression of the design.**

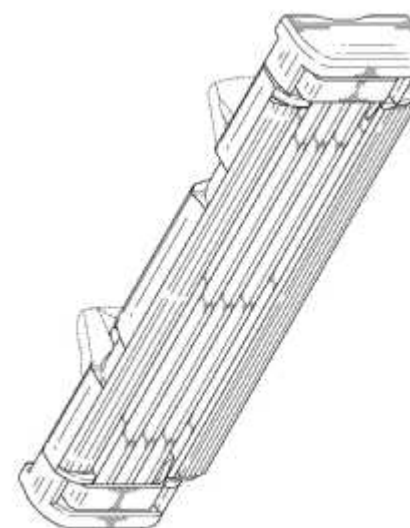

(21) Design Number: **11692/2014**

(22) Date of Filing Application: **04 April 2014**

(24) Date from which industrial property rights may have effect: **04 April 2014**

(54) Product in respect of which the design is registered: **String trimmer**

(51) International Design Classification: **08-03**

(74) Name(s) of Attorney(s): **Wrays**

(71) Name(s) and Address(s) of Applicant(s):

**Chevron (HK) Limited**

**Room 803B 8/F Allied Kajima Building 138 Gloucester Road Wanchai  
Hong Kong**

(72) Name(s) of Designer(s): **Jicheng Jiang**

(45) Registration Date: **02 May 2014**

(56) Related Art Documents: **Not Applicable**

(57) Statement of Newness and Distinctiveness: **Newness and distinctiveness is claimed in the features of shape and/or configuration of the String Trimmer depicted in the accompanying representations.**

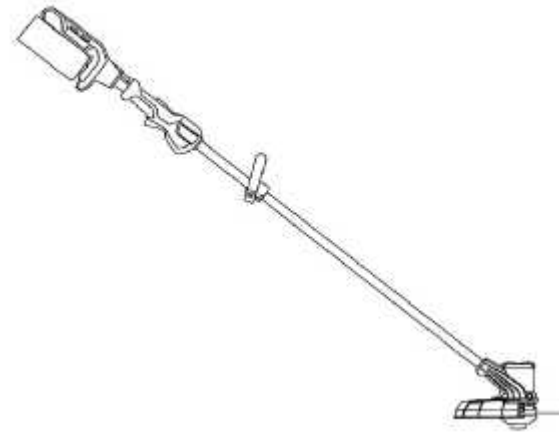

(21) Design Number: **11693/2014**

(22) Date of Filing Application: **04 April 2014**

(24) Date from which industrial property rights may have effect: **04 April 2014**

(54) Product in respect of which the design is registered: **Hedge trimmer**

(51) International Design Classification: **08-03**

(74) Name(s) of Attorney(s): **Wrays**

(71) Name(s) and Address(s) of Applicant(s):

**Chevron (HK) Limited**

**Room 803B 8/F Allied Kajima Building 138 Gloucester Road Wanchai  
Hong Kong China**

(72) Name(s) of Designer(s): **Jicheng Jiang**

(45) Registration Date: **02 May 2014**

(56) Related Art Documents: **Not Applicable**

(57) Statement of Newness and Distinctiveness: **Newness and distinctiveness is claimed in the features of shape and/or configuration of the Hedge Trimmer depicted in the accompanying representations.**



- (21) Design Number: **11694/2014**  
(22) Date of Filing Application: **04 April 2014**  
(24) Date from which industrial property rights may have effect: **04 April 2014**  
(54) Product in respect of which the design is registered: **A Bottle**  
(51) International Design Classification: **09-01NES**  
(74) Name(s) of Attorney(s): **Cullens Patent and Trade Mark Attorneys**  
(71) Name(s) and Address(s) of Applicant(s):  
**ALDI Foods Pty Ltd**  
**1 Sargents Rd Minchinbury NSW 2770 Australia**  
(72) Name(s) of Designer(s): **Redell Macabenta**  
(45) Registration Date: **02 May 2014**  
(56) Related Art Documents: **Not Applicable**  
(57) Statement of Newness and Distinctiveness: **The new and distinctive features are the features of shape and configuration of the bottle as shown in black lines in the accompanying representations. The blue lines (which represent outlines of labels but which are included for illustrative purposes only) are not part of the design and are to be disregarded when considering the overall impression of the design.**

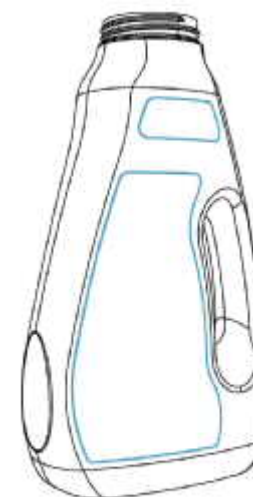

- (21) Design Number: **11695/2014**  
(22) Date of Filing Application: **04 April 2014**  
(24) Date from which industrial property rights may have effect: **04 April 2014**  
(54) Product in respect of which the design is registered: **Vaginal ring applicator**  
(51) International Design Classification: **24-02**  
(74) Name(s) of Attorney(s): **Shelston IP**  
(71) Name(s) and Address(s) of Applicant(s):  
**Merck Sharp & Dohme B.V**  
**Waarderweg 39 Haarlem 2031 BN Netherlands**  
(72) Name(s) of Designer(s): **Cornelis P M Govers and Owen Callaghan and Mario A A De Zeeuw and Joris M Swaak and Marco A Voogsgerd**  
(45) Registration Date: **02 May 2014**  
(30) Convention priority data:  
(31) Number      (32) Date      (33) Country  
**29/472128      08 Nov 2013      UNITED STATES OF AMERICA**  
(56) Related Art Documents: **Not Applicable**  
(57) Statement of Newness and Distinctiveness: **Newness and distinctiveness reside in the features of shape and/or configuration of a VAGINAL RING APPLICATOR as illustrated in solid lines in the accompanying representations. The features shown in broken lines are illustrative only and do not form part of the design.**



(21) Design Number: **11696/2014**  
(22) Date of Filing Application: **04 April 2014**  
(24) Date from which industrial property rights may have effect: **04 April 2014**  
(54) Product in respect of which the design is registered: **Plumbing fitting**  
(51) International Design Classification: **23-01B**  
(74) Name(s) of Attorney(s): **Pizzeys**  
(71) Name(s) and Address(s) of Applicant(s):  
**Zurn Industries, LLC.**  
**5900 Elwin Buchanan Drive Sanford NC, 27330 United States of America**  
(72) Name(s) of Designer(s): **John Kevin Schoolcraft and Craig Saunders and Paul Stephens and Jason Tilk and Alex Velet and Michael Liebal and Sean M Chenard and Roy Leviner**  
(45) Registration Date: **02 May 2014**  
(30) Convention priority data:  
(31) Number (32) Date (33) Country  
**29/471,339 30 Oct 2013 UNITED STATES OF AMERICA**  
(56) Related Art Documents: **Not Applicable**  
(57) Statement of Newness and Distinctiveness: **Nil**



(21) Design Number: **10573/2014**  
(22) Date of Filing Application: **06 February 2014**  
(24) Date from which industrial property rights may have effect: **06 February 2014**  
(54) Product in respect of which the design is registered: **Shirt with hidden microfiber cloth**  
(51) International Design Classification: **02-02NES**  
(74) Name(s) of Attorney(s):  
(71) Name(s) and Address(s) of Applicant(s):  
**Anthony Daniel**  
**12 Paradise Cl Cherrybrook NSW 2126 Australia**  
(72) Name(s) of Designer(s): **Anthony Daniel**  
(45) Registration Date: **02 May 2014**  
(56) Related Art Documents: **Not Applicable**  
(57) Statement of Newness and Distinctiveness: **The newness and distinctiveness of the design resides in having the hidden microfiber cloth in the shirt, yet easily accessible for when needed, under the front tail.**

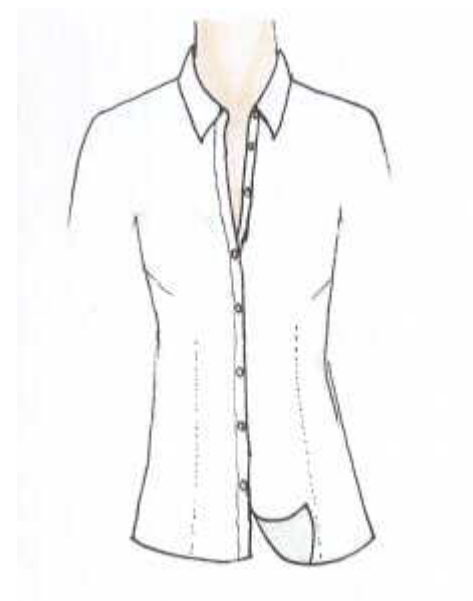

- (21) Design Number: **10990/2014**  
(22) Date of Filing Application: **04 March 2014**  
(24) Date from which industrial property rights may have effect: **04 March 2014**  
(54) Product in respect of which the design is registered: **Lamp cloud**  
(51) International Design Classification: **26-05E**  
(74) Name(s) of Attorney(s):  
(71) Name(s) and Address(s) of Applicant(s):

**Andrzej Loza**  
**31 Alex Ave Moorabbin VIC 3189 Australia**

- (72) Name(s) of Designer(s): **Andrzej Loza**

(45) Registration Date: **02 May 2014**

(56) Related Art Documents: **Not Applicable**

- (57) Statement of Newness and Distinctiveness: **Each part of lamp CLOUD is made of any bendable/flexible material, such as timber, plexiglass, and alike but not limited to. Each part is furnished with led light strips inserted in recess of any side of the profiled part. Design allows for: change in each dimensions, for adding or removing profiled part either lengthwise or widthwise or both. Design applies to lighting products in the same class of products: Ceiling lamp drawing no: 1359/01 Pendant lamp drawing no: 1359/02 Infinity lamp drawing no: 1359/03 Floor lamp drawing no: 1359/04 Wall lamp drawing no: 1359/05 Newness and distinctiveness is in: Design Shape Possibility to change configuration and dimensions Changes in configuration of profiled parts may result in changes in the application of the lamp (ceiling lamp, pendant lamp, infinity lamp, floor lamp, wall lamp). Monopoly is claimed in the features of shape of the product as illustrated in the drawings enclosed.**



- (21) Design Number: **11059/2014**  
(22) Date of Filing Application: **07 March 2014**  
(24) Date from which industrial property rights may have effect: **07 March 2014**  
(54) Product in respect of which the design is registered: **Bonnet scoop for motor vehicle**  
(51) International Design Classification: **12-16B**  
(74) Name(s) of Attorney(s):  
(71) Name(s) and Address(s) of Applicant(s):

**HDT SPECIAL VEHICLES PTY LTD**  
**PO BOX 323 Yeppoon QLD 4703 Australia**

- (72) Name(s) of Designer(s): **Peter Champion**

(45) Registration Date: **02 May 2014**

(56) Related Art Documents: **Not Applicable**

- (57) Statement of Newness and Distinctiveness: **Unique and distinctive design to suit VF Commodore Bonnet.**



(21) Design Number: **11411/2014**  
(22) Date of Filing Application: **26 March 2014**  
(24) Date from which industrial property rights may have effect: **26 March 2014**  
(54) Product in respect of which the design is registered: **Outdoor flyscreen blind**  
(51) International Design Classification: **25-02H**  
(74) Name(s) of Attorney(s):  
(71) Name(s) and Address(s) of Applicant(s):  
**Desmond Wade Bankier**  
**50 Green Mist Cres Botanic Ridge VIC 3977 Australia**  
(72) Name(s) of Designer(s): **Desmond Wade Bankier**  
(45) Registration Date: **02 May 2014**  
(56) Related Art Documents: **Not Applicable**  
(57) Statement of Newness and Distinctiveness: **Constructed from PVC coated Fibreglass flyscreen Protects outdoor living and entertaining areas from insects 97% openness to retain views and allow breeze to pass through Slimline aluminium sail track head rail Dual Pulley for left or right side operation Full length zips to eliminate gaps when installed Detachable cords for aesthetics and child safety.**

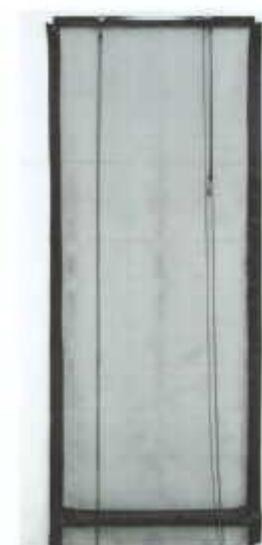

(21) Design Number: **10906/2014**  
(22) Date of Filing Application: **28 February 2014**  
(24) Date from which industrial property rights may have effect: **28 February 2014**  
(54) Product in respect of which the design is registered: **Eyeglass component**  
(51) International Design Classification: **16-06**  
(74) Name(s) of Attorney(s): **Davies Collison Cave**  
(71) Name(s) and Address(s) of Applicant(s):  
**Oakley, Inc.**  
**One Icon Foothill Ranch California 92610 United States of America**  
(72) Name(s) of Designer(s): **Hans Karsten Moritz**  
(45) Registration Date: **02 May 2014**  
(30) Convention priority data:  
(31) Number (32) Date (33) Country  
**29/477,335 20 Dec 2013 UNITED STATES OF AMERICA**  
(56) Related Art Documents: **Not Applicable**  
(57) Statement of Newness and Distinctiveness: **Newness and distinctiveness is claimed in the visual features shown in solid lines in the representations. In considering the extent of the design rights, the broken lines shown in the representations are for illustrative purposes only and do not form part of the design.**



(21) Design Number: **10908/2014**  
(22) Date of Filing Application: **28 February 2014**  
(24) Date from which industrial property rights may have effect: **28 February 2014**  
(54) Product in respect of which the design is registered: **Eyeglass component**  
(51) International Design Classification: **16-06**  
(74) Name(s) of Attorney(s): **Davies Collison Cave**  
(71) Name(s) and Address(s) of Applicant(s):

**Oakley, Inc.**  
**One Icon Foothill Ranch California 92610 United States of America**

(72) Name(s) of Designer(s): **George Yoo**

(45) Registration Date: **02 May 2014**

(30) Convention priority data:

(31) Number	(32) Date	(33) Country
<b>29/477,376</b>	<b>20 Dec 2013</b>	<b>UNITED STATES OF AMERICA</b>

(56) Related Art Documents: **Not Applicable**

(57) Statement of Newness and Distinctiveness: **Newness and distinctiveness is claimed in the features of shape and configuration of the eyeglass component as shown in solid lines in the representations. In considering the extent of the design rights, the broken lines shown in the representations are for illustrative purposes only and do not form part of the design.**



(21) Design Number: **10913/2014**  
(22) Date of Filing Application: **28 February 2014**  
(24) Date from which industrial property rights may have effect: **28 February 2014**  
(54) Product in respect of which the design is registered: **Eyeglass component**  
(51) International Design Classification: **16-06**  
(74) Name(s) of Attorney(s): **Davies Collison Cave**  
(71) Name(s) and Address(s) of Applicant(s):

**Oakley, Inc.**  
**One Icon Foothill Ranch California 92610 United States of America**

(72) Name(s) of Designer(s): **Lek Haagen Thixton**

(45) Registration Date: **02 May 2014**

(30) Convention priority data:

(31) Number	(32) Date	(33) Country
<b>29/477,377</b>	<b>20 Dec 2013</b>	<b>UNITED STATES OF AMERICA</b>

(56) Related Art Documents: **Not Applicable**

(57) Statement of Newness and Distinctiveness: **Newness and distinctiveness is claimed in the visual features shown in solid lines in the representations. In considering the extent of the design rights, the broken lines shown in the representations are for illustrative purposes only and do not form part of the design.**



(21) Design Number: **10926/2014**  
(22) Date of Filing Application: **28 February 2014**  
(24) Date from which industrial property rights may have effect: **28 February 2014**  
(54) Product in respect of which the design is registered: **Eyeglass component**  
(51) International Design Classification: **16-06**  
(74) Name(s) of Attorney(s): **Davies Collison Cave**  
(71) Name(s) and Address(s) of Applicant(s):

**Oakley, Inc.**  
**One Icon Foothill Ranch California 92610 United States of America**

(72) Name(s) of Designer(s): **Jae Shin**

(45) Registration Date: **02 May 2014**

(30) Convention priority data:

(31) Number	(32) Date	(33) Country
<b>29/477,303</b>	<b>20 Dec 2013</b>	<b>UNITED STATES OF AMERICA</b>

(56) Related Art Documents: **Not Applicable**

(57) Statement of Newness and Distinctiveness: **Newness and distinctiveness is claimed in the visual features shown in solid lines in the representations. In considering the extent of the design rights, the broken lines shown in the representations are for illustrative purposes only and do not form part of the design.**



(21) Design Number: **11708/2014**  
(22) Date of Filing Application: **07 April 2014**  
(24) Date from which industrial property rights may have effect: **25 July 2013**  
(54) Product in respect of which the design is registered: **Article of clothing**  
(51) International Design Classification: **02-02NES**  
(74) Name(s) of Attorney(s): **Allens Patent & Trade Mark Attorneys**  
(71) Name(s) and Address(s) of Applicant(s):

**Forever New Clothing Pty Ltd**  
**714-716 High St Kew East VIC 3102 Australia**

(72) Name(s) of Designer(s): **Chloe Atkinson**

(45) Registration Date: **02 May 2014**

(62) Divisional of: **354887**

(56) Related Art Documents: **Not Applicable**

(57) Statement of Newness and Distinctiveness: **Newness and distinctiveness resides in the visual features of shape, configuration, pattern and/or ornamentation of an article of clothing as shown in the accompanying representations.**



- (21) Design Number: **11709/2014**  
(22) Date of Filing Application: **07 April 2014**  
(24) Date from which industrial property rights may have effect: **25 July 2013**  
(54) Product in respect of which the design is registered: **Article of clothing**  
(51) International Design Classification: **02-02NES**  
(74) Name(s) of Attorney(s): **Allens Patent & Trade Mark Attorneys**  
(71) Name(s) and Address(s) of Applicant(s):  
**Forever New Clothing Pty Ltd**  
**714-716 High St Kew East VIC 3102 Australia**  
(72) Name(s) of Designer(s): **Chloe Atkinson**  
(45) Registration Date: **02 May 2014**  
(62) Divisional of: **354887**  
(56) Related Art Documents: **Not Applicable**  
(57) Statement of Newness and Distinctiveness: **Newness and distinctiveness resides in the visual features of shape, configuration, pattern and/or ornamentation of an article of clothing as shown in the accompanying representations.**

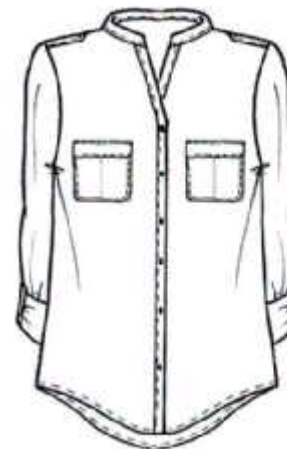

- (21) Design Number: **11710/2014**  
(22) Date of Filing Application: **07 April 2014**  
(24) Date from which industrial property rights may have effect: **25 July 2013**  
(54) Product in respect of which the design is registered: **Article of clothing**  
(51) International Design Classification: **02-02C**  
(74) Name(s) of Attorney(s): **Allens Patent & Trade Mark Attorneys**  
(71) Name(s) and Address(s) of Applicant(s):  
**Forever New Clothing Pty Ltd**  
**714-716 High St Kew East VIC 3102 Australia**  
(72) Name(s) of Designer(s): **Karen Thai**  
(45) Registration Date: **02 May 2014**  
(62) Divisional of: **354887**  
(56) Related Art Documents: **Not Applicable**  
(57) Statement of Newness and Distinctiveness: **Newness and distinctiveness resides in the visual features of shape, configuration, pattern and/or ornamentation of an article of clothing as shown in the accompanying representations.**

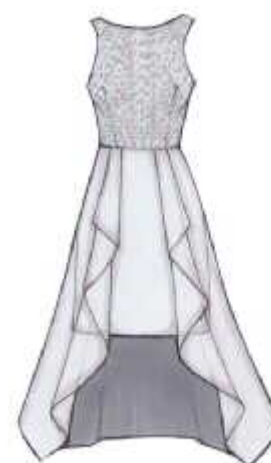

- (21) Design Number: **11711/2014**  
(22) Date of Filing Application: **07 April 2014**  
(24) Date from which industrial property rights may have effect: **25 July 2013**  
(54) Product in respect of which the design is registered: **Article of clothing**  
(51) International Design Classification: **02-02C**  
(74) Name(s) of Attorney(s): **Allens Patent & Trade Mark Attorneys**  
(71) Name(s) and Address(s) of Applicant(s):  
**Forever New Clothing Pty Ltd**  
**714-716 High St Kew East VIC 3102 Australia**  
(72) Name(s) of Designer(s): **Karen Thai**  
(45) Registration Date: **02 May 2014**  
(62) Divisional of: **354887**  
(56) Related Art Documents: **Not Applicable**  
(57) Statement of Newness and Distinctiveness: **Newness and distinctiveness resides in the visual features of shape, configuration, pattern and/or ornamentation of an article of clothing as shown in the accompanying representations.**



- (21) Design Number: **11713/2014**  
(22) Date of Filing Application: **07 April 2014**  
(24) Date from which industrial property rights may have effect: **25 July 2013**  
(54) Product in respect of which the design is registered: **Article of clothing**  
(51) International Design Classification: **02-02C**  
(74) Name(s) of Attorney(s): **Allens Patent & Trade Mark Attorneys**  
(71) Name(s) and Address(s) of Applicant(s):  
**Forever New Clothing Pty Ltd**  
**714-716 High St Kew East VIC 3102 Australia**  
(72) Name(s) of Designer(s): **Karen Thai**  
(45) Registration Date: **02 May 2014**  
(62) Divisional of: **354887**  
(56) Related Art Documents: **Not Applicable**  
(57) Statement of Newness and Distinctiveness: **Newness and distinctiveness resides in the visual features of shape, configuration, pattern and/or ornamentation of an article of clothing as shown in the accompanying representations.**



- (21) Design Number: **11714/2014**  
(22) Date of Filing Application: **07 April 2014**  
(24) Date from which industrial property rights may have effect: **25 July 2013**  
(54) Product in respect of which the design is registered: **Article of clothing**  
(51) International Design Classification: **02-02C**  
(74) Name(s) of Attorney(s): **Allens Patent & Trade Mark Attorneys**  
(71) Name(s) and Address(s) of Applicant(s):  
**Forever New Clothing Pty Ltd**  
**714-716 High St Kew East VIC 3102 Australia**  
(72) Name(s) of Designer(s): **Karen Thai**  
(45) Registration Date: **02 May 2014**  
(62) Divisional of: **354887**  
(56) Related Art Documents: **Not Applicable**  
(57) Statement of Newness and Distinctiveness: **Newness and distinctiveness resides in the visual features of shape, configuration, pattern and/or ornamentation of an article of clothing as shown in the accompanying representations.**



- (21) Design Number: **11715/2014**  
(22) Date of Filing Application: **07 April 2014**  
(24) Date from which industrial property rights may have effect: **25 July 2013**  
(54) Product in respect of which the design is registered: **Article of clothing**  
(51) International Design Classification: **02-02C**  
(74) Name(s) of Attorney(s): **Allens Patent & Trade Mark Attorneys**  
(71) Name(s) and Address(s) of Applicant(s):  
**Forever New Clothing Pty Ltd**  
**714-716 High St Kew East VIC 3102 Australia**  
(72) Name(s) of Designer(s): **Karen Thai**  
(45) Registration Date: **02 May 2014**  
(62) Divisional of: **354887**  
(56) Related Art Documents: **Not Applicable**  
(57) Statement of Newness and Distinctiveness: **Newness and distinctiveness resides in the visual features of shape, configuration, pattern and/or ornamentation of an article of clothing as shown in the accompanying representations.**



- (21) Design Number: **11716/2014**  
(22) Date of Filing Application: **07 April 2014**  
(24) Date from which industrial property rights may have effect: **25 July 2013**  
(54) Product in respect of which the design is registered: **Article of clothing**  
(51) International Design Classification: **02-02NES**  
(74) Name(s) of Attorney(s): **Allens Patent & Trade Mark Attorneys**  
(71) Name(s) and Address(s) of Applicant(s):  
**Forever New Clothing Pty Ltd**  
**714-716 High St Kew East VIC 3102 Australia**  
(72) Name(s) of Designer(s): **Mantra Ahrendt**  
(45) Registration Date: **02 May 2014**  
(62) Divisional of: **354887**  
(56) Related Art Documents: **Not Applicable**  
(57) Statement of Newness and Distinctiveness: **Newness and distinctiveness resides in the visual features of shape, configuration, pattern and/or ornamentation of an article of clothing as shown in the accompanying representations.**

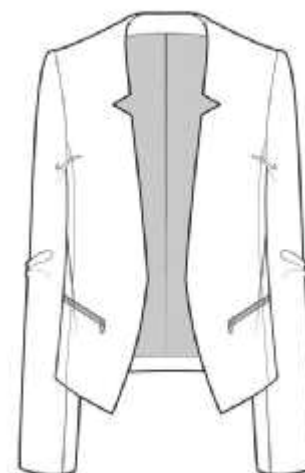

- (21) Design Number: **11717/2014**  
(22) Date of Filing Application: **07 April 2014**  
(24) Date from which industrial property rights may have effect: **25 July 2013**  
(54) Product in respect of which the design is registered: **Article of clothing**  
(51) International Design Classification: **02-02NES**  
(74) Name(s) of Attorney(s): **Allens Patent & Trade Mark Attorneys**  
(71) Name(s) and Address(s) of Applicant(s):  
**Forever New Clothing Pty Ltd**  
**714-716 High St Kew East VIC 3102 Australia**  
(72) Name(s) of Designer(s): **Anna Pham**  
(45) Registration Date: **02 May 2014**  
(62) Divisional of: **354887**  
(56) Related Art Documents: **Not Applicable**  
(57) Statement of Newness and Distinctiveness: **Newness and distinctiveness resides in the visual features of shape, configuration, pattern and/or ornamentation of an article of clothing as shown in the accompanying representations.**

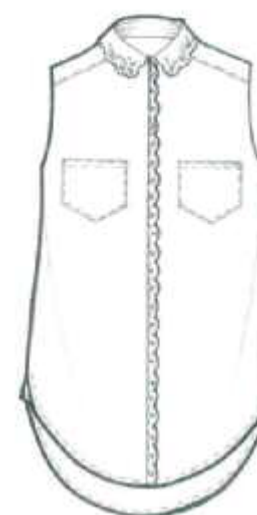

(21) Design Number: **11718/2014**  
(22) Date of Filing Application: **07 April 2014**  
(24) Date from which industrial property rights may have effect: **25 July 2013**  
(54) Product in respect of which the design is registered: **Shoe**  
(51) International Design Classification: **02-04B**  
(74) Name(s) of Attorney(s): **Allens Patent & Trade Mark Attorneys**  
(71) Name(s) and Address(s) of Applicant(s):  
**Forever New Clothing Pty Ltd**  
**714-716 High St Kew East VIC 3102 Australia**  
(72) Name(s) of Designer(s): **Bianca Betts**  
(45) Registration Date: **02 May 2014**  
(62) Divisional of: **354887**  
(56) Related Art Documents: **Not Applicable**  
(57) Statement of Newness and Distinctiveness: **Newness and distinctiveness resides in the visual features of shape, configuration, pattern and/or ornamentation of a shoe as shown in the accompanying representations.**



(21) Design Number: **10134/2014**  
(22) Date of Filing Application: **14 January 2014**  
(24) Date from which industrial property rights may have effect: **14 January 2014**  
(54) Product in respect of which the design is registered: **Injector**  
(51) International Design Classification: **24-02**  
(74) Name(s) of Attorney(s): **Davies Collison Cave**  
(71) Name(s) and Address(s) of Applicant(s):  
**Henke-Sass Wolf GmbH**  
**Keltenstrasse 1 Tuttlingen 78532 Germany**  
(72) Name(s) of Designer(s): **Melanie Eisele and Stefan Knefel**  
(45) Registration Date: **02 May 2014**  
(30) Convention priority data:  
(31) Number      (32) Date      (33) Country  
**002276147-0002    17 Jul 2013      OFFICE FOR HARMONISATION IN  
THE INTERNAL MARKET (OHIM)**  
(56) Related Art Documents: **Not Applicable**  
(57) Statement of Newness and Distinctiveness: **Nil**

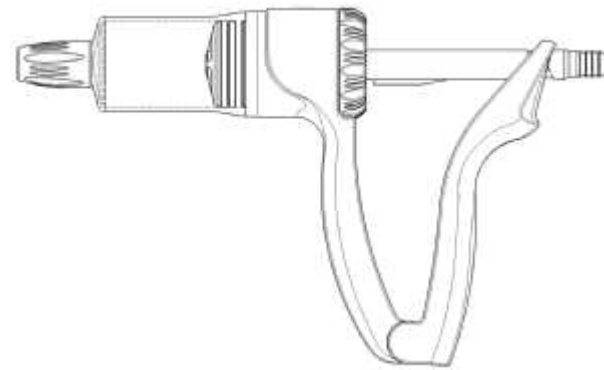

(21) Design Number: **10320/2014**  
(22) Date of Filing Application: **24 January 2014**  
(24) Date from which industrial property rights may have effect: **24 January 2014**  
(54) Product in respect of which the design is registered: **A water heater**  
(51) International Design Classification: **23-03H**  
(74) Name(s) of Attorney(s): **SPRUSON & FERGUSON**  
(71) Name(s) and Address(s) of Applicant(s):  
**Dux Manufacturing Limited**  
**L1 7-9 Irvine PI Norwest Business Park Bella Vista NSW 2153 Australia**  
(72) Name(s) of Designer(s): **Chris Burgess**  
(45) Registration Date: **02 May 2014**  
(56) Related Art Documents: **Not Applicable**  
(57) Statement of Newness and Distinctiveness: **Newness and distinctiveness is claimed in the features of shape and/or configuration of: the three surface indentations in the base and lid; and the element cover of a water heater as illustrated in the accompanying representations.**

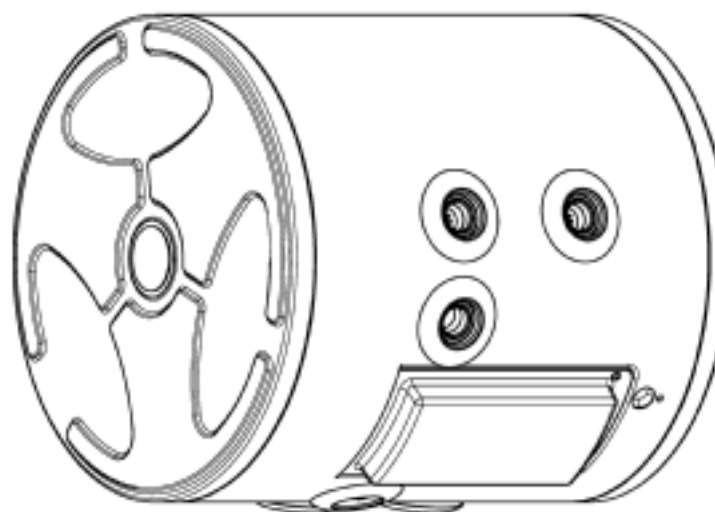

(21) Design Number: **10462/2014**  
(22) Date of Filing Application: **31 January 2014**  
(24) Date from which industrial property rights may have effect: **31 January 2014**  
(54) Product in respect of which the design is registered: **Socket**  
(51) International Design Classification: **08-05NES**  
(74) Name(s) of Attorney(s): **Davies Collison Cave**  
(71) Name(s) and Address(s) of Applicant(s):  
**Orbital Systems AB**  
**Bispgatan 78 Limhamn 216 22 Sweden**  
(72) Name(s) of Designer(s): **Mahdjoubi Namin Amir Mehrdad**  
(45) Registration Date: **02 May 2014**  
(30) Convention priority data:  
(31) Number      (32) Date      (33) Country  
**002285288-0002    01 Aug 2013      OFFICE FOR HARMONISATION IN  
THE INTERNAL MARKET (OHIM)**  
(56) Related Art Documents: **Not Applicable**  
(57) Statement of Newness and Distinctiveness: **Nil**



- (21) Design Number: **10923/2014**  
(22) Date of Filing Application: **28 February 2014**  
(24) Date from which industrial property rights may have effect: **28 February 2014**  
(54) Product in respect of which the design is registered: **Display screen with user interface**  
(51) International Design Classification: **14-01, 14-02**  
(74) Name(s) of Attorney(s): **Shelston IP**  
(71) Name(s) and Address(s) of Applicant(s):  
**Sony Computer Entertainment Inc.**  
**1-7-1 Konan Minato-ku Tokyo 108-0075 Japan**  
(72) Name(s) of Designer(s): **Shuji Hiramatsu and Taku Sugawara and Ikuo Kobayashi**  
(45) Registration Date: **02 May 2014**  
(30) Convention priority data:  
(31) Number      (32) Date      (33) Country  
**2013-025785      01 Nov 2013      JAPAN**  
(56) Related Art Documents: **Not Applicable**  
(57) Statement of Newness and Distinctiveness: **Newness and distinctiveness reside in the features of pattern and/or ornamentation of the Display Screen with User Interface as shown in solid lines in the accompanying representations. The features shown in broken lines form no part of the design. The environment view in the accompanying representations is for illustrative and contextual purposes only and forms no part of the design.**

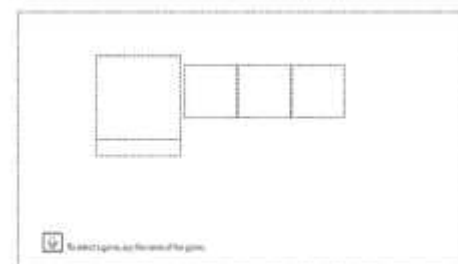

- (21) Design Number: **11698/2014**  
(22) Date of Filing Application: **05 April 2014**  
(24) Date from which industrial property rights may have effect: **05 April 2014**  
(54) Product in respect of which the design is registered: **Shaker bottle**  
(51) International Design Classification: **09-01F**  
(74) Name(s) of Attorney(s):  
(71) Name(s) and Address(s) of Applicant(s):  
**Sports Creative AU Pty. Ltd**  
**587 Nepean Hwy Brighton East VIC 3187 Australia**  
(72) Name(s) of Designer(s): **Richard Beardsell**  
(45) Registration Date: **02 May 2014**  
(56) Related Art Documents: **Not Applicable**  
(57) Statement of Newness and Distinctiveness: **The Sports Creative Shaker has been specifically designed to provide optimum mixing and supplement delivery in a multi-purpose vessel. Its unique pill shape reduces supplement accumulation and creates a dynamic environment for superior mixology. It is topped with an ergonomic consumption spout and can have a additional storage compartment at the bottom.**

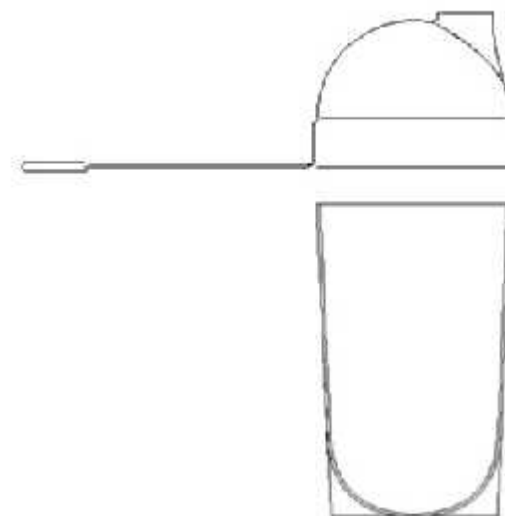

(21) Design Number: **11699/2014**  
(22) Date of Filing Application: **05 April 2014**  
(24) Date from which industrial property rights may have effect: **05 April 2014**  
(54) Product in respect of which the design is registered: **Dental appliance**  
(51) International Design Classification: **24-01**  
(74) Name(s) of Attorney(s):  
(71) Name(s) and Address(s) of Applicant(s):  
**DAVID PENN CONSULTING PTY LTD**  
**16 Transvaal Ave Double Bay NSW 2028 Australia**  
(72) Name(s) of Designer(s): **David Penn**  
(45) Registration Date: **02 May 2014**  
(56) Related Art Documents: **Not Applicable**  
(57) Statement of Newness and Distinctiveness: **Novelty resides in the shape and configuration of the dental appliance as depicted in the accompanying illustrations.**

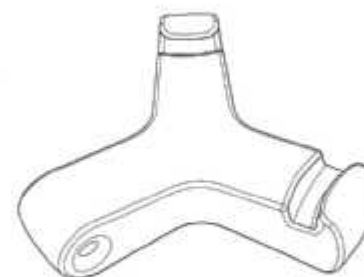

(21) Design Number: **11703/2014**  
(22) Date of Filing Application: **07 April 2014**  
(24) Date from which industrial property rights may have effect: **07 April 2014**  
(54) Product in respect of which the design is registered: **Tyre**  
(51) International Design Classification: **12-15B**  
(74) Name(s) of Attorney(s): **Shelston IP**  
(71) Name(s) and Address(s) of Applicant(s):  
**Shandong Yongtai Chemical Co. Ltd**  
**Rubber Industry Park Dawagntown Guangrao County Dongyingcity**  
**257335 China**  
(72) Name(s) of Designer(s): **Xiaoming You**  
(45) Registration Date: **02 May 2014**  
(30) Convention priority data:  
(31) Number      (32) Date      (33) Country  
**201330496361.6**    **21 Oct 2013**      **CHINA**  
(56) Related Art Documents: **Not Applicable**  
(57) Statement of Newness and Distinctiveness: **Newness and distinctiveness reside in the features of shape and/or configuration of the tread of a TYRE as illustrated in the accompanying representations. The tread being repeated throughout the circumference of the tyre.**



- (21) Design Number: **11704/2014**  
(22) Date of Filing Application: **07 April 2014**  
(24) Date from which industrial property rights may have effect: **07 April 2014**  
(54) Product in respect of which the design is registered: **A pooper scooper**  
(51) International Design Classification: **30-99**  
(74) Name(s) of Attorney(s):  
(71) Name(s) and Address(s) of Applicant(s):  
**Diaspro Enterprises Pty Ltd**  
**36 Monash Pde Dee Why NSW 2099 Australia**  
(72) Name(s) of Designer(s): **Jim Campbell**  
(45) Registration Date: **02 May 2014**  
(56) Related Art Documents: **Not Applicable**  
(57) Statement of Newness and Distinctiveness: **There are two key new and distinctive features to this design: 1. The product has a uniquely curved, shell-like shape that creates a significant internal volumetric capacity. This shape is apparent when the object is open. 2. The broad shell tapers to a sharp, knife-like jaw edge.**



- (21) Design Number: **11705/2014**  
(22) Date of Filing Application: **07 April 2014**  
(24) Date from which industrial property rights may have effect: **07 April 2014**  
(54) Product in respect of which the design is registered: **Tyre**  
(51) International Design Classification: **12-15B**  
(74) Name(s) of Attorney(s): **Shelston IP**  
(71) Name(s) and Address(s) of Applicant(s):  
**Shandong Yongtai Chemical Co. Ltd**  
**Rubber Industry Park Dawagtown Guangrao County Dongyingcity**  
**257335 People's Republic of China**  
(72) Name(s) of Designer(s): **Xiaoming You**  
(45) Registration Date: **02 May 2014**  
(30) Convention priority data:  
(31) Number (32) Date (33) Country  
**201330496309.0 21 Oct 2013 CHINA**  
(56) Related Art Documents: **Not Applicable**  
(57) Statement of Newness and Distinctiveness: **Newness and distinctiveness reside in the features of shape and/or configuration of the tread of a TYRE as illustrated in the accompanying representations. The tread being repeated throughout the circumference of the tyre.**



- (21) Design Number: **11706/2014**  
(22) Date of Filing Application: **07 April 2014**  
(24) Date from which industrial property rights may have effect: **25 July 2013**  
(54) Product in respect of which the design is registered: **Article of clothing**  
(51) International Design Classification: **02-02C**  
(74) Name(s) of Attorney(s): **Allens Patent & Trade Mark Attorneys**  
(71) Name(s) and Address(s) of Applicant(s):  
**Forever New Clothing Pty Ltd**  
**714-716 High St Kew East VIC 3102 Australia**  
(72) Name(s) of Designer(s): **Octavia Miller**  
(45) Registration Date: **02 May 2014**  
(62) Divisional of: **354887**  
(56) Related Art Documents: **Not Applicable**  
(57) Statement of Newness and Distinctiveness: **Newness and distinctiveness resides in the visual features of shape, configuration, pattern and/or ornamentation of an article of clothing as shown in the accompanying representations.**



- (21) Design Number: **11707/2014**  
(22) Date of Filing Application: **07 April 2014**  
(24) Date from which industrial property rights may have effect: **25 July 2013**  
(54) Product in respect of which the design is registered: **Article of clothing**  
(51) International Design Classification: **02-02C**  
(74) Name(s) of Attorney(s): **Allens Patent & Trade Mark Attorneys**  
(71) Name(s) and Address(s) of Applicant(s):  
**Forever New Clothing Pty Ltd**  
**714-716 High St Kew East VIC 3102 Australia**  
(72) Name(s) of Designer(s): **Chloe Atkinson**  
(45) Registration Date: **02 May 2014**  
(62) Divisional of: **354887**  
(56) Related Art Documents: **Not Applicable**  
(57) Statement of Newness and Distinctiveness: **Newness and distinctiveness resides in the visual features of shape, configuration, pattern and/or ornamentation of an article of clothing as shown in the accompanying representations.**



(21) Design Number: **11719/2014**  
(22) Date of Filing Application: **07 April 2014**  
(24) Date from which industrial property rights may have effect: **07 April 2014**  
(54) Product in respect of which the design is registered: **Tyre**  
(51) International Design Classification: **12-15B**  
(74) Name(s) of Attorney(s): **Shelston IP**  
(71) Name(s) and Address(s) of Applicant(s):  
**Shandong Yongtai Chemical Co. Ltd**  
**Rubber Industry Park Dawagntown Guangrao County Dongyingcity**  
**257335 China**  
(72) Name(s) of Designer(s): **Xiaoming You**  
(45) Registration Date: **02 May 2014**  
(30) Convention priority data:  
(31) Number (32) Date (33) Country  
**201330496366.9 21 Oct 2013 CHINA**  
(56) Related Art Documents: **Not Applicable**  
(57) Statement of Newness and Distinctiveness: **Newness and distinctiveness reside in the features of shape and/or configuration of the tread of a TYRE as illustrated in the accompanying representations. The tread being repeated throughout the circumference of the tyre.**



(21) Design Number: **11721/2014**  
(22) Date of Filing Application: **07 April 2014**  
(24) Date from which industrial property rights may have effect: **07 April 2014**  
(54) Product in respect of which the design is registered: **Respiratory apparatus**  
(51) International Design Classification: **24-04**  
(74) Name(s) of Attorney(s): **Griffith Hack**  
(71) Name(s) and Address(s) of Applicant(s):  
**Teva Branded Pharmaceutical Products R&D, Inc**  
**425 Privet Rd Horsham PA 19044-1220 United States of America**  
(72) Name(s) of Designer(s): **Hugh Fosbury and Nicole McInerney**  
(45) Registration Date: **02 May 2014**  
(30) Convention priority data:  
(31) Number (32) Date (33) Country  
**002322123 08 Oct 2013 OFFICE FOR HARMONISATION IN THE INTERNAL MARKET (OHIM)**  
(56) Related Art Documents: **Not Applicable**  
(57) Statement of Newness and Distinctiveness: **Newness and distinctiveness resides in the visual features, including the translucency, colour and/or contrasting, of the cap of a RESPIRATORY APPARATUS, as shown in the accompanying drawings.**



(21) Design Number: **11722/2014**  
(22) Date of Filing Application: **07 April 2014**  
(24) Date from which industrial property rights may have effect: **07 April 2014**  
(54) Product in respect of which the design is registered: **Tyre**  
(51) International Design Classification: **12-15B**  
(74) Name(s) of Attorney(s): **Shelston IP**  
(71) Name(s) and Address(s) of Applicant(s):  
**Shandong Yongtai Chemical Co. Ltd**  
**Rubber Industry Park, Dawagntown Guangrao County Dongyingcity**  
**257335 China**  
(72) Name(s) of Designer(s): **Xiaoming You**  
(45) Registration Date: **02 May 2014**  
(30) Convention priority data:  
(31) Number (32) Date (33) Country  
**201330496365.4 21 Oct 2013 CHINA**  
(56) Related Art Documents: **Not Applicable**  
(57) Statement of Newness and Distinctiveness: **Newness and distinctiveness reside in the features of shape and/or configuration of the tread of a TYRE as illustrated in the accompanying representations. The tread being repeated throughout the circumference of the tyre.**



(21) Design Number: **11724/2014**  
(22) Date of Filing Application: **07 April 2014**  
(24) Date from which industrial property rights may have effect: **07 April 2014**  
(54) Product in respect of which the design is registered: **Respiratory apparatus**  
(51) International Design Classification: **24-04**  
(74) Name(s) of Attorney(s): **Griffith Hack**  
(71) Name(s) and Address(s) of Applicant(s):  
**Teva Branded Pharmaceutical Products R&D, Inc**  
**425 Privet Rd Horsham PA 19044-1220 United States of America**  
(72) Name(s) of Designer(s): **Hugh Fosbury and Nicole McInerney**  
(45) Registration Date: **02 May 2014**  
(30) Convention priority data:  
(31) Number (32) Date (33) Country  
**002322149 08 Oct 2013 OFFICE FOR HARMONISATION IN**  
**THE INTERNAL MARKET (OHIM)**  
(56) Related Art Documents: **Not Applicable**  
(57) Statement of Newness and Distinctiveness: **Newness and distinctiveness resides in the visual features, including the translucency, colour and/or contrasting, of the cap of a RESPIRATORY APPARATUS, as shown in the accompanying drawings.**



(21) Design Number: **11729/2014**

(22) Date of Filing Application: **07 April 2014**

(24) Date from which industrial property rights may have effect: **07 April 2014**

(54) Product in respect of which the design is registered: **Respiratory apparatus**

(51) International Design Classification: **24-04**

(74) Name(s) of Attorney(s): **Griffith Hack**

(71) Name(s) and Address(s) of Applicant(s):

**Teva Branded Pharmaceutical Products R&D, Inc  
425 Privet Rd Horsham PA 19044-1220 United States of America**

(72) Name(s) of Designer(s): **Hugh Fosbury and Nicole McInerney**

(45) Registration Date: **02 May 2014**

(30) Convention priority data:

(31) Number	(32) Date	(33) Country
<b>002322198</b>	<b>08 Oct 2013</b>	<b>OFFICE FOR HARMONISATION IN THE INTERNAL MARKET (OHIM)</b>

(56) Related Art Documents: **Not Applicable**

(57) Statement of Newness and Distinctiveness: **Newness and distinctiveness resides in the visual features, including the translucency, colour and/or contrasting, of the cap of a RESPIRATORY APPARATUS, as shown in the accompanying drawings.**

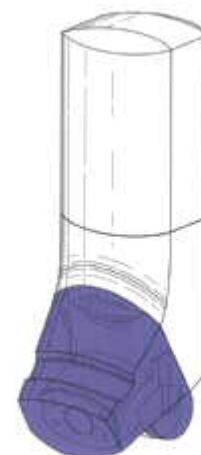

(21) Design Number: **11731/2014**

(22) Date of Filing Application: **07 April 2014**

(24) Date from which industrial property rights may have effect: **07 April 2014**

(54) Product in respect of which the design is registered: **Respiratory apparatus**

(51) International Design Classification: **24-04**

(74) Name(s) of Attorney(s): **Griffith Hack**

(71) Name(s) and Address(s) of Applicant(s):

**Teva Branded Pharmaceutical Products R&D, Inc  
425 Privet Rd Horsham PA 19044-1220 United States of America**

(72) Name(s) of Designer(s): **Hugh Fosbury and Nicole McInerney**

(45) Registration Date: **02 May 2014**

(30) Convention priority data:

(31) Number	(32) Date	(33) Country
<b>002322164</b>	<b>08 Oct 2013</b>	<b>OFFICE FOR HARMONISATION IN THE INTERNAL MARKET (OHIM)</b>

(56) Related Art Documents: **Not Applicable**

(57) Statement of Newness and Distinctiveness: **Newness and distinctiveness resides in the visual features, including the translucency, colour and/or contrasting, of the cap of a RESPIRATORY APPARATUS, as shown in the accompanying drawings.**

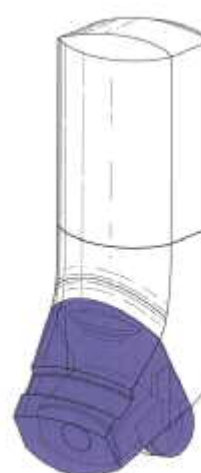

(21) Design Number: **11733/2014**  
(22) Date of Filing Application: **07 April 2014**  
(24) Date from which industrial property rights may have effect: **07 April 2014**  
(54) Product in respect of which the design is registered: **Computing device holder and dock**  
(51) International Design Classification: **14-02**  
(74) Name(s) of Attorney(s): **Griffith Hack**  
(71) Name(s) and Address(s) of Applicant(s):  
**Toshiba Global Commerce Solutions Holdings Corporation**  
**2-17-2, Higashi Gotanda, Shinagawa-ku Tokyo 141-8664 Japan**  
(72) Name(s) of Designer(s): **Brad M Johnson and Robert A Myers and William L Talley and Seth T Teeple**  
(45) Registration Date: **02 May 2014**  
(30) Convention priority data:  
(31) Number (32) Date (33) Country  
**29/469,472 10 Oct 2013 UNITED STATES OF AMERICA**



(56) Related Art Documents: **Not Applicable**  
(57) Statement of Newness and Distinctiveness: **Newness and distinctiveness resides in the visual features, including the shape and configuration of the product shown in the representations. Those parts shown by dashed lines do not form part of the design and have been included for illustrative purposes only.**

(21) Design Number: **11734/2014**  
(22) Date of Filing Application: **07 April 2014**  
(24) Date from which industrial property rights may have effect: **07 April 2014**  
(54) Product in respect of which the design is registered: **Computing device holder**  
(51) International Design Classification: **14-02**  
(74) Name(s) of Attorney(s): **Griffith Hack**  
(71) Name(s) and Address(s) of Applicant(s):  
**Toshiba Global Commerce Solutions Holdings Corporation**  
**2-17-2, Higashi Gotanda, Shinagawa-ku Tokyo 141-8664 Japan**  
(72) Name(s) of Designer(s): **Brad M Johnson and Robert A Myers and William L Talley and Seth T Teeple**  
(45) Registration Date: **02 May 2014**  
(30) Convention priority data:  
(31) Number (32) Date (33) Country  
**29/469,466 10 Oct 2013 UNITED STATES OF AMERICA**



(56) Related Art Documents: **Not Applicable**  
(57) Statement of Newness and Distinctiveness: **Newness and distinctiveness resides in the visual features, including the shape and configuration of the product shown in the representations. Those parts shown by dashed lines do not form part of the design and have been included for illustrative purposes only.**

- (21) Design Number: **11735/2014**  
(22) Date of Filing Application: **07 April 2014**  
(24) Date from which industrial property rights may have effect: **07 April 2014**  
(54) Product in respect of which the design is registered: **Computing device dock**  
(51) International Design Classification: **14-02**  
(74) Name(s) of Attorney(s): **Griffith Hack**  
(71) Name(s) and Address(s) of Applicant(s):  
**Toshiba Global Commerce Solutions Holdings Corporation**  
**2-17-2, Higashi Gotanda, Shinagawa-ku Tokyo 141-8664 Japan**  
(72) Name(s) of Designer(s): **Brad M Johnson and Robert A Myers and William L Talley and Seth T Teeples**  
(45) Registration Date: **02 May 2014**  
(30) Convention priority data:  
(31) Number (32) Date (33) Country  
**29/469,469 10 Oct 2013 UNITED STATES OF AMERICA**  
(56) Related Art Documents: **Not Applicable**  
(57) Statement of Newness and Distinctiveness: **Newness and distinctiveness resides in the visual features, including the shape and configuration of the product shown in the representations.**

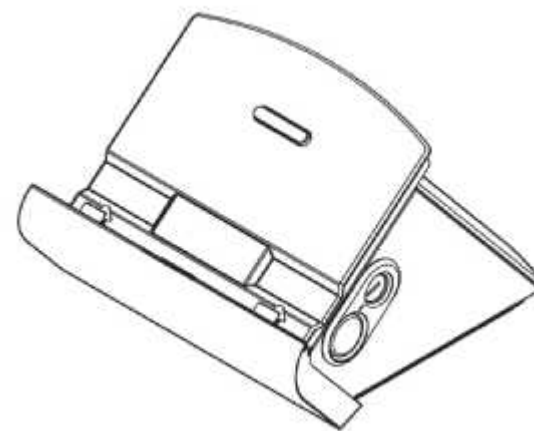

- (21) Design Number: **11737/2014**  
(22) Date of Filing Application: **07 April 2014**  
(24) Date from which industrial property rights may have effect: **07 April 2014**  
(54) Product in respect of which the design is registered: **Embossed tissue paper**  
(51) International Design Classification: **05-06NES**  
(74) Name(s) of Attorney(s):  
(71) Name(s) and Address(s) of Applicant(s):  
**GLOBAL TRADING COMPANY PTY LTD**  
**c/- Bill Li & Co PO BOX K394 Haymarket NSW 1240 Australia**  
(72) Name(s) of Designer(s): **Chia Chieh Chang**  
(45) Registration Date: **02 May 2014**  
(56) Related Art Documents: **Not Applicable**  
(57) Statement of Newness and Distinctiveness: **Newness and distinctiveness reside in the features of pattern and ornamentation applicable to an embossed tissue of the design as shown in the representations.**

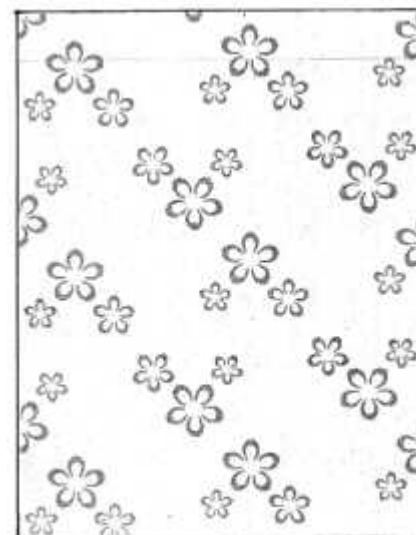



(21) Design Number: **11740/2014**  
(22) Date of Filing Application: **07 April 2014**  
(24) Date from which industrial property rights may have effect: **07 April 2014**  
(54) Product in respect of which the design is registered: **Towing mirror clamp**  
(51) International Design Classification: **12-16H**  
(74) Name(s) of Attorney(s): **Murray Trento & Associates**  
(71) Name(s) and Address(s) of Applicant(s):  
**Milenco Limited**  
**Blackhill Drive Wolverton Mill Milton Keynes Buckinghamshire MK12**  
**5TS United Kingdom**  
(72) Name(s) of Designer(s): **Frederick Nigel Milbank**  
(45) Registration Date: **02 May 2014**  
(30) Convention priority data:  
(31) Number (32) Date (33) Country  
**002322966 09 Oct 2013 OFFICE FOR HARMONISATION IN**  
**THE INTERNAL MARKET (OHIM)**  
(56) Related Art Documents: **Not Applicable**  
(57) Statement of Newness and Distinctiveness: **Nil**

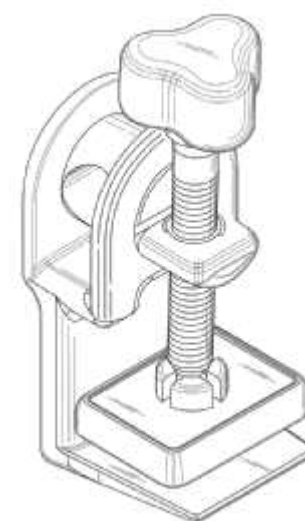

(21) Design Number: **10255/2014**  
(22) Date of Filing Application: **21 January 2014**  
(24) Date from which industrial property rights may have effect: **21 January 2014**  
(54) Product in respect of which the design is registered: **Dressing**  
(51) International Design Classification: **24-04**  
(74) Name(s) of Attorney(s): **Davies Collison Cave**  
(71) Name(s) and Address(s) of Applicant(s):  
**3M Innovative Properties Company**  
**3M Center Saint Paul Minnesota 55133-3427 United States of America**  
(72) Name(s) of Designer(s): **John W Longaback and Scott M Lecy and**  
**Christopher J Claypool and Todd L Nelson and Theodore P Peichel and**  
**Donald G Peterson and Mark A Peltier**  
(45) Registration Date: **05 May 2014**  
(30) Convention priority data:  
(31) Number (32) Date (33) Country  
**29/461434 23 Jul 2013 UNITED STATES OF AMERICA**  
(56) Related Art Documents: **Not Applicable**  
(57) Statement of Newness and Distinctiveness: **Newness and distinctiveness is**  
**claimed in the visual features shown in solid lines in the representations.**  
**In considering the extent of the design rights, the broken lines shown**  
**in the representations are for illustrative purposes only and do not form**  
**part of the design.**

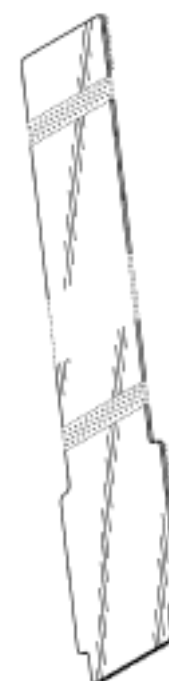

- (21) Design Number: **11092/2014**  
(22) Date of Filing Application: **10 March 2014**  
(24) Date from which industrial property rights may have effect: **10 March 2014**  
(54) Product in respect of which the design is registered: **A Dual Compartment Wipe Dispenser**  
(51) International Design Classification: **07-99C**  
(74) Name(s) of Attorney(s):  
(71) Name(s) and Address(s) of Applicant(s):  
**Wayne Desmond Burgis**  
**c/- Michael Buck IP PO BOX 4361 St Lucia QLD 4067 Australia**  
(72) Name(s) of Designer(s): **Darryl John Lanyon**  
(45) Registration Date: **05 May 2014**  
(56) Related Art Documents: **Not Applicable**  
(57) Statement of Newness and Distinctiveness: **The shape and configuration of a dual compartment wipe dispenser as depicted in the accompanying representations.**



- (21) Design Number: **11110/2014**  
(22) Date of Filing Application: **11 March 2014**  
(24) Date from which industrial property rights may have effect: **11 March 2014**  
(54) Product in respect of which the design is registered: **Pendant light fixture**  
(51) International Design Classification: **26-05D**  
(74) Name(s) of Attorney(s):  
(71) Name(s) and Address(s) of Applicant(s):  
**Duncan James Fraser Ward**  
**96 Hudsons Rd Spotswood VIC 3015 Australia**  
(72) Name(s) of Designer(s): **Duncan James Fraser Ward**  
(45) Registration Date: **05 May 2014**  
(56) Related Art Documents: **Not Applicable**  
(57) Statement of Newness and Distinctiveness: **The newness and distinctiveness of the design resides in the way the blades are interlocked and suspended from the horizontal ring of the fitting. This is achieved by slotting the individual blade through the suspended ring to create a saw tooth design. The blade pattern can be changed to create a different pattern or blades can be removed from the design to create a single layer. The shape of the blade will also vary to create different patterns when arrayed around the design.**

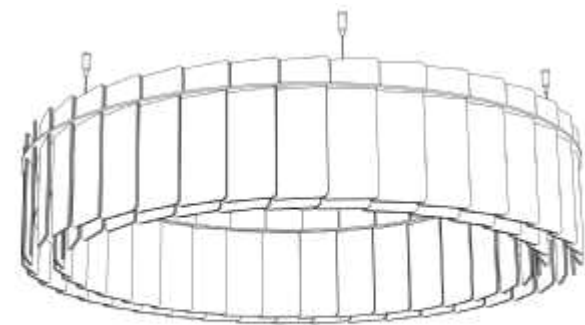

- (21) Design Number: **11111/2014**  
(22) Date of Filing Application: **11 March 2014**  
(24) Date from which industrial property rights may have effect: **11 March 2014**  
(54) Product in respect of which the design is registered: **Pendant light fitting**  
(51) International Design Classification: **26-05D**  
(74) Name(s) of Attorney(s):  
(71) Name(s) and Address(s) of Applicant(s):  
**Duncan James Fraser Ward**  
**96 Hudsons Rd Spotswood VIC 3015 Australia**  
(72) Name(s) of Designer(s): **Duncan James Fraser Ward**  
(45) Registration Date: **05 May 2014**  
(56) Related Art Documents: **Not Applicable**  
(57) Statement of Newness and Distinctiveness: **The newness and distinctiveness of the design resides in the way the blades are interlocked and suspended from the horizontal ring of the fitting. This is achieved by slotting the individual blade through the suspended ring to create a picket fence design. The blade pattern can be changed to create a different pattern or blades can be removed from the design to create a single layer. The shape of the blade can also vary to create different patterns when arrayed around the design.**

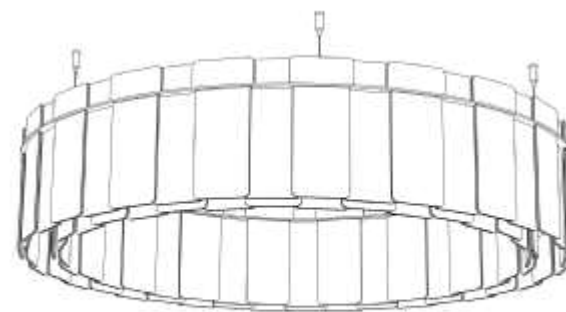

- (21) Design Number: **11378/2014**  
(22) Date of Filing Application: **25 March 2014**  
(24) Date from which industrial property rights may have effect: **25 March 2014**  
(54) Product in respect of which the design is registered: **Sprinkler base**  
(51) International Design Classification: **23-01D**  
(74) Name(s) of Attorney(s): **FB Rice**  
(71) Name(s) and Address(s) of Applicant(s):  
**Kathleen Patricia Holmes**  
**3 Reserve Rd WANGI WANGI NSW 2267**  
(72) Name(s) of Designer(s): **Kathy Holmes**  
(45) Registration Date: **05 May 2014**  
(56) Related Art Documents: **Not Applicable**  
(57) Statement of Newness and Distinctiveness: **Newness and distinctiveness reside in the features of shape and configuration of the article illustrated in the representations.**

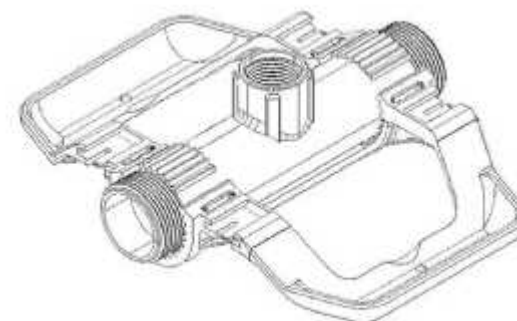

- (21) Design Number: **11613/2014**  
(22) Date of Filing Application: **01 April 2014**  
(24) Date from which industrial property rights may have effect: **01 April 2014**  
(54) Product in respect of which the design is registered: **Plastic crate**  
(51) International Design Classification: **09-04**  
(74) Name(s) of Attorney(s):  
(71) Name(s) and Address(s) of Applicant(s):



- Warren John Scott**  
**PO BOX 281 Hornsby NSW 1630 Australia**  
(72) Name(s) of Designer(s): **Warren John Scott**  
(45) Registration Date: **05 May 2014**  
(56) Related Art Documents: **Not Applicable**  
(57) Statement of Newness and Distinctiveness: **The newness and distinctiveness of the design resides in the fact that the crate caters in size for a home use recycling vessel that can increase in capacity when required. This increase in capacity is achieved by holding steady the base crate using the foot panels and lifting out the internal crate until it clicks into position.**

- (21) Design Number: **11768/2014**  
(22) Date of Filing Application: **09 April 2014**  
(24) Date from which industrial property rights may have effect: **09 April 2014**  
(54) Product in respect of which the design is registered: **Shoe**  
(51) International Design Classification: **02-04NES**  
(74) Name(s) of Attorney(s): **WATERMARK PATENT AND TRADE MARKS ATTORNEYS**  
(71) Name(s) and Address(s) of Applicant(s):



- Emu Ridge Holdings Pty Ltd**  
**77 Barwon Tce South Geelong VIC 3220 Australia**  
(72) Name(s) of Designer(s): **Paul David Neate**  
(45) Registration Date: **05 May 2014**  
(56) Related Art Documents: **Not Applicable**  
(57) Statement of Newness and Distinctiveness: **Newness and distinctiveness resides in the features of shape and/or configuration of a shoe as shown in the accompanying representations. The text appearing on the insole of the shoe, and the logo appearing on the side of the shoe, do not form part of the design.**

(21) Design Number: **11770/2014**  
(22) Date of Filing Application: **09 April 2014**  
(24) Date from which industrial property rights may have effect: **09 April 2014**  
(54) Product in respect of which the design is registered: **Helmet**  
(51) International Design Classification: **02-03**  
(74) Name(s) of Attorney(s):  
(71) Name(s) and Address(s) of Applicant(s):  
**Clay Edward James Caird**  
**733 Maddisons Road RD 5 Christchurch 7675 New Zealand**  
(72) Name(s) of Designer(s): **Clay Edward James Caird**  
(45) Registration Date: **05 May 2014**  
(30) Convention priority data:  
(31) Number (32) Date (33) Country  
**4033567 03 Jan 2014 UNITED KINGDOM**  
(56) Related Art Documents: **Not Applicable**  
(57) Statement of Newness and Distinctiveness: **Newness and distinctiveness resides in the shape, configuration and ornamentation of a Pith helmet as shown in the representations.**



(21) Design Number: **11771/2014**  
(22) Date of Filing Application: **09 April 2014**  
(24) Date from which industrial property rights may have effect: **09 April 2014**  
(54) Product in respect of which the design is registered: **Insulating structural stud**  
(51) International Design Classification: **25-01C**  
(74) Name(s) of Attorney(s): **AJ Park**  
(71) Name(s) and Address(s) of Applicant(s):  
**Dennis Edmondson**  
**4027 80 St NE Marysville Washington 98370 US**  
(72) Name(s) of Designer(s): **Dennis Edmondson**  
(45) Registration Date: **05 May 2014**  
(30) Convention priority data:  
(31) Number (32) Date (33) Country  
**29/469,275 09 Oct 2013 UNITED STATES OF AMERICA**  
(56) Related Art Documents: **Not Applicable**  
(57) Statement of Newness and Distinctiveness: **Newness and distinctiveness reside in the features of shape and/or configuration of the Insulating structural stud as shown in the representations.**

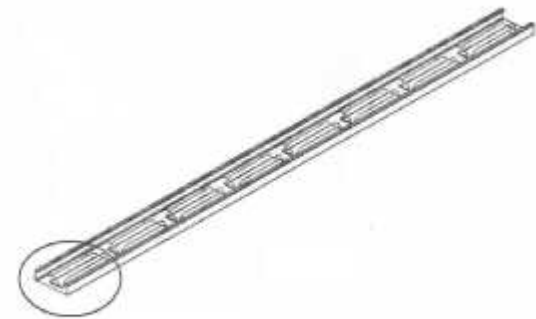

(21) Design Number: **11773/2014**  
(22) Date of Filing Application: **09 April 2014**  
(24) Date from which industrial property rights may have effect: **09 April 2014**  
(54) Product in respect of which the design is registered: **Boot**  
(51) International Design Classification: **02-04NES**  
(74) Name(s) of Attorney(s): **WATERMARK PATENT AND TRADE MARKS ATTORNEYS**  
(71) Name(s) and Address(s) of Applicant(s):  
**Emu Ridge Holdings Pty Ltd**  
**77 Barwon Tce South Geelong VIC 3220 Australia**  
(72) Name(s) of Designer(s): **Paul David Neate**  
(45) Registration Date: **05 May 2014**  
(56) Related Art Documents: **Not Applicable**  
(57) Statement of Newness and Distinctiveness: **Newness and distinctiveness resides in the features of shape and/or configuration of a boot as shown in the accompanying representations. The logo appearing on the side of the boot does not form part of the design.**



(21) Design Number: **11778/2014**  
(22) Date of Filing Application: **10 April 2014**  
(24) Date from which industrial property rights may have effect: **10 April 2014**  
(54) Product in respect of which the design is registered: **Pillow**  
(51) International Design Classification: **06-13B, 06-09**  
(74) Name(s) of Attorney(s): **PHILLIPS ORMONDE FITZPATRICK**  
(71) Name(s) and Address(s) of Applicant(s):  
**Standard Fiber LLC**  
**577 Airport Boulevard Burlingame California 94010 United States of America**  
(72) Name(s) of Designer(s): **W Alexander Gray III and Russ Holbrook**  
(45) Registration Date: **05 May 2014**  
(30) Convention priority data:  
(31) Number      (32) Date      (33) Country  
**29/471,637      04 Nov 2013      UNITED STATES OF AMERICA**  
(56) Related Art Documents: **Not Applicable**  
(57) Statement of Newness and Distinctiveness: **Those features of the pillow depicted in the representations that are new and distinctive are the shape and/or configuration.**



(21) Design Number: **11779/2014**

(22) Date of Filing Application: **10 April 2014**

(24) Date from which industrial property rights may have effect: **10 April 2014**

(54) Product in respect of which the design is registered: **Suction Nozzle**

(51) International Design Classification: **15-05**

(74) Name(s) of Attorney(s): **Callinans**

(71) Name(s) and Address(s) of Applicant(s):

**Wessel-Werk GmbH**

**Im Bruch 2 Reichshof-Wildbergerhutte 51580 Germany**

(72) Name(s) of Designer(s): **Martin Zydek**

(45) Registration Date: **05 May 2014**

(30) Convention priority data:

(31) Number

(32) Date

(33) Country

**002351007-001**

**25 Nov 2013**

**OFFICE FOR HARMONISATION IN  
THE INTERNAL MARKET (OHIM)**

(56) Related Art Documents: **Not Applicable**

(57) Statement of Newness and Distinctiveness: **Newness and distinctiveness resides in the features of shape and configuration as applied to a suction nozzle as shown in the accompanying representations.**



(21) Design Number: **11780/2014**

(22) Date of Filing Application: **10 April 2014**

(24) Date from which industrial property rights may have effect: **10 April 2014**

(54) Product in respect of which the design is registered: **Cover for suction nozzle**

(51) International Design Classification: **15-05**

(74) Name(s) of Attorney(s): **Callinans**

(71) Name(s) and Address(s) of Applicant(s):

**Wessel-Werk GmbH**

**Im Bruch 2 Reichshof-Wildbergerhutte 51580 Germany**

(72) Name(s) of Designer(s): **Martin Zydek**

(45) Registration Date: **05 May 2014**

(30) Convention priority data:

(31) Number

(32) Date

(33) Country

**002351007-0002**

**25 Nov 2013**

**OFFICE FOR HARMONISATION IN  
THE INTERNAL MARKET (OHIM)**

(56) Related Art Documents: **Not Applicable**

(57) Statement of Newness and Distinctiveness: **Newness and distinctiveness resides in the features of shape and configuration as applied to a cover for a suction nozzle as shown in the accompanying representations. Features shown in phantom do not constitute part of the design.**



(21) Design Number: **11781/2014**  
(22) Date of Filing Application: **10 April 2014**  
(24) Date from which industrial property rights may have effect: **10 April 2014**  
(54) Product in respect of which the design is registered: **Cover for suction nozzle**  
(51) International Design Classification: **15-05**  
(74) Name(s) of Attorney(s): **Callinans**  
(71) Name(s) and Address(s) of Applicant(s):  
**Wessel-Werk GmbH**  
**Im Bruch 2 Reichshof-Wildbergerhutte 51580 Germany**  
(72) Name(s) of Designer(s): **Martin Zydek**  
(45) Registration Date: **05 May 2014**  
(30) Convention priority data:  
(31) Number (32) Date (33) Country  
**002351007-0003 25 Nov 2013 OFFICE FOR HARMONISATION IN**  
**THE INTERNAL MARKET (OHIM)**



(56) Related Art Documents: **Not Applicable**  
(57) Statement of Newness and Distinctiveness: **Newness and distinctiveness resides in the Application of the features of pattern and ornamentation to a cover for a suction nozzle cover as shown in the accompanying representations. Features shown in phantom lines do not constitute part of the design**

(21) Design Number: **11782/2014**  
(22) Date of Filing Application: **10 April 2014**  
(24) Date from which industrial property rights may have effect: **10 April 2014**  
(54) Product in respect of which the design is registered: **Cover for a suction nozzle**  
(51) International Design Classification: **15-05**  
(74) Name(s) of Attorney(s): **Callinans**  
(71) Name(s) and Address(s) of Applicant(s):  
**Wessel-Werk GmbH**  
**Im Bruch 2 Reichshof-Wildbergerhutte 51580 Germany**  
(72) Name(s) of Designer(s): **Martin Zydek**  
(45) Registration Date: **05 May 2014**  
(30) Convention priority data:  
(31) Number (32) Date (33) Country  
**002351007-0004 25 Nov 2013 OFFICE FOR HARMONISATION IN**  
**THE INTERNAL MARKET (OHIM)**



(56) Related Art Documents: **Not Applicable**  
(57) Statement of Newness and Distinctiveness: **Newness and distinctiveness resides in the Application of the features of pattern and ornamentation to a cover for a suction nozzle as shown in the accompanying representations. Features shown in phantom lines do not constitute part of the design**

(21) Design Number: **11783/2014**  
(22) Date of Filing Application: **10 April 2014**  
(24) Date from which industrial property rights may have effect: **10 April 2014**  
(54) Product in respect of which the design is registered: **Cover for suction nozzle**  
(51) International Design Classification: **15-05**  
(74) Name(s) of Attorney(s): **Callinans**  
(71) Name(s) and Address(s) of Applicant(s):

**Wessel-Werk GmbH**  
**Im Bruch 2 Reichshof-Wildbergerhutte 51580 Germany**

(72) Name(s) of Designer(s): **Martin Zydek**

(45) Registration Date: **05 May 2014**

(30) Convention priority data:

(31) Number	(32) Date	(33) Country
<b>2351007-0004</b>	<b>25 Nov 2013</b>	<b>OFFICE FOR HARMONISATION IN THE INTERNAL MARKET (OHIM)</b>



(56) Related Art Documents: **Not Applicable**

(57) Statement of Newness and Distinctiveness: **Newness and distinctiveness resides in the Application of the features of pattern and ornamentation to a cover for a suction nozzle as shown in the accompanying representations. Features shown in phantom lines do not constitute part of the design**

(21) Design Number: **16557/2013**  
(22) Date of Filing Application: **16 December 2013**  
(24) Date from which industrial property rights may have effect: **16 December 2013**  
(54) Product in respect of which the design is registered: **Holder for a burnable substrate**  
(51) International Design Classification: **22-06**  
(74) Name(s) of Attorney(s): **SPRUSON & FERGUSON**  
(71) Name(s) and Address(s) of Applicant(s):

**S. C. Johnson & Son, Inc.**  
**1525 Howe Street Racine Wisconsin 53403 United States of America**

(72) Name(s) of Designer(s): **Mark W. Geis**

(45) Registration Date: **05 May 2014**

(30) Convention priority data:

(31) Number	(32) Date	(33) Country
<b>29/458399</b>	<b>19 Jun 2013</b>	<b>UNITED STATES OF AMERICA</b>

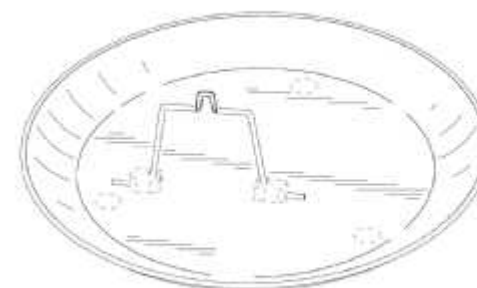

(56) Related Art Documents: **Not Applicable**

(57) Statement of Newness and Distinctiveness: **Newness and distinctiveness is claimed in those features of shape and/or configuration of a holder for a burnable substrate illustrated in continuous lines in the accompanying representations.**

(21) Design Number: **10016/2014**  
(22) Date of Filing Application: **03 January 2014**  
(24) Date from which industrial property rights may have effect: **03 January 2014**  
(54) Product in respect of which the design is registered: **A mattress**  
(51) International Design Classification: **06-09**  
(74) Name(s) of Attorney(s): **Madderns**  
(71) Name(s) and Address(s) of Applicant(s):



**Bruno Daeseleire**  
**Van Halmaelelei 51 Brasschaat 2930 Belgium**

(72) Name(s) of Designer(s): **Bruno Daeseleire**

(45) Registration Date: **05 May 2014**

(30) Convention priority data:

(31) Number	(32) Date	(33) Country
<b>002267716-0001</b>	<b>03 Jul 2013</b>	<b>OFFICE FOR HARMONISATION IN THE INTERNAL MARKET (OHIM)</b>

(56) Related Art Documents: **Not Applicable**

(57) Statement of Newness and Distinctiveness: **Nil**

(21) Design Number: **11429/2014**  
(22) Date of Filing Application: **26 March 2014**  
(24) Date from which industrial property rights may have effect: **26 March 2014**  
(54) Product in respect of which the design is registered: **Hanger for an end cap**  
(51) International Design Classification: **20-02E**  
(74) Name(s) of Attorney(s): **SPRUSON & FERGUSON**  
(71) Name(s) and Address(s) of Applicant(s):

**Mid-West Metal Products Co., Inc.**  
**PO Box 1031, Muncie Indiana 47308 United States of America**

(72) Name(s) of Designer(s): **Terrance L Jones and Stew Kerr and Brad Cantwell and Michael E Greene**

(45) Registration Date: **05 May 2014**

(30) Convention priority data:

(31) Number	(32) Date	(33) Country
<b>29/468271</b>	<b>27 Sep 2013</b>	<b>UNITED STATES OF AMERICA</b>

(56) Related Art Documents: **Not Applicable**

(57) Statement of Newness and Distinctiveness: **Newness and distinctiveness is claimed in the features of shape and/or configuration of a hanger for an end cap as illustrated in the accompanying representations.**

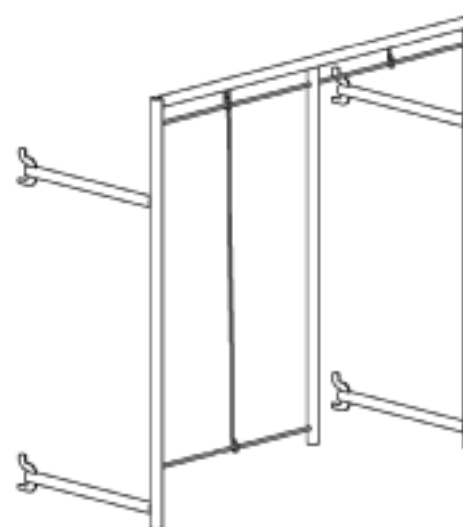

- (21) Design Number: **11758/2014**  
(22) Date of Filing Application: **08 April 2014**  
(24) Date from which industrial property rights may have effect: **08 April 2014**  
(54) Product in respect of which the design is registered: **Grill for an ice machine**  
(51) International Design Classification: **15-07**  
(74) Name(s) of Attorney(s): **IP Gateway Patent & Trademark Attorneys Pty Ltd**  
(71) Name(s) and Address(s) of Applicant(s):  
**Manitowoc Foodservice Companies, LLC**  
**2400 South 44th Street Manitowoc Wisconsin 54220 United States of America**  
(72) Name(s) of Designer(s): **Zhang Lei and Zhou Xiangcheng and Gu Zhimei and Gorm Bressner**  
(45) Registration Date: **05 May 2014**  
(30) Convention priority data:  
(31) Number (32) Date (33) Country  
**29/469,380 09 Oct 2013 UNITED STATES OF AMERICA**  
(56) Related Art Documents: **Not Applicable**  
(57) Statement of Newness and Distinctiveness: **Newness and distinctiveness reside in the features of shape and/or configuration of the grill of an ice machine as shown in solid lines in the representations. Those features shown in broken lines are for environmental purposes only and form no part of the design.**

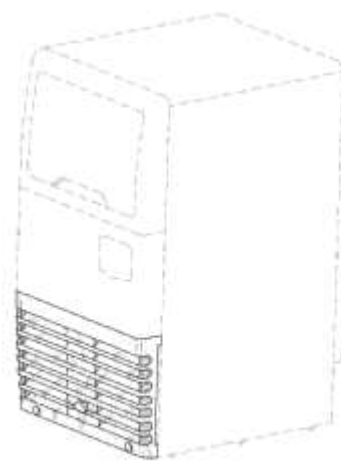

- (21) Design Number: **11759/2014**  
(22) Date of Filing Application: **08 April 2014**  
(24) Date from which industrial property rights may have effect: **08 April 2014**  
(54) Product in respect of which the design is registered: **Ice machine**  
(51) International Design Classification: **15-07**  
(74) Name(s) of Attorney(s): **IP Gateway Patent & Trademark Attorneys Pty Ltd**  
(71) Name(s) and Address(s) of Applicant(s):  
**Manitowoc Foodservice Companies, LLC**  
**2400 South 44th Street Manitowoc Wisconsin 54220 United States of America**  
(72) Name(s) of Designer(s): **Zhang Lei and Zhou Xiangcheng and Gu Zhimei and Gorm Bressner**  
(45) Registration Date: **05 May 2014**  
(30) Convention priority data:  
(31) Number (32) Date (33) Country  
**29/469,380 09 Oct 2013 UNITED STATES OF AMERICA**  
(56) Related Art Documents: **Not Applicable**  
(57) Statement of Newness and Distinctiveness: **Newness and distinctiveness reside in the features of shape and/or configuration of an ice machine as shown in solid lines in the representations. Those features shown in broken lines are to be given minimal emphasis when considering the overall impression of the design.**

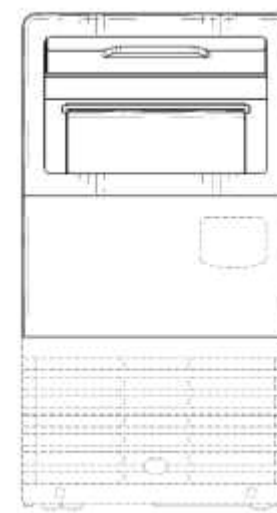

- (21) Design Number: **11760/2014**  
(22) Date of Filing Application: **08 April 2014**  
(24) Date from which industrial property rights may have effect: **08 April 2014**  
(54) Product in respect of which the design is registered: **Post box**  
(51) International Design Classification: **25-03**  
(74) Name(s) of Attorney(s):  
(71) Name(s) and Address(s) of Applicant(s):  
**Dylan James Lake**  
**17 The Rise Glen Waverley VIC 3150 Australia**  
(72) Name(s) of Designer(s): **Dylan James Lake**  
(45) Registration Date: **05 May 2014**  
(56) Related Art Documents: **Not Applicable**  
(57) Statement of Newness and Distinctiveness: **The newness and distinctiveness of the design resides in the shape and/or configuration of a letterbox shown in the representations.**

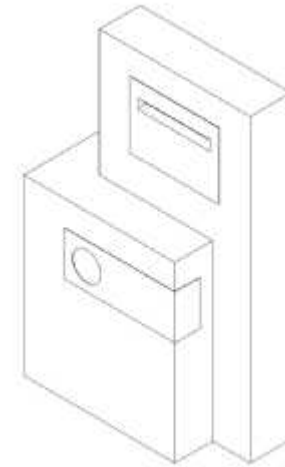

- (21) Design Number: **11761/2014**  
(22) Date of Filing Application: **08 April 2014**  
(24) Date from which industrial property rights may have effect: **08 April 2014**  
(54) Product in respect of which the design is registered: **Caulking gun**  
(51) International Design Classification: **08-05NES**  
(74) Name(s) of Attorney(s):  
(71) Name(s) and Address(s) of Applicant(s):  
**AUSTRALIAN BRUSHWARE CORPORATION PTY LTD**  
**143-147 National Bvd Campbellfield VIC 3061 Australia**  
(72) Name(s) of Designer(s): **Matthew Roe**  
(45) Registration Date: **05 May 2014**  
(56) Related Art Documents: **Not Applicable**  
(57) Statement of Newness and Distinctiveness: **Nil**



(21) Design Number: **11762/2014**  
(22) Date of Filing Application: **09 April 2014**  
(24) Date from which industrial property rights may have effect: **09 April 2014**  
(54) Product in respect of which the design is registered: **Multiple rivet driver for a power tool**  
(51) International Design Classification: **08-05P**  
(74) Name(s) of Attorney(s): **SPRUSON & FERGUSON**  
(71) Name(s) and Address(s) of Applicant(s):  
**Flexible Steel Lacing Company**  
**2525 Wisconsin Avenue, Downers Grove Illinois, 60515 United States of America**  
(72) Name(s) of Designer(s): **Pan Yim Ng and David Allen Lotarski**  
(45) Registration Date: **05 May 2014**  
(30) Convention priority data:  
(31) Number (32) Date (33) Country  
**29/469591 11 Oct 2013 UNITED STATES OF AMERICA**  
(56) Related Art Documents: **Not Applicable**  
(57) Statement of Newness and Distinctiveness: **Newness and distinctiveness is claimed in the features of shape and/or configuration of a multiple rivet driver for a power tool as illustrated in the accompanying representations.**

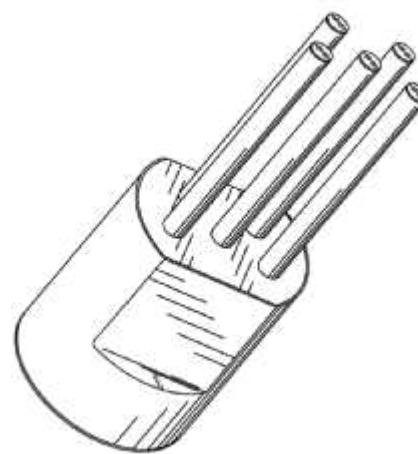

(21) Design Number: **11763/2014**  
(22) Date of Filing Application: **09 April 2014**  
(24) Date from which industrial property rights may have effect: **09 April 2014**  
(54) Product in respect of which the design is registered: **Paint spray gun**  
(51) International Design Classification: **08-05L**  
(74) Name(s) of Attorney(s): **Griffith Hack**  
(71) Name(s) and Address(s) of Applicant(s):  
**Hsing-Tzu Wang**  
**80 Ta-Hsin St Hsi Dist Taichung City Taiwan**  
(72) Name(s) of Designer(s): **Hsing-Tzu Wang**  
(45) Registration Date: **05 May 2014**  
(56) Related Art Documents: **Not Applicable**  
(57) Statement of Newness and Distinctiveness: **Newness and distinctiveness resides in the visual features, including the shape and configuration of the product shown in the representations.**



- (21) Design Number: **11765/2014**  
(22) Date of Filing Application: **09 April 2014**  
(24) Date from which industrial property rights may have effect: **09 April 2014**  
(54) Product in respect of which the design is registered: **Paint spray gun**  
(51) International Design Classification: **08-05L**  
(74) Name(s) of Attorney(s): **Freehills Patent Attorneys**  
(71) Name(s) and Address(s) of Applicant(s):  
**Hsing-Tzu Wang**  
**No. 80, Ta-Hsin St. Hsi Dist. Taichung City, 40344 Taiwan**  
(72) Name(s) of Designer(s): **Hsing-Tzu Wang**  
(45) Registration Date: **05 May 2014**  
(56) Related Art Documents: **Not Applicable**  
(57) Statement of Newness and Distinctiveness: **Newness and distinctiveness resides in the features of shape and configuration of a paint spray gun as shown in solid outline in the accompanying representations.**

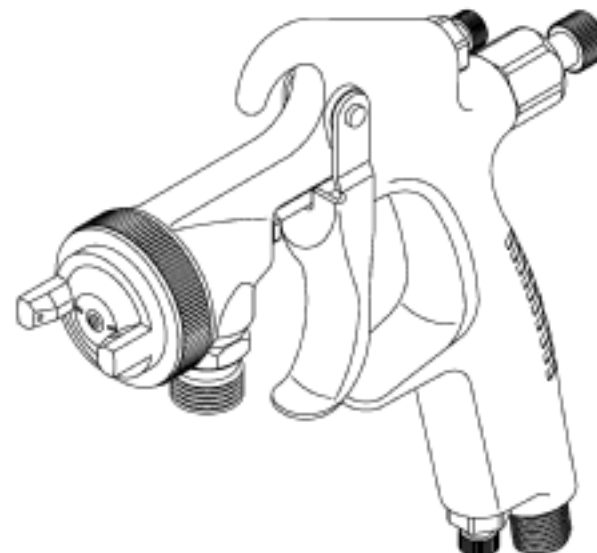

- (21) Design Number: **10081/2014**  
(22) Date of Filing Application: **10 January 2014**  
(24) Date from which industrial property rights may have effect: **10 January 2014**  
(54) Product in respect of which the design is registered: **A planter**  
(51) International Design Classification: **11-02B**  
(74) Name(s) of Attorney(s):  
(71) Name(s) and Address(s) of Applicant(s):  
**Patrick Morris**  
**46 Tongue Farm Road Matakana New Zealand**  
(72) Name(s) of Designer(s): **Patrick Morris**  
(45) Registration Date: **06 May 2014**  
(30) Convention priority data:  
(31) Number      (32) Date      (33) Country  
**417807      18 Jul 2013      NEW ZEALAND**  
(56) Related Art Documents: **Not Applicable**  
(57) Statement of Newness and Distinctiveness: **Newness and distinctiveness resides in the features of shape shown in the images.**



(21) Design Number: **10085/2014**  
(22) Date of Filing Application: **10 January 2014**  
(24) Date from which industrial property rights may have effect: **10 January 2014**  
(54) Product in respect of which the design is registered: **Air dryer**  
(51) International Design Classification: **28-03B**  
(74) Name(s) of Attorney(s): **Pizzeys**  
(71) Name(s) and Address(s) of Applicant(s):  
**Dri-Eaz Products, Inc.**  
**15180 Josh Wilson Road Burlington WA 98233 United States of America**  
(72) Name(s) of Designer(s): **Ryan A. Kulp and Richard A. Black and Larry White**  
(45) Registration Date: **06 May 2014**  
(30) Convention priority data:  
(31) Number (32) Date (33) Country  
**29/460,434 10 Jul 2013 UNITED STATES OF AMERICA**  
(56) Related Art Documents: **Not Applicable**  
(57) Statement of Newness and Distinctiveness: **Nil**



(21) Design Number: **10191/2014**  
(22) Date of Filing Application: **17 January 2014**  
(24) Date from which industrial property rights may have effect: **17 January 2014**  
(54) Product in respect of which the design is registered: **Rear lighting strip**  
(51) International Design Classification: **26-06, 13-02**  
(74) Name(s) of Attorney(s): **WATERMARK PATENT AND TRADE MARKS ATTORNEYS**  
(71) Name(s) and Address(s) of Applicant(s):  
**Steven Ransom**  
**Half Acre Battsbridge Road Maresfield Uckfield TN22 2HJ United Kingdom**  
(72) Name(s) of Designer(s): **Steven Ransom**  
(45) Registration Date: **06 May 2014**  
(30) Convention priority data:  
(31) Number (32) Date (33) Country  
**002317198-0001 27 Sep 2013 EUROPEAN PATENT OFFICE (EPO)**  
(56) Related Art Documents: **Not Applicable**  
(57) Statement of Newness and Distinctiveness: **Nil**

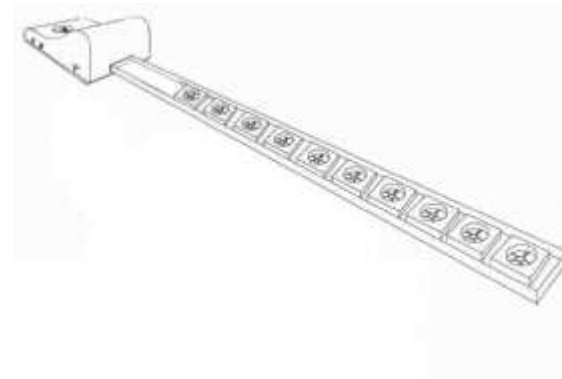

(21) Design Number: **10195/2014**  
(22) Date of Filing Application: **17 January 2014**  
(24) Date from which industrial property rights may have effect: **17 January 2014**  
(54) Product in respect of which the design is registered: **Television receiver**  
(51) International Design Classification: **14-03B**  
(74) Name(s) of Attorney(s): **FB Rice**  
(71) Name(s) and Address(s) of Applicant(s):  
**LG Electronics Inc.**  
**128 Yeoui-daero Yeongdeungpo-gu Seoul 150-721 Republic of Korea**  
(72) Name(s) of Designer(s): **Jongchul Kim and Jiyeon Lee**  
(45) Registration Date: **06 May 2014**  
(30) Convention priority data:  
(31) Number (32) Date (33) Country  
**30-2014-0000872 07 Jan 2014 REPUBLIC OF KOREA**  
(56) Related Art Documents: **Not Applicable**  
(57) Statement of Newness and Distinctiveness: **Newness and distinctiveness reside in the features of shape and configuration of the design as shown in the representations, and excluding those features shown in broken lines.**

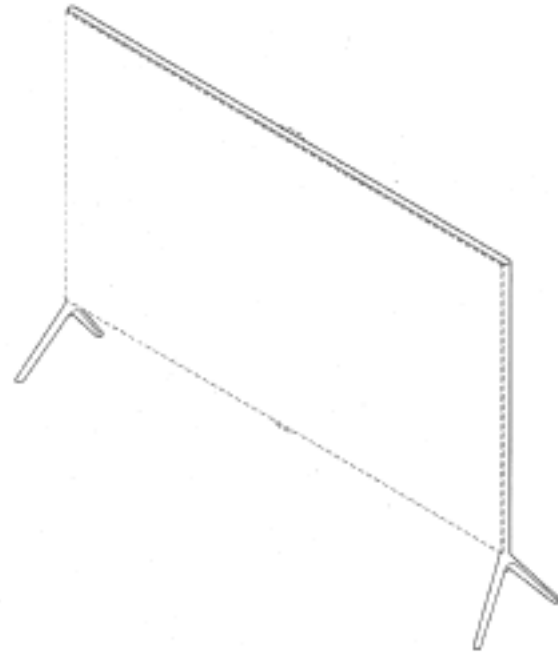

(21) Design Number: **10397/2014**  
(22) Date of Filing Application: **29 January 2014**  
(24) Date from which industrial property rights may have effect: **29 January 2014**  
(54) Product in respect of which the design is registered: **Massage shoe**  
(51) International Design Classification: **02-04NES**  
(74) Name(s) of Attorney(s): **PHILLIPS ORMONDE FITZPATRICK**  
(71) Name(s) and Address(s) of Applicant(s):  
**Yaffa Golan**  
**59 Pinsker Street Tel Aviv 63568 Israel**  
(72) Name(s) of Designer(s): **Yaffa Golan**  
(45) Registration Date: **06 May 2014**  
(30) Convention priority data:  
(31) Number (32) Date (33) Country  
**54395 29 Jul 2013 ISRAEL**  
(56) Related Art Documents: **Not Applicable**  
(57) Statement of Newness and Distinctiveness: **Nil**

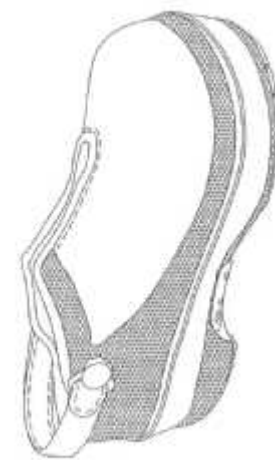

(21) Design Number: **10697/2014**  
(22) Date of Filing Application: **13 February 2014**  
(24) Date from which industrial property rights may have effect: **13 February 2014**  
(54) Product in respect of which the design is registered: **Sofa**  
(51) International Design Classification: **06-01H**  
(74) Name(s) of Attorney(s): **Armour IP**  
(71) Name(s) and Address(s) of Applicant(s):



**Tribu N.V.**  
**Langendijkstraat 5A Zutendaal 3690 Belgium**

(72) Name(s) of Designer(s): **Piergiorgio Cazzaniga**

(45) Registration Date: **06 May 2014**

(30) Convention priority data:

(31) Number	(32) Date	(33) Country
<b>002302323-0006</b>	<b>04 Sep 2013</b>	<b>OFFICE FOR HARMONISATION IN THE INTERNAL MARKET (OHIM)</b>

(56) Related Art Documents: **Not Applicable**

(57) Statement of Newness and Distinctiveness: **Nil**

(21) Design Number: **11089/2014**  
(22) Date of Filing Application: **10 March 2014**  
(24) Date from which industrial property rights may have effect: **10 March 2014**  
(54) Product in respect of which the design is registered: **A dual compartment  
wipe dispenser**  
(51) International Design Classification: **07-99C**  
(74) Name(s) of Attorney(s):  
(71) Name(s) and Address(s) of Applicant(s):

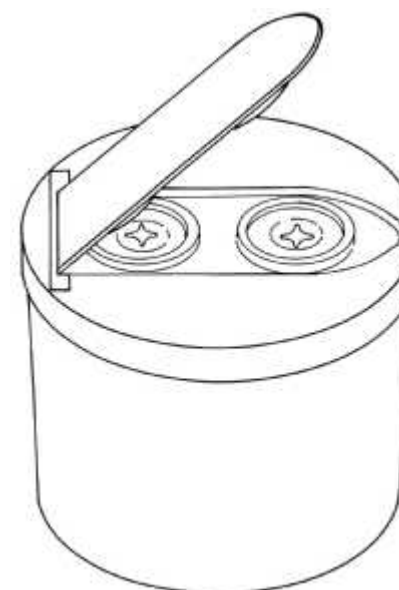

**Wayne Desmond Burgis**  
**c/- Michael Buck IP PO BOX 4361 St Lucia QLD 4067 Australia**

(72) Name(s) of Designer(s): **Darryl John Lanyon**

(45) Registration Date: **06 May 2014**

(56) Related Art Documents: **Not Applicable**

(57) Statement of Newness and Distinctiveness: **The shape and configuration  
of a dual compartment wipe dispenser as depicted in the accompanying  
representations.**

- (21) Design Number: **11090/2014**  
(22) Date of Filing Application: **10 March 2014**  
(24) Date from which industrial property rights may have effect: **10 March 2014**  
(54) Product in respect of which the design is registered: **A dual compartment wipe dispenser**  
(51) International Design Classification: **07-99C**  
(74) Name(s) of Attorney(s):  
(71) Name(s) and Address(s) of Applicant(s):  
**Wayne Desmond Burgis**  
**c/- Michael Buck IP PO BOX 4361 St Lucia QLD 4067 Australia**  
(72) Name(s) of Designer(s): **Darryl John Lanyon**  
(45) Registration Date: **06 May 2014**  
(56) Related Art Documents: **Not Applicable**  
(57) Statement of Newness and Distinctiveness: **The shape and distinctiveness of a dual compartment wipe dispenser as depicted in the accompanying representations.**

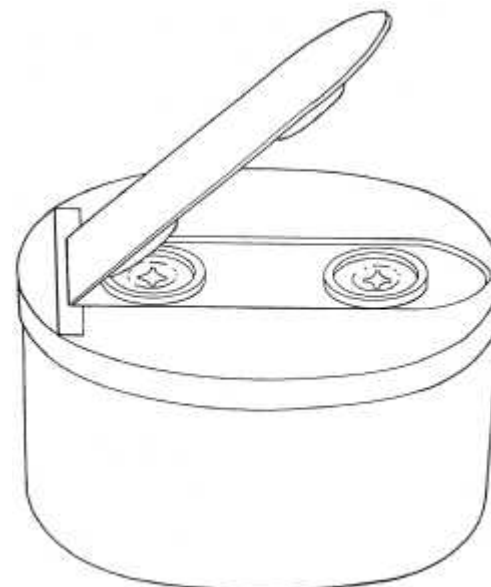

- (21) Design Number: **11091/2014**  
(22) Date of Filing Application: **10 March 2014**  
(24) Date from which industrial property rights may have effect: **10 March 2014**  
(54) Product in respect of which the design is registered: **A dual compartment wipe dispenser**  
(51) International Design Classification: **07-99C**  
(74) Name(s) of Attorney(s):  
(71) Name(s) and Address(s) of Applicant(s):  
**Wayne Desmond Burgis**  
**c/- Michael Buck IP PO BOX 4361 St Lucia QLD 4067 Australia**  
(72) Name(s) of Designer(s): **Darryl John Lanyon**  
(45) Registration Date: **06 May 2014**  
(56) Related Art Documents: **Not Applicable**  
(57) Statement of Newness and Distinctiveness: **The shape and configuration of a dual compartment wipe dispenser as depicted in the accompanying representations.**

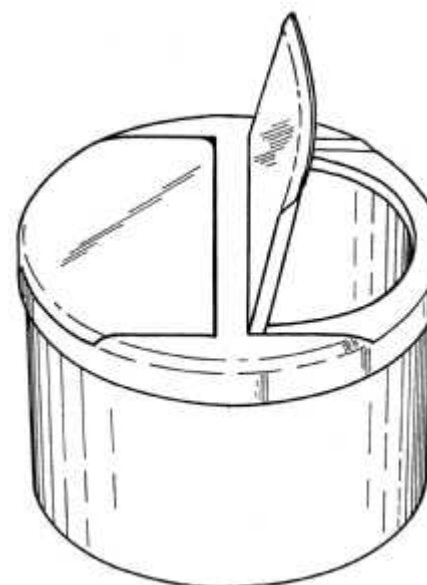

(21) Design Number: **11363/2014**  
(22) Date of Filing Application: **24 March 2014**  
(24) Date from which industrial property rights may have effect: **24 March 2014**  
(54) Product in respect of which the design is registered: **Lighting**  
(51) International Design Classification: **26-05D**  
(74) Name(s) of Attorney(s): **Pizzeys**  
(71) Name(s) and Address(s) of Applicant(s):  
**LSI Industries, Inc.**  
**10000 Alliance Road Cincinnati OH 45242 United States of America**  
(72) Name(s) of Designer(s): **John D Boyer and Daniel Hutchens and Eric Jon Mooar**  
(45) Registration Date: **06 May 2014**  
(30) Convention priority data:  
(31) Number (32) Date (33) Country  
**29/468,917 04 Oct 2013 UNITED STATES OF AMERICA**  
(56) Related Art Documents: **Not Applicable**  
(57) Statement of Newness and Distinctiveness: **Nil**

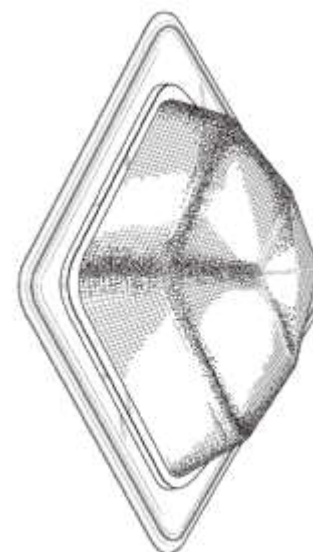

(21) Design Number: **11364/2014**  
(22) Date of Filing Application: **24 March 2014**  
(24) Date from which industrial property rights may have effect: **24 March 2014**  
(54) Product in respect of which the design is registered: **Lighting**  
(51) International Design Classification: **26-05D**  
(74) Name(s) of Attorney(s): **Pizzeys**  
(71) Name(s) and Address(s) of Applicant(s):  
**LSI Industries, Inc.**  
**10000 Alliance Road Cincinnati OH 45242 United States of America**  
(72) Name(s) of Designer(s): **John D Boyer and Daniel Hutchens and Eric Jon Mooar**  
(45) Registration Date: **06 May 2014**  
(30) Convention priority data:  
(31) Number (32) Date (33) Country  
**29/468,929 04 Oct 2013 UNITED STATES OF AMERICA**  
(56) Related Art Documents: **Not Applicable**  
(57) Statement of Newness and Distinctiveness: **Nil**

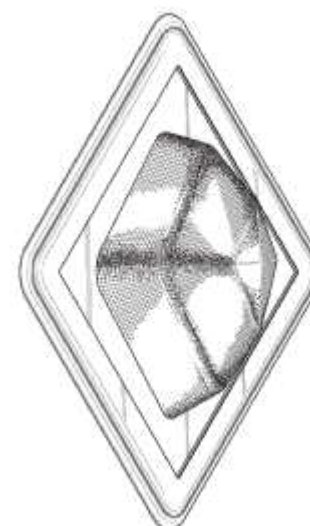

(21) Design Number: **11497/2014**

(22) Date of Filing Application: **28 March 2014**

(24) Date from which industrial property rights may have effect: **28 March 2014**

(54) Product in respect of which the design is registered: **Bottle**

(51) International Design Classification: **09-01G**

(74) Name(s) of Attorney(s): **PHILLIPS ORMONDE FITZPATRICK**

(71) Name(s) and Address(s) of Applicant(s):

**ELC Management LLC**

**155 Pinelawn Road Suite 345 South Melville New York 11747 United States of America**

(72) Name(s) of Designer(s): **Thomas Edmond Hall and Helen Lazic**

(45) Registration Date: **06 May 2014**

(30) Convention priority data:

(31) Number	(32) Date	(33) Country
<b>29/470,026</b>	<b>17 Oct 2013</b>	<b>UNITED STATES OF AMERICA</b>

(56) Related Art Documents: **Not Applicable**

(57) Statement of Newness and Distinctiveness: **Those features of the bottle depicted in the representations that are new and distinctive are the shape and/or configuration. The ovoid-shaped aperture and spray nozzle shown in broken lines are for illustrative purposes and are to be disregarded when considering the overall impression of the design.**



(21) Design Number: **11749/2014**

(22) Date of Filing Application: **08 April 2014**

(24) Date from which industrial property rights may have effect: **08 April 2014**

(54) Product in respect of which the design is registered: **Dental appliance**

(51) International Design Classification: **24-02**

(74) Name(s) of Attorney(s): **PETER MAXWELL & ASSOCIATES**

(71) Name(s) and Address(s) of Applicant(s):

**Ortho-Tain, Inc.**

**950 Green Bay Road Suite 205 Winnetka Illinois, 60093 United States of America**

(72) Name(s) of Designer(s): **Earl O Bergersen**

(45) Registration Date: **06 May 2014**

(30) Convention priority data:

(31) Number	(32) Date	(33) Country
<b>29/471,799</b>	<b>05 Nov 2013</b>	<b>UNITED STATES OF AMERICA</b>

(56) Related Art Documents: **Not Applicable**

(57) Statement of Newness and Distinctiveness: **Newness and distinctiveness is claimed in the shape and/or configuration of a DENTAL APPLIANCE as illustrated in the unbroken lines in the accompanying representations.**

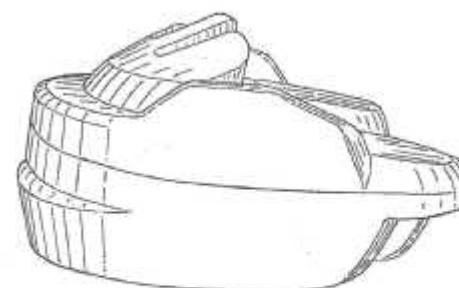

(21) Design Number: **11088/2014**  
(22) Date of Filing Application: **10 March 2014**  
(24) Date from which industrial property rights may have effect: **10 March 2014**  
(54) Product in respect of which the design is registered: **Tool box**  
(51) International Design Classification: **03-01D**  
(74) Name(s) of Attorney(s): **Davies Collison Cave**  
(71) Name(s) and Address(s) of Applicant(s):

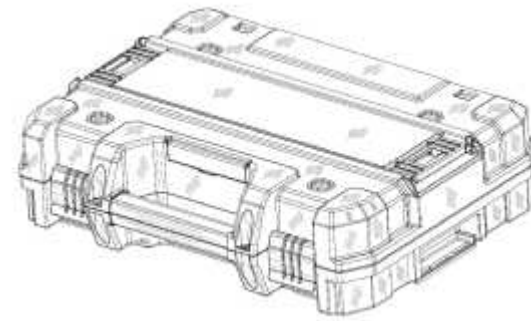

**The Stanley Works Israel Ltd.**  
**19 Ha'Melacha Street Rosh Ha'Ayin 48091 Israel**

(72) Name(s) of Designer(s): **Elad Hay Shitrit**  
(45) Registration Date: **06 May 2014**  
(30) Convention priority data:  
(31) Number (32) Date (33) Country  
**001382808-0001 10 Sep 2013 OFFICE FOR HARMONISATION IN  
THE INTERNAL MARKET (OHIM)**

(56) Related Art Documents: **Not Applicable**  
(57) Statement of Newness and Distinctiveness: **Newness and distinctiveness is  
claimed in the visual features shown in solid lines in the representations.**

(21) Design Number: **11575/2014**  
(22) Date of Filing Application: **31 March 2014**  
(24) Date from which industrial property rights may have effect: **31 March 2014**  
(54) Product in respect of which the design is registered: **Shovel**  
(51) International Design Classification: **08-01**  
(74) Name(s) of Attorney(s):  
(71) Name(s) and Address(s) of Applicant(s):



**Haigh Australia Pty Ltd**  
**64 Argyle Parade Darra Queensland 4076 Australia**

(72) Name(s) of Designer(s): **Chris Roberts**  
(45) Registration Date: **06 May 2014**  
(56) Related Art Documents: **Not Applicable**  
(57) Statement of Newness and Distinctiveness: **Newness and distinctiveness  
resides in the features of shape and/or configuration of a shovel as  
shown in the accompanying representations, in particular the D handle  
may remain in place when a handle extension is fitted.**

(21) Design Number: **11785/2014**

(22) Date of Filing Application: **10 April 2014**

(24) Date from which industrial property rights may have effect: **10 April 2014**

(54) Product in respect of which the design is registered: **Cover for suction nozzle**

(51) International Design Classification: **15-05**

(74) Name(s) of Attorney(s): **Callinans**

(71) Name(s) and Address(s) of Applicant(s):

**Wessel-Werk GmbH**

**Im Bruch 2 Reichshof-Wildbergerhutte 51580 Germany**

(72) Name(s) of Designer(s): **Martin Zydek**

(45) Registration Date: **06 May 2014**

(30) Convention priority data:

(31) Number

(32) Date

(33) Country

**002351007-0007 25 Nov 2013**

**OFFICE FOR HARMONISATION IN  
THE INTERNAL MARKET (OHIM)**

(56) Related Art Documents: **Not Applicable**

(57) Statement of Newness and Distinctiveness: **Newness and distinctiveness resides in the Application of the features of pattern and ornamentation to a cover for a suction nozzle as shown in the accompanying representations. Features shown in phantom lines do not constitute part of the design.**



(21) Design Number: **11786/2014**

(22) Date of Filing Application: **10 April 2014**

(24) Date from which industrial property rights may have effect: **10 April 2014**

(54) Product in respect of which the design is registered: **Cover for suction nozzle**

(51) International Design Classification: **15-05**

(74) Name(s) of Attorney(s): **Callinans**

(71) Name(s) and Address(s) of Applicant(s):

**Wessel-Werk GmbH**

**Im Bruch 2 Reichshof-Wildbergerhutte 51580 Germany**

(72) Name(s) of Designer(s): **Martin Zydek**

(45) Registration Date: **06 May 2014**

(30) Convention priority data:

(31) Number

(32) Date

(33) Country

**002351007-0008 25 Nov 2013**

**OFFICE FOR HARMONISATION IN  
THE INTERNAL MARKET (OHIM)**

(56) Related Art Documents: **Not Applicable**

(57) Statement of Newness and Distinctiveness: **Newness and distinctiveness resides in the Application of the features of pattern and ornamentation to a cover for a suction nozzle as shown in the accompanying representations. Features shown in phantom lines do not constitute part of the design.**



(21) Design Number: **11787/2014**  
(22) Date of Filing Application: **10 April 2014**  
(24) Date from which industrial property rights may have effect: **10 April 2014**  
(54) Product in respect of which the design is registered: **Capacitive sensor flexible circuit**  
(51) International Design Classification: **13-02, 13-03NES**  
(74) Name(s) of Attorney(s): **Madderns**  
(71) Name(s) and Address(s) of Applicant(s):  
**Sentek Pty Ltd**  
**77 Magill Rd Stepney SA 5069 Australia**  
(72) Name(s) of Designer(s): **Michael Portmann**  
(45) Registration Date: **06 May 2014**  
(56) Related Art Documents: **Not Applicable**  
(57) Statement of Newness and Distinctiveness: **Nil**

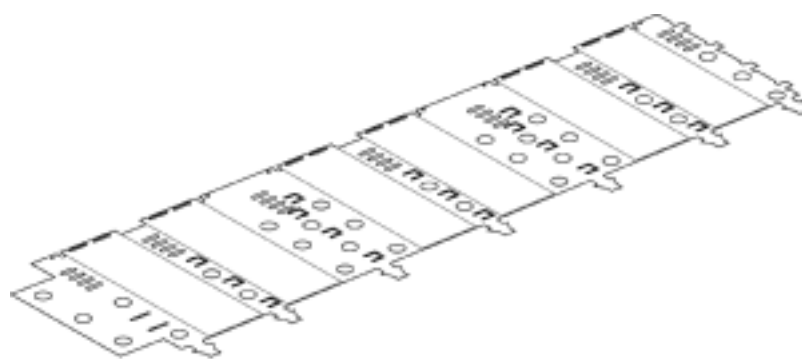

(21) Design Number: **11788/2014**  
(22) Date of Filing Application: **10 April 2014**  
(24) Date from which industrial property rights may have effect: **10 April 2014**  
(54) Product in respect of which the design is registered: **Suction nozzle**  
(51) International Design Classification: **15-05**  
(74) Name(s) of Attorney(s): **Callinans**  
(71) Name(s) and Address(s) of Applicant(s):  
**Wessel-Werk GmbH**  
**Im Bruch 2 Reichshof-Wildbergerhutte 51580 Germany**  
(72) Name(s) of Designer(s): **Martin Zydek**  
(45) Registration Date: **06 May 2014**  
(30) Convention priority data:  
(31) Number (32) Date (33) Country  
**002351007-0009 25 Nov 2013 OFFICE FOR HARMONISATION IN THE INTERNAL MARKET (OHIM)**  
(56) Related Art Documents: **Not Applicable**  
(57) Statement of Newness and Distinctiveness: **Newness and distinctiveness resides in the Application of the features of pattern and ornamentation to a suction nozzle as shown in the accompanying representation.**



- (21) Design Number: **11790/2014**  
(22) Date of Filing Application: **10 April 2014**  
(24) Date from which industrial property rights may have effect: **10 April 2014**  
(54) Product in respect of which the design is registered: **Multi-purpose shelving and rack unit**  
(51) International Design Classification: **06-04NES**  
(74) Name(s) of Attorney(s):  
(71) Name(s) and Address(s) of Applicant(s):  
**Ling Tu Lee**  
**15 Patrick St Box Hill North VIC 3129 Australia**  
(72) Name(s) of Designer(s): **Ling Tu Lee**  
(45) Registration Date: **06 May 2014**  
(56) Related Art Documents: **Not Applicable**  
(57) Statement of Newness and Distinctiveness: **Unit consists of individual pieces. Each piece has unique extrusion profiles which enable every piece to attach to one another or, detach from one another, via a push sliding fit mechanism. The attachment is held together by the dovetail male end and dovetail female groove, profiles of which runs along the length of the extrusion. The pieces (components) can be used to construct cabinet or rack with no constraints on shapes or number of shelves. Due to multiple dovetail grooves on each piece, some pieces can be omitted from the cabinet to double the size of the**

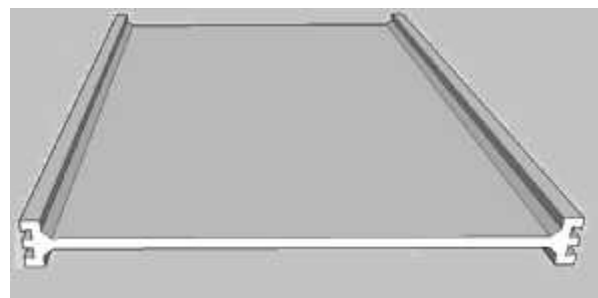

- (21) Design Number: **11791/2014**  
(22) Date of Filing Application: **10 April 2014**  
(24) Date from which industrial property rights may have effect: **10 April 2014**  
(54) Product in respect of which the design is registered: **Notification sign**  
(51) International Design Classification: **20-03C, 20-03NES**  
(74) Name(s) of Attorney(s): **Ascot Martin Registered Patent & Trade Mark Attorneys**  
(71) Name(s) and Address(s) of Applicant(s):  
**Nicole Anne Graham**  
**PO BOX 554 Wauchope NSW 2446 Australia**  
(72) Name(s) of Designer(s): **Nicole Anne Graham**  
(45) Registration Date: **06 May 2014**  
(56) Related Art Documents: **Not Applicable**  
(57) Statement of Newness and Distinctiveness: **The features of the design that are new and distinctive are the graphic elements, markings and lettering appearing on the face of a notification sign as shown in the accompanying representations without limitation as to the specific colours of such features, and without limitation as to the outer shape or three-dimensional shape of the sign.**



- (21) Design Number: **11792/2014**  
(22) Date of Filing Application: **11 April 2014**  
(24) Date from which industrial property rights may have effect: **11 April 2014**  
(54) Product in respect of which the design is registered: **Segmented plate**  
(51) International Design Classification: **07-01B**  
(74) Name(s) of Attorney(s): **Callinans**  
(71) Name(s) and Address(s) of Applicant(s):  
**The Decor Corporation Pty. Ltd.**  
**1314 Ferntree Gully Rd Scoresby VIC 3179 Australia**  
(72) Name(s) of Designer(s): **John Mosbech Nielsen and Michael Edward Philip Russel**  
(45) Registration Date: **06 May 2014**  
(56) Related Art Documents: **Not Applicable**  
(57) Statement of Newness and Distinctiveness: **Newness and originality resides in the application of the features of shape and configuration as applied to a Segmented Plate as shown in the accompanying representations.**

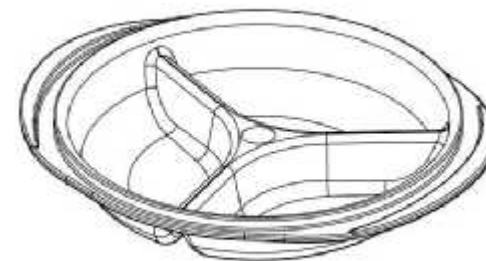

- (21) Design Number: **11793/2014**  
(22) Date of Filing Application: **11 April 2014**  
(24) Date from which industrial property rights may have effect: **11 April 2014**  
(54) Product in respect of which the design is registered: **Lighting device**  
(51) International Design Classification: **26-02**  
(74) Name(s) of Attorney(s): **Halfords IP**  
(71) Name(s) and Address(s) of Applicant(s):  
**Eveready Battery Company, Inc.**  
**533 Maryville University Drive St Louis Missouri 63141 United States of America**  
(72) Name(s) of Designer(s): **David J Hine and Donwoong Kang**  
(45) Registration Date: **06 May 2014**  
(30) Convention priority data:  
(31) Number      (32) Date      (33) Country  
**29/471767      05 Nov 2013      UNITED STATES OF AMERICA**  
(56) Related Art Documents: **Not Applicable**  
(57) Statement of Newness and Distinctiveness: **Newness and distinctiveness resides in those features of shape and or configuration of a lighting device as depicted in the representations. Features shown in broken lines do not form part of the design.**



- (21) Design Number: **11794/2014**  
(22) Date of Filing Application: **11 April 2014**  
(24) Date from which industrial property rights may have effect: **11 April 2014**  
(54) Product in respect of which the design is registered: **Paint spray gun**  
(51) International Design Classification: **08-05L**  
(74) Name(s) of Attorney(s): **WATERMARK PATENT AND TRADE MARKS ATTORNEYS**  
(71) Name(s) and Address(s) of Applicant(s):  
**Hsing-Tzu Wang**  
**No. 80 Ta-Hsin St Hsi Dist. Taichung City 40344 Taiwan, Province of China**  
(72) Name(s) of Designer(s): **Hsing-Tzu Wang**  
(45) Registration Date: **06 May 2014**  
(56) Related Art Documents: **Not Applicable**  
(57) Statement of Newness and Distinctiveness: **Nil**



- (21) Design Number: **11796/2014**  
(22) Date of Filing Application: **11 April 2014**  
(24) Date from which industrial property rights may have effect: **11 April 2014**  
(54) Product in respect of which the design is registered: **Golf club hosel**  
(51) International Design Classification: **21-02C**  
(74) Name(s) of Attorney(s): **Davies Collison Cave**  
(71) Name(s) and Address(s) of Applicant(s):  
**Karsten Manufacturing Corporation**  
**2201 West Desert Cove Phoenix Arizona 85029 United States of America**  
(72) Name(s) of Designer(s): **Ryan M Stokke and Martin R Jertson**  
(45) Registration Date: **06 May 2014**  
(30) Convention priority data:  
(31) Number (32) Date (33) Country  
**29/469758 14 Oct 2013 UNITED STATES OF AMERICA**  
(56) Related Art Documents: **Not Applicable**  
(57) Statement of Newness and Distinctiveness: **Newness and distinctiveness is claimed in the visual features shown in solid lines in the representations.**

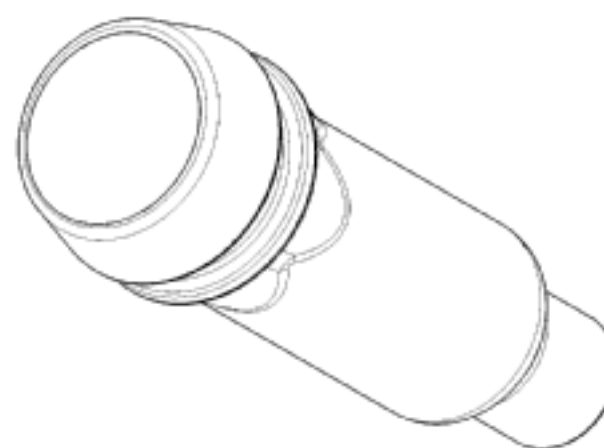

(21) Design Number: **11797/2014**  
(22) Date of Filing Application: **11 April 2014**  
(24) Date from which industrial property rights may have effect: **11 April 2014**  
(54) Product in respect of which the design is registered: **Packaging**  
(51) International Design Classification: **09-03A, 09-03M**  
(74) Name(s) of Attorney(s): **Shelston IP**  
(71) Name(s) and Address(s) of Applicant(s):  
**Nicoventures Holdings Limited**  
**4 Temple Place London WC2R 2PG United Kingdom**  
(72) Name(s) of Designer(s): **Matthew Nettenstrom and Tom McKeon and Justin Peart**  
(45) Registration Date: **06 May 2014**  
(30) Convention priority data:  
(31) Number (32) Date (33) Country  
**001387104 14 Oct 2013 OFFICE FOR HARMONISATION IN THE INTERNAL MARKET (OHIM)**  
(56) Related Art Documents: **Not Applicable**  
(57) Statement of Newness and Distinctiveness: **Newness and distinctiveness resides in the features of shape and configuration of a packaging as illustrated in solid lines in the accompanying representations. The features shown in broken lines are exemplary only and do not form part of the design.**

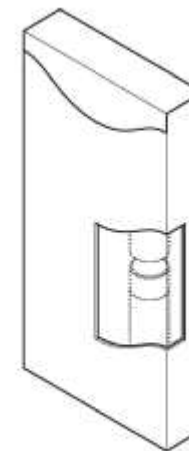

(21) Design Number: **11798/2014**  
(22) Date of Filing Application: **11 April 2014**  
(24) Date from which industrial property rights may have effect: **11 April 2014**  
(54) Product in respect of which the design is registered: **Packaging**  
(51) International Design Classification: **09-03A, 09-03M**  
(74) Name(s) of Attorney(s): **Shelston IP**  
(71) Name(s) and Address(s) of Applicant(s):  
**Nicoventures Holdings Limited**  
**4 Temple Place London WC2R 2PG United Kingdom**  
(72) Name(s) of Designer(s): **Matthew Nettenstrom and Tom McKeon and Justin Peart**  
(45) Registration Date: **06 May 2014**  
(30) Convention priority data:  
(31) Number (32) Date (33) Country  
**001387104 14 Oct 2013 OFFICE FOR HARMONISATION IN THE INTERNAL MARKET (OHIM)**  
(56) Related Art Documents: **Not Applicable**  
(57) Statement of Newness and Distinctiveness: **Newness and distinctiveness resides in the features of shape and configuration of a packaging as illustrated in the accompanying representations.**

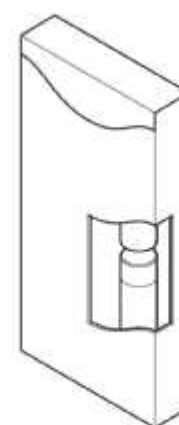

(21) Design Number: **11799/2014**

(22) Date of Filing Application: **11 April 2014**

(24) Date from which industrial property rights may have effect: **11 April 2014**

(54) Product in respect of which the design is registered: **Handle for grill brush**

(51) International Design Classification: **04-01**

(74) Name(s) of Attorney(s): **Callinans**

(71) Name(s) and Address(s) of Applicant(s):

**Betty Bossi AG**

**Burglistrasse 29 Zurich 8021 Switzerland**

(72) Name(s) of Designer(s): **Christoph Juan**

(45) Registration Date: **06 May 2014**

(30) Convention priority data:

(31) Number  
**773375301**

(32) Date  
**08 Nov 2013**

(33) Country  
**OFFICE FOR HARMONISATION IN  
THE INTERNAL MARKET (OHIM)**

(56) Related Art Documents: **Not Applicable**

(57) Statement of Newness and Distinctiveness: **Newness and originality resides in the features of shape and configuration as applied to a Handle for Grill Brush as shown in the accompanying representations**



(21) Design Number: **11801/2014**

(22) Date of Filing Application: **11 April 2014**

(24) Date from which industrial property rights may have effect: **11 April 2014**

(54) Product in respect of which the design is registered: **Head for grill brush**

(51) International Design Classification: **04-01**

(74) Name(s) of Attorney(s): **Callinans**

(71) Name(s) and Address(s) of Applicant(s):

**Betty Bossi AG**

**Burglistrasse 29 Zurich 8021 Switzerland**

(72) Name(s) of Designer(s): **Christoph Juan**

(45) Registration Date: **06 May 2014**

(30) Convention priority data:

(31) Number  
**773375301**

(32) Date  
**08 Nov 2013**

(33) Country  
**OFFICE FOR HARMONISATION IN  
THE INTERNAL MARKET (OHIM)**

(56) Related Art Documents: **Not Applicable**

(57) Statement of Newness and Distinctiveness: **Newness and originality resides in the features of shape and configuration as applied to a Head for Grill Brush**

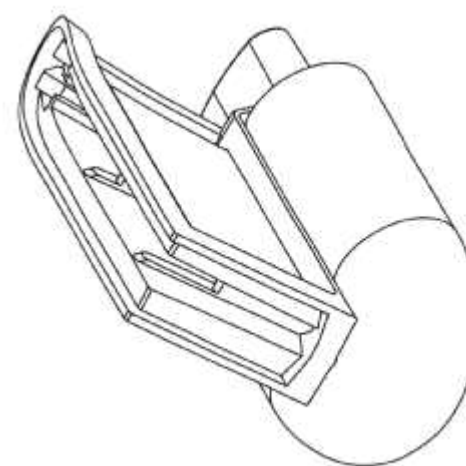

- (21) Design Number: **11802/2014**  
(22) Date of Filing Application: **11 April 2014**  
(24) Date from which industrial property rights may have effect: **11 April 2014**  
(54) Product in respect of which the design is registered: **A tyre**  
(51) International Design Classification: **12-15C**  
(74) Name(s) of Attorney(s): **WATERMARK PATENT AND TRADE MARKS ATTORNEYS**  
(71) Name(s) and Address(s) of Applicant(s):  
**Compagnie Generale Des Establisements Michelin**  
**12 cours Sablon Clermont-Ferrand 63000 France**  
**Michelin Recherche et Technique S.A.**  
**Route Louis Braille 10 Granges-Paccot 1763 Switzerland**  
(72) Name(s) of Designer(s): **Stephane Oraison and Eddy Baranger**  
(45) Registration Date: **06 May 2014**  
(30) Convention priority data:  
(31) Number (32) Date (33) Country  
**13/4592 22 Oct 2013 FRANCE**  
(56) Related Art Documents: **Not Applicable**  
(57) Statement of Newness and Distinctiveness: **Newness and distinctiveness resides in the appearance of the tread region of the tyre, the remainder of the tyre not forming part of the design.**

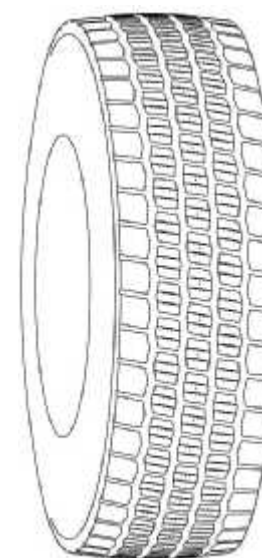

- (21) Design Number: **11803/2014**  
(22) Date of Filing Application: **11 April 2014**  
(24) Date from which industrial property rights may have effect: **11 April 2014**  
(54) Product in respect of which the design is registered: **A tyre**  
(51) International Design Classification: **12-15B**  
(74) Name(s) of Attorney(s): **WATERMARK PATENT AND TRADE MARKS ATTORNEYS**  
(71) Name(s) and Address(s) of Applicant(s):  
**Compagnie Generale Des Establisements Michelin**  
**12 cours Sablon Clermont-Ferrand 63000 France**  
**Michelin Recherche et Technique S.A.**  
**Route Louis Braille 10 Granges-Paccot 1763 Switzerland**  
(72) Name(s) of Designer(s): **Damien Bardin and Stephanie Cambon and Jonathan Lejeune and Frederic Honnorat**  
(45) Registration Date: **06 May 2014**  
(30) Convention priority data:  
(31) Number (32) Date (33) Country  
**13/4643 25 Oct 2013 FRANCE**  
(56) Related Art Documents: **Not Applicable**  
(57) Statement of Newness and Distinctiveness: **Newness and distinctiveness resides in the appearance of the tread region of the tyre shown in the drawings, the remainder of the tyre not forming part of the design.**

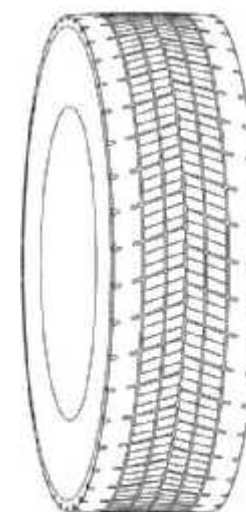

(21) Design Number: **11804/2014**  
(22) Date of Filing Application: **11 April 2014**  
(24) Date from which industrial property rights may have effect: **11 April 2014**  
(54) Product in respect of which the design is registered: **Domestic appliance**  
(51) International Design Classification: **31-00**  
(74) Name(s) of Attorney(s): **Freehills Patent Attorneys**  
(71) Name(s) and Address(s) of Applicant(s):

**SMEG S.p.A.**  
**Via Leonardo da Vinci, 4 Guastalla 42016 Italy**

(72) Name(s) of Designer(s): **Matteo Bazzicalupo and Raffaella Mangiarotti**

(45) Registration Date: **06 May 2014**

(30) Convention priority data:

(31) Number	(32) Date	(33) Country
<b>002324962</b>	<b>11 Oct 2013</b>	<b>OFFICE FOR HARMONISATION IN THE INTERNAL MARKET (OHIM)</b>



(56) Related Art Documents: **Not Applicable**

(57) Statement of Newness and Distinctiveness: **Newness and distinctiveness resides in the features of shape and configuration of the domestic appliance as shown in solid lines in the the representations, including those features shown in broken lines.**

(21) Design Number: **11805/2014**  
(22) Date of Filing Application: **11 April 2014**  
(24) Date from which industrial property rights may have effect: **11 April 2014**  
(54) Product in respect of which the design is registered: **Arithmetic and control unit**  
(51) International Design Classification: **14-02**  
(74) Name(s) of Attorney(s): **SPRUSON & FERGUSON**  
(71) Name(s) and Address(s) of Applicant(s):

**Fujitsu Limited**  
**1-1 Kamikodanaka 4-chome Nakahara-Ku Kawasaki-shi Kanagawa**  
**211-8588 Japan**

(72) Name(s) of Designer(s): **Yuki Zetsu and Hidebumi Yamaguchi and Nobuharu Tsusaka**

(45) Registration Date: **06 May 2014**

(30) Convention priority data:

(31) Number	(32) Date	(33) Country
<b>2013-024074</b>	<b>16 Oct 2013</b>	<b>JAPAN</b>



(56) Related Art Documents: **Not Applicable**

(57) Statement of Newness and Distinctiveness: **Newness and distinctiveness is claimed in the features of shape and/or configuration of an arithmetic and control unit as illustrated in the accompanying representations.**