



Australian Government

IP Australia

AUSTRALIAN OFFICIAL JOURNAL

OF

DESIGNS

Did you know a searchable version of this journal is now available online?

It's FREE and EASY to SEARCH.

Find it on our website (www.ipaustralia.gov.au)

by using the "Journals" link on the home page.

This Page Left Intentionally Blank

Contents

General Information & Notices

**Proceedings Under the Designs Act 1906 preserved as a result of the provisions of Chapter 12
Part 2 of the Designs Act 2003**

Names Registered - Alterations and Amendments	2646
Registrations Ceased	2646
Subsequent Owners Registered	2646

Proceedings Under the Designs Act 2003

Applications Lapsed	2663
Applications Lodged	2650
Applications Withdrawn	2663
Certificate of Examination	2667
Extension of Period of Registration of Design	2664
Extension of Time Granted Under Section 137	2665
Publication and Registration Proceedings	
Designs Registered 363784 to 364000.....	2668
Registrations Ceased	2664
Subsequent Owners Registered	2665
Corrigenda	2666

This Page Left Intentionally Blank

For information on the following please see our website www.ipaustralia.gov.au or contact our Customer Service Network on 1300651010

[Editorial enquiries](#)

[Contact information](#)

[Freedom of Information ACT](#)

[Professional Standards Board](#)

[Sales](#)

[Requests for Information under Section 194 \(c\)](#)

[Country Codes](#)

[Trade Mark and Designs Hearing Sessions](#)

[INID \(Internationally agreed Numbers for the Identification of Data\)](#)

“INID” NUMBERS in use on Australian Design Documents

“INID” is an acronym for “Internationally agreed Numbers for the Identification of Data”.

(10) Data concerning the registration/renewal

- (11) Serial number of the registration and/or number of the design document
- (12) Plain language designation of the kind of published document
- (19) Identification, using the two-letter code according to WIPO Standard ST.3, of the authority publishing or registering the industrial design

(20) Data concerning the application

- (21) Serial number of the application
- (22) Date of filing of the application
- (24) Date from which the industrial design right has effect

(30) Data relating to priority under the Paris Convention

- (31) Serial number assigned to the priority application
- (32) Date of filing of the priority application
- (33) Two-letter code, according to WIPO Standard ST.3, identifying the authority with which the priority application was made

(40) Date(s) of making information available to the public

- (45) Date of publication of the registered industrial design by printing or similar process, or making it available to the public by any other means

(50) Miscellaneous Information

- (51) International Classification for Industrial Designs (class and subclass of the Locarno Classification)
- (54) Designation of article(s) or product(s) covered by the industrial design or title of the industrial design
- (55) Reproduction of the industrial design (e.g., drawing, photograph) and explanations relating to the reproduction
- (56) List of prior art documents, if separate from descriptive text
- (57) Description of characteristic features of the industrial design including indication of colours

(60) References to other legally related application(s) and registration(s)

- (62) Serial number(s) and, if available, filing date(s) of application(s), registration(s) or document(s) related by division
- (66) Serial number(s) of the application, or the registration, of the design(s) which is (are) a variant(s) of the present one

(70) Identification of parties concerned with the application or registration

- (71) Name(s) and address(es) of the applicant(s)
- (72) Name(s) of the creator(s) if known to be such
- (74) Name(s) and address(es) of the representative(s)

This Page Left Intentionally Blank

Nil notices for this journal issue.

Proceedings under the Designs Act 1906 preserved as a result of the provisions of Chapter 12 Part 2 of the Designs Act 2003.

This Page Left Intentionally Blank

Applications Lapsed

There were no Applications Lapsed under this section

Registrations Ceased

Note: Some of the following Registrations may have been previously advertised as ceased. In this instance, the previous advertisement still prevails.

138590	138711	138712
139952	139954	139970
140171	140172	140293
140318	140338	140358
140375	140692	141083
141550	141782	142423
142500	142541	143124
143125	143126	143202
143545	144181	154902
155035	156158	156159
156160	156216	156217
156234	156235	156299
156336	156379	156455
156469	156470	156471
156548	156549	156586
156632	156827	156829
156843	156870	156942
156997	157041	157110
157491	157605	157743
157878	157966	158003
158033	158061	158285
158314	158348	158456

Subsequent Owners Registered

143290	(Kimberly-Clark Worldwide, Inc. a Wisconsin Corporation) Kimberly-Clark Worldwide Inc.
143207	(Kimberly-Clark Worldwide, Inc. a Wisconsin Corporation) Kimberly-Clark Worldwide Inc.
142479	(Kimberly-Clark Worldwide, Inc. a Wisconsin Corporation) Kimberly-Clark Worldwide Inc.
141399	(Kimberly-Clark Worldwide, Inc. a Wisconsin Corporation) Kimberly-Clark Worldwide Inc.
156435	(Edgewell Personal Care Brands, LLC) Playtex Products Inc.
157323	(Edgewell Personal Care Brands, LLC) Playtex Products Inc.
152833	(Edgewell Personal Care Brands, LLC) Playtex Products Inc.
153682	(Edgewell Personal Care Brands, LLC) Playtex Products Inc.

Names Registered - Alterations and Amendments

(The name in parentheses is the new name of the proprietor)

156192	(Tony Holmes) Tony Holmes
--------	------------------------------------

Subsequent Owners Registered

(The name in parentheses is that of the subsequent owner)

145825	(Kimberly-Clark Worldwide, Inc. a Wisconsin Corporation) Kimberly-Clark Worldwide Inc.
145988	(Kimberly-Clark Worldwide, Inc. a Wisconsin Corporation) Kimberly-Clark Worldwide Inc.
145681	(Kimberly-Clark Worldwide, Inc. a Wisconsin Corporation) Kimberly-Clark Worldwide Inc.
145680	(Kimberly-Clark Worldwide, Inc. a Wisconsin Corporation) Kimberly-Clark Worldwide Inc.
145679	(Kimberly-Clark Worldwide, Inc. a Wisconsin Corporation) Kimberly-Clark Worldwide Inc.
145678	(Kimberly-Clark Worldwide, Inc. a Wisconsin Corporation) Kimberly-Clark Worldwide Inc.
145490	(Kimberly-Clark Worldwide, Inc. a Wisconsin Corporation) Kimberly-Clark Worldwide Inc.
144869	(Kimberly-Clark Worldwide, Inc. a Wisconsin Corporation) Kimberly-Clark Worldwide Inc.
144516	(Kimberly-Clark Worldwide, Inc. a Wisconsin Corporation) Kimberly-Clark Worldwide Inc.
144308	(Kimberly-Clark Worldwide, Inc. a Wisconsin Corporation) Kimberly-Clark Worldwide Inc.
143581	(Kimberly-Clark Worldwide, Inc. a Wisconsin Corporation) Kimberly-Clark Worldwide Inc.
143291	(Kimberly-Clark Worldwide, Inc. a Wisconsin Corporation) Kimberly-Clark Worldwide Inc.

This Page Left Intentionally Blank

Proceedings under the Designs Act 2003.

This Page Left Intentionally Blank

Applications Lodged

Lodgement information is in the following order: **Applicant's Name**; International Classification, Name of Product, Lodgement Date and **Design Number**. If the applicant claims an earlier priority date under an International Convention, the Convention Country and the associated filing date are shown in parentheses before the Lodgement Date. Divisional information will also appear in parentheses before the Lodgement Date.

(we) dog, LLC; 30-99, Pet leash, (US, 04 Mar 2015) 31 Aug 2015	14576/2015	Adherium (NZ) Ltd (formerly Nexus6 Ltd); 24-01, A compliance monitor for a medicament inhaler, (EM, 03 Mar 2015) 03 Sep 2015	14673/2015
jeffacom; 07-02A, 900 mm wide standing oven, 07 Sep 2015	14721/2015	Adherium (NZ) Ltd (formerly Nexus6 Ltd); 24-01, A compliance monitor for a medicament inhaler, (EM, 03 Mar 2015) 02 Sep 2015	14649/2015
mPort Pty Ltd; 25-03, 16-99, Scanning booth, (US, 06 Mar 2015) 02 Sep 2015	14624/2015	Adherium (NZ) Ltd (formerly Nexus6 Ltd); 24-01, A compliance monitor for a medicament inhaler, (EM, 03 Mar 2015) 02 Sep 2015	14650/2015
A Plus Plastics & Tooling Pty Ltd; 21-01E, A cap, 26 Aug 2015	14459/2015	Align Technology, Inc.; 14-02, Cart-mounted display and computer for scanner, (US, 06 Mar 2015) 07 Sep 2015	14730/2015
A Plus Plastics & Tooling Pty Ltd; 09-03NES, A pod, 26 Aug 2015	14461/2015	Align Technology, Inc.; 14-02, Desktop display and computer for intraoral scanner, (US, 06 Mar 2015) 07 Sep 2015	14723/2015
A. Royale & Co (Aust) Pty Ltd; 13-03D, Adaptor, 25 Aug 2015	14415/2015	American Greetings Corporation; 06-09, Furry pillow, (US, 27 Aug 2015) 07 Sep 2015	14719/2015
A. Royale & Co (Aust) Pty Ltd; 13-03D, Adaptor, 25 Aug 2015	14414/2015	Amneal Pharmaceuticals Company GmbH; 24-04, Inhalation device, (US, 18 Mar 2015) 07 Sep 2015	14720/2015
A. Royale & Co (Aust) Pty Ltd; 13-03D, Adaptor, 25 Aug 2015	14410/2015	Anda, Carlos Arturo Espinosa Gallegos; 32-03, Cacao; quinoa; prawns; hats; translation, 04 Sep 2015	14704/2015
A. Royale & Co (Aust) Pty Ltd; 13-03D, Adaptor, 25 Aug 2015	14412/2015	Apple Inc.; 14-02, Display screen with graphical user interface, (US, 06 Mar 2015) 02 Sep 2015	14640/2015
A. Royale & Co (Aust) Pty Ltd; 13-03D, Adaptor, 25 Aug 2015	14411/2015	Apple Inc.; 14-02, A connector, (US, 06 Mar 2015) 03 Sep 2015	14683/2015
A. Royale & Co (Aust) Pty Ltd; 13-03D, Adaptor, 25 Aug 2015	14404/2015	Apple Inc.; 14-02, Connector, (US, 06 Mar 2015) 03 Sep 2015	14686/2015
A. Royale & Co (Aust) Pty Ltd; 13-03D, Adaptor, 25 Aug 2015	14402/2015	Apple Inc.; 14-02, Connector, (US, 06 Mar 2015) 03 Sep 2015	14684/2015
A. Royale & Co (Aust) Pty Ltd; 13-03D, Adaptor, 25 Aug 2015	14403/2015	Apple Inc.; 14-02, Display screen with graphical user interface, (US, 06 Mar 2015) 02 Sep 2015	14642/2015
Acmeda Pty Ltd; 08-05NES, 12-11, Chain tensioning device, 31 Aug 2015	14588/2015	Apple Inc.; 14-02, Display screen with graphical user interface, (US, 06 Mar 2015) 02 Sep 2015	14641/2015
Adherium (NZ) Ltd (formerly Nexus6 Ltd); 24-01, A compliance monitor for a medicament inhaler, (EM, 03 Mar 2015) 03 Sep 2015	14670/2015	Apple Inc.; 14-02, Display screen with graphical user interface, (US, 06 Mar 2015) 02 Sep 2015	14641/2015
Adherium (NZ) Ltd (formerly Nexus6 Ltd); 24-01, A compliance monitor for a medicament inhaler, (EM, 03 Mar 2015) 03 Sep 2015	14672/2015	Auldlist, Jack;The trustee for The Growndhogg Family Trust; 22-05, 08-03, Seeding equipment, 24 Aug 2015	14359/2015
Adherium (NZ) Ltd (formerly Nexus6 Ltd); 24-01, A compliance monitor for a medicament inhaler, (EM, 03 Mar 2015) 03 Sep 2015	14671/2015		
Adherium (NZ) Ltd (formerly Nexus6 Ltd); 24-01, A compliance monitor for a medicament inhaler, (EM, 03 Mar 2015) 03 Sep 2015	14668/2015		

Aurora Limited; 26-05E, LED downlights, (EM, 27 Feb 2015) 24 Aug 2015	14353/2015	Bloomberg Finance L.P.; 14-02, Dock for a keyboard, (US, 15 Dec 2014) (Divisional of 12995/2015) 24 Aug 2015	14338/2015
Aurora Limited; 26-05E, LED downlights, (EM, 14 Aug 2015) 24 Aug 2015	14354/2015	Bloomberg Finance L.P.; 14-02, Keypad, 01 Sep 2015	14615/2015
ASSA ABLOY Australia Pty Limited; 08-07, A key blank, 02 Sep 2015	14644/2015	Bloomberg Finance L.P.; 14-02, Keypad, 01 Sep 2015	14616/2015
AUSCOOL CONTRACTORS PTY LTD; 25-02B, A cold room door panel, 04 Sep 2015	14692/2015	Bloomberg Finance L.P.; 14-02, Keyboard and dock for a keyboard, (US, 15 Dec 2014) (Divisional of 12997/2015) 24 Aug 2015	14339/2015
AUSTRALIAN BALING SUPPLIES PTY LTD;Haasse, Willem Willem; 12-05, Load restraint cargo net for securing loads, 28 Aug 2015	14541/2015	Brand Developers Limited; 21-03, Balloon filling connector, 02 Sep 2015	14647/2015
AUSTRALIAN FASHION LABELS PTY LTD; 05-05NES, A textile print, 26 Aug 2015	14451/2015	Brand Developers Limited; 21-03, Balloon filling device, 02 Sep 2015	14645/2015
AUSTRALIAN FASHION LABELS PTY LTD; 05-05A, A textile print, 26 Aug 2015	14449/2015	Brand Developers Limited; 07-99B, Hot water bottle, 28 Aug 2015	14540/2015
Banko, Joshua David;Golnik, Timothy;Chang, Diana; 26-04, Light bulb, (US, 02 Jan 2015) (Divisional of 13287/2015) 24 Aug 2015	14327/2015	Brand Developers Limited; 07-99B, Hot water bottle, 28 Aug 2015	14539/2015
Banko, Joshua David;Golnik, Timothy;Chang, Diana; 26-04, Light bulb, (US, 02 Jan 2015) (Divisional of 13287/2015) 24 Aug 2015	14332/2015	Breville Pty Limited; 31-00, Base for personal blender, 25 Aug 2015	14419/2015
Banko, Joshua David;Golnik, Timothy;Chang, Diana; 26-04, Light bulb, (US, 02 Jan 2015) (Divisional of 13287/2015) 24 Aug 2015	14334/2015	Breville Pty Limited; 31-00, Lid and vessel for personal blender, 25 Aug 2015	14417/2015
Bend-tech Investments 1 Pty Ltd; 08-06, Handrail hinge, 24 Aug 2015	14320/2015	Busby, Shane Conrad; 06-04NES, Surfboard rack, 07 Sep 2015	14718/2015
Benoit, David B;Giancarlo, Phill A;Repp, Timothy C; 08-08NES, Activator device with lanyard, (US, 27 Feb 2015) 26 Aug 2015	14478/2015	Carol Cole Company; 28-03NES, Skin toning device, (US, 03 Mar 2015) 02 Sep 2015	14628/2015
Benoit, David B;Giancarlo, Phill A;Repp, Timothy C; 08-08NES, Activator device with clip, (US, 27 Feb 2015) 26 Aug 2015	14477/2015	Carter, Michael Anthony; 25-03, Transportable accommodation pod called Gunya Pod, 25 Aug 2015	14418/2015
Beyond Twenty Ltd; 27-06, Cartridge for an electronic cigarette case, 03 Sep 2015	14676/2015	Cha, Kyeong Ran;Cho, Hyoung Gi; 07-06NES, Drinking straw, (KR, 22 May 2015) 01 Sep 2015	14621/2015
Bigg, Stephen William; 11-02B, Products for growing vegetation, 02 Sep 2015	14648/2015	Chang, Diana;Golnik, Timothy;Banko, Joshua David; 26-04, Light bulb, (US, 02 Jan 2015) (Divisional of 13287/2015) 24 Aug 2015	14327/2015
Biomedical Industry Group Inc.; 24-01, Medical pump bracket, (CA, 23 Feb 2015) 24 Aug 2015	14324/2015	Chang, Diana;Golnik, Timothy;Blanko, Joshua David; 26-04, Light bulb, (US, 02 Jan 2015) (Divisional of 13287/2015) 24 Aug 2015	14335/2015
Blanko, Joshua David;Golnik, Timothy;Chang, Diana; 26-04, Light bulb, (US, 02 Jan 2015) (Divisional of 13287/2015) 24 Aug 2015	14335/2015	Chang, Diana;Golnik, Timothy;Banko, Joshua David; 26-04, Light bulb, (US, 02 Jan 2015) (Divisional of 13287/2015) 24 Aug 2015	14334/2015
		Chang, Diana;Golnik, Timothy;Banko, Joshua David; 26-04, Light bulb, (US, 02 Jan 2015) (Divisional of 13287/2015) 24 Aug 2015	14332/2015
		Cho, Hyoung Gi;Cha, Kyeong Ran; 07-06NES, Drinking straw, (KR, 22 May 2015) 01 Sep 2015	14621/2015

Colgate-Palmolive Company; 04-02, Oral care implement, (US, 25 Mar 2015) 31 Aug 2015	14549/2015	COMPAGNIE GENERALE DES ETABLISSEMENTS MICHELIN; Michelin Recherche et Technique S.A.; 12-15B, A tyre, (US, 29 Apr 2015) 03 Sep 2015	14688/2015
Colgate-Palmolive Company; 04-02, Oral care implement, (US, 25 Mar 2015) 31 Aug 2015	14548/2015	CONNECTED GROUP AUSTRALIA PTY LIMITED; 13-03D, Electrical power outlet and wall switches, 24 Aug 2015	14349/2015
Colgate-Palmolive Company; 04-02, Oral care implement, (US, 25 Mar 2015) 31 Aug 2015	14547/2015	CONNECTED GROUP AUSTRALIA PTY LIMITED; 13-03E, IP66 protected appliance inlet, 24 Aug 2015	14350/2015
Colgate-Palmolive Company; 04-02, Oral care implement, (US, 25 Mar 2015) 31 Aug 2015	14546/2015	Daikin Industries Ltd.; 23-04, Air conditioner, (JP, 09 Apr 2015) 31 Aug 2015	14585/2015
Conair Corporation; 11-01C, 28-03C, Convertible bracelet and hair retainer, (US, 10 Mar 2015) 31 Aug 2015	14578/2015	Daikin Industries Ltd.; 23-04, Air conditioner, (CN, 27 Mar 2015) 31 Aug 2015	14579/2015
Contemporary Design Group Pty Ltd; 06-01G, A chair, 27 Aug 2015	14493/2015	Daikin Industries Ltd.; 23-04, Air conditioner, (JP, 09 Apr 2015) 31 Aug 2015	14586/2015
Contemporary Design Group Pty Ltd; 06-03A, A table, 27 Aug 2015	14490/2015	Daikin Industries Ltd.; 23-04, Air conditioner, (JP, 09 Apr 2015) 31 Aug 2015	14584/2015
Contemporary Design Group Pty Ltd; 06-03B, A table, 27 Aug 2015	14497/2015	Dart Industries Inc.; 07-03, Sandwich spreader, (US, 03 Feb 2015) (Divisional of 13537/2015) 31 Aug 2015	14589/2015
Contemporary Design Group Pty Ltd; 06-01G, A lounge, 27 Aug 2015	14492/2015	Decked Out Trailers Pty Ltd; 12-10, Trailer, 03 Sep 2015	14667/2015
Contemporary Design Group Pty Ltd; 06-03A, A table, 27 Aug 2015	14498/2015	DAN FOAM ApS; 06-02, Bed assembly, (US, 03 Mar 2015) 02 Sep 2015	14626/2015
Contemporary Design Group Pty Ltd; 06-01G, A chair, 27 Aug 2015	14499/2015	DEOTECH KOREA CO., LTD.; 04-02, Toothbrush, (KR, 30 Jun 2015) 01 Sep 2015	14605/2015
Contemporary Design Group Pty Ltd; 06-01G, A lounge, 27 Aug 2015	14491/2015	DEOTECH KOREA CO., LTD.; 03-01D, Toothbrush holder, (KR, 30 Jun 2015) 01 Sep 2015	14607/2015
Contemporary Design Group Pty Ltd; 06-01G, A chair, 27 Aug 2015	14495/2015	Ethicon Endo-Surgery, Inc.; 24-01, End effector for ultrasonic surgical instrument, (US, 19 Mar 2015) 31 Aug 2015	14595/2015
Contemporary Design Group Pty Ltd; 06-01G, A chair, 27 Aug 2015	14494/2015	Euro-Pro Operating LLC; 31-00, Blender, (US, 21 May 2015) 31 Aug 2015	14560/2015
Cooper Tire & Rubber Company; 12-15D, Tire, (US, 27 Feb 2015) 27 Aug 2015	14513/2015	Euro-Pro Operating LLC; 31-00, Blender, (US, 06 Mar 2015) 31 Aug 2015	14557/2015
Cross, James Richard; 09-07A, Spout, 03 Sep 2015	14674/2015	Euro-Pro Operating LLC; 31-00, Blender, (US, 30 Jun 2015) 31 Aug 2015	14553/2015
Cullens Patent and Trade Mark Attorneys; 08-06, Fittings for doors, 17 Jun 2015	14625/2015	Euro-Pro Operating LLC; 31-00, Blender, (US, 30 Jun 2015) 31 Aug 2015	14559/2015
COLLUSION MUSIC AUSTRALIA LTD.; 26-05NES, Artistic design: project music scores to floor, 01 Sep 2015	14622/2015		
COMPAGNIE GENERALE DES ETABLISSEMENTS MICHELIN; Michelin Recherche et Technique S.A.; 12-15B, A tyre, (US, 29 Apr 2015) 03 Sep 2015	14690/2015		
COMPAGNIE GENERALE DES ETABLISSEMENTS MICHELIN; Michelin Recherche et Technique S.A.; 12-15B, A tyre, (US, 29 Apr 2015) 03 Sep 2015	14689/2015		

Euro-Pro Operating LLC; 31-00, Blender, (US, 21 May 2015) 31 Aug 2015	14555/2015	Forever New Clothing Pty Ltd; 02-02C, Article of clothing, 25 Aug 2015	14386/2015
Euro-Pro Operating LLC; 31-00, Blender, (US, 21 May 2015) 31 Aug 2015	14556/2015	Forever New Clothing Pty Ltd; 02-02C, Article of clothing, (Divisional of 16654/2014) 25 Aug 2015	14382/2015
Euro-Pro Operating LLC; 31-00, Blender, (US, 30 Jun 2015) 31 Aug 2015	14554/2015	Forever New Clothing Pty Ltd; 02-02C, Article of clothing, (Divisional of 16654/2014) 25 Aug 2015	14383/2015
Euro-Pro Operating LLC; 31-00, Blender, (US, 30 Jun 2015) 31 Aug 2015	14552/2015	Forever New Clothing Pty Ltd; 02-02C, Article of clothing, (Divisional of 16654/2014) 25 Aug 2015	14380/2015
Euro-Pro Operating LLC; 31-00, Blender, (US, 06 Mar 2015) 31 Aug 2015	14561/2015	Forever New Clothing Pty Ltd; 02-02C, Articles of clothing, (Divisional of 16654/2014) 25 Aug 2015	14384/2015
ETHICON, INC.; 24-02, Curved tissue fastening device, (Divisional of 12123/2015) 27 Aug 2015	14505/2015	Forever New Clothing Pty Ltd; 02-02C, Article of clothing, (Divisional of 16654/2014) 25 Aug 2015	14385/2015
ETHICON, INC.; 24-02, Curved tissue fastening device, (Divisional of 12123/2015) 27 Aug 2015	14506/2015	Forever New Clothing Pty Ltd; 02-02C, Article of clothing, (Divisional of 16654/2014) 25 Aug 2015	14381/2015
ETHICON, INC.; 24-02, Curved tissue fastening device, (Divisional of 12123/2015) 27 Aug 2015	14500/2015	Forever New Clothing Pty Ltd; 02-02C, Article of clothing, (Divisional of 16654/2014) 25 Aug 2015	14391/2015
ETHICON, INC.; 24-02, Curved tissue fastening device, (Divisional of 12123/2015) 27 Aug 2015	14496/2015	Forever New Clothing Pty Ltd; 02-02C, Article of clothing, (Divisional of 16654/2014) 25 Aug 2015	14377/2015
ETHICON, INC.; 24-02, Curved tissue fastening device, (Divisional of 12123/2015) 27 Aug 2015	14504/2015	Forever New Clothing Pty Ltd; 02-02C, Article of clothing, (Divisional of 16654/2014) 25 Aug 2015	14378/2015
ETHICON, INC.; 24-02, Curved tissue fastening device, (Divisional of 12123/2015) 27 Aug 2015	14489/2015	Forever New Clothing Pty Ltd; 02-02C, Article of clothing, (Divisional of 16654/2014) 25 Aug 2015	14398/2015
Fibishenko, Alex;New, Hillel; 32-03, Dento-facial rejuvenation treatment, 27 Aug 2015	14523/2015	Forever New Clothing Pty Ltd; 02-02C, Article of clothing., (Divisional of 16654/2014) 25 Aug 2015	14376/2015
Field, Lindsay William; 14-02, Financial product, for transacting a payment, 28 Aug 2015	14527/2015	Forever New Clothing Pty Ltd; 02-02C, Article of clothing, (Divisional of 16654/2014) 25 Aug 2015	14394/2015
Forever New Clothing Pty Ltd; 02-02C, Article of clothing, 28 Aug 2015	14528/2015	Forever New Clothing Pty Ltd; 02-02NES, Article of clothing, (Divisional of 16654/2014) 25 Aug 2015	14395/2015
Forever New Clothing Pty Ltd; 02-02C, Article of clothing, (Divisional of 16654/2014) 25 Aug 2015	14379/2015	Forever New Clothing Pty Ltd; 02-02C, Article of clothing, (Divisional of 16654/2014) 25 Aug 2015	14392/2015
Forever New Clothing Pty Ltd; 02-02C, Article of clothing, (Divisional of 16654/2014) 25 Aug 2015	14390/2015	Forever New Clothing Pty Ltd; 02-02NES, Article of clothing, (Divisional of 16654/2014) 25 Aug 2015	14396/2015
Forever New Clothing Pty Ltd; 02-02C, Article of clothing, (Divisional of 16654/2014) 25 Aug 2015	14389/2015	Forever New Clothing Pty Ltd; 02-02NES, Article of clothing, (Divisional of 16654/2014) 25 Aug 2015	14397/2015
Forever New Clothing Pty Ltd; 02-02C, Article of clothing, (Divisional of 16654/2014) 25 Aug 2015	14387/2015	Forever New Clothing Pty Ltd; 02-02C, Article of clothing, (Divisional of 16654/2014) 25 Aug 2015	14393/2015
Forever New Clothing Pty Ltd; 02-02C, Article of clothing, (Divisional of 16654/2014) 25 Aug 2015	14388/2015		

Gallagher Group Limited; 08-08K, Fence handle, (NZ, 10 Mar 2015) 03 Sep 2015	14653/2015	Guangzhou Gardenart Furniture Co., Ltd;Zhou, Xuan; 06-03A, Alu'table, 24 Aug 2015	14330/2015
Gerard Lighting Pty Ltd; 26-03, A flood light, 03 Sep 2015	14675/2015	Guangzhou Gardenart Furniture Co., Ltd;Zhou, Xuan; 06-01H, Alu' lounger, 24 Aug 2015	14328/2015
Giancarlo, Phill A;Benoit, David B;Repp, Timothy C; 08-08NES, Activator device with clip, (US, 27 Feb 2015) 26 Aug 2015	14477/2015	GE Healthcare Limited; 24-01, Radiosynthesis device, (GB, 12 Mar 2015) 04 Sep 2015	14694/2015
Giancarlo, Phill A;Benoit, David B;Repp, Timothy C; 08-08NES, Activator device with lanyard, (US, 27 Feb 2015) 26 Aug 2015	14478/2015	GROOM, IAN; 25-99, Stairs, 04 Sep 2015	14693/2015
Global Import Corporation Pty Ltd; 12-10, Camper trailer with canopy, 01 Sep 2015	14612/2015	GUANGZHOU GARDENART FURNITURE CO.LTD;Zhou, Xuan; 06-03A, Alu' ceramic table, 24 Aug 2015	14358/2015
Global Import Corporation Pty Ltd; 12-10, 12-16NES, Camper trailer - kitchen, 01 Sep 2015	14613/2015	GUANGZHOU GARDENART FURNITURE CO.LTD;Zhou, Xuan; 06-01F, Alu' armchair, 26 Aug 2015	14446/2015
Global Import Corporation Pty Ltd; 12-10, Camper trailer with canopy, 01 Sep 2015	14611/2015	GUANGZHOU GARDENART FURNITURE CO.LTD;Zhou, Xuan; 06-01H, Alu' Lounger, 26 Aug 2015	14447/2015
Golnik, Timothy;Chang, Diana;Banko, Joshua David; 26-04, Light bulb, (US, 02 Jan 2015) (Divisional of 13287/2015) 24 Aug 2015	14327/2015	GUANGZHOU GARDENART FURNITURE CO.LTD;Zhou, Xuan; 06-03A, Alu' Table, 24 Aug 2015	14357/2015
Golnik, Timothy;Chang, Diana;Blanko, Joshua David; 26-04, Light bulb, (US, 02 Jan 2015) (Divisional of 13287/2015) 24 Aug 2015	14335/2015	GUANGZHOU GARDENART FURNITURE CO.LTD;Zhou, Xuan; 06-01G, Alu' Sofa, 25 Aug 2015	14409/2015
Golnik, Timothy;Chang, Diana;Banko, Joshua David; 26-04, Light bulb, (US, 02 Jan 2015) (Divisional of 13287/2015) 24 Aug 2015	14332/2015	GUANGZHOU GARDENART FURNITURE CO.LTD;Zhou, Xuan; 06-01F, Alu' Armchair, 25 Aug 2015	14408/2015
Golnik, Timothy;Chang, Diana;Banko, Joshua David; 26-04, Light bulb, (US, 02 Jan 2015) (Divisional of 13287/2015) 24 Aug 2015	14334/2015	GUANGZHOU GARDENART FURNITURE CO.LTD;Zhou, Xuan; 06-01F, Alu' Armchair, 25 Aug 2015	14407/2015
Grant, Paal Benjamine; 07-02D, Fire pit, 03 Sep 2015	14678/2015	GUANGZHOU GARDENART FURNITURE CO.LTD;Zhou, Xuan; 06-01F, Alu' Armchair, 25 Aug 2015	14406/2015
Guangzhou Gardenart Furniture Co., Ltd;Zhou, Xuan; 06-03A, Alu'table, 24 Aug 2015	14329/2015	GUANGZHOU GARDENART FURNITURE CO.LTD;Zhou, Xuan; 06-01G, Alu' sofa, 24 Aug 2015	14355/2015
Guangzhou Gardenart Furniture Co., Ltd;Zhou, Xuan; 06-01F, Alu' dinning chair, 24 Aug 2015	14352/2015	GUANGZHOU GARDENART FURNITURE CO.LTD;Zhou, Xuan; 06-03A, Alu' table, 24 Aug 2015	14356/2015
Guangzhou Gardenart Furniture Co., Ltd;Zhou, Xuan; 06-01G, Alu' sofa, 24 Aug 2015	14333/2015	GUANGZHOU GARDENART FURNITURE CO., LTD;Zhou, Xuan; 06-01G, Alu' sofa, 25 Aug 2015	14424/2015
Guangzhou Gardenart Furniture Co., Ltd;Zhou, Xuan; 06-01F, Alu' sling armchair, 24 Aug 2015	14326/2015	GUANGZHOU GARDENART FURNITURE CO., LTD;Zhou, Xuan; 06-01G, Alu' sofa, 25 Aug 2015	14426/2015
Guangzhou Gardenart Furniture Co., Ltd;Zhou, Xuan; 06-01F, Alu' plastic chair, 24 Aug 2015	14348/2015	GUANGZHOU GARDENART FURNITURE CO., LTD;Zhou, Xuan; 06-01G, Alu' sofa, 25 Aug 2015	14425/2015
		Haasse, Willem Willem;AUSTRALIAN BALING SUPPLIES PTY LTD; 12-05, Load restraint cargo net for securing loads, 28 Aug 2015	14541/2015

Hagleitner, Hans Georg; 07-99C, Pin for a holder for rolls of paper, 31 Aug 2015	14600/2015	Honeywell International Inc.; 24-99, Peanut-shaped earplug with paddle handle, (US, 05 Mar 2015) 04 Sep 2015	14710/2015
Hagleitner, Hans Georg; 07-99C, Pin for a holder for rolls of paper, 31 Aug 2015	14599/2015	Hosking, Peter John; 15-03B, Brushcutter, 01 Sep 2015	14604/2015
Hagleitner, Hans Georg; 07-99C, Pin for a holder for rolls of paper, (EM, 31 Mar 2015) 31 Aug 2015	14598/2015	Hunter Douglas Inc.; 25-01NES, Sample deck for an architectural opening, (US, 09 Dec 2014) (Divisional of 12872/2015) 07 Sep 2015	14747/2015
Hagleitner, Hans Georg; 07-99C, Holder for rolls of paper, (EM, 31 Mar 2015) 31 Aug 2015	14582/2015	Hunter Douglas Inc.; 25-01NES, Sample deck for an architectural opening, (US, 09 Dec 2014) (Divisional of 12872/2015) 07 Sep 2015	14745/2015
Hagleitner, Hans Georg; 07-99C, Pin for a holder for rolls of paper, (EM, 31 Mar 2015) 31 Aug 2015	14597/2015	H2FLO PTY LTD; 23-01NES, Shuttle device, 28 Aug 2015	14532/2015
Hagleitner, Hans Georg; 07-99C, Pin for a holder for rolls of paper, (EM, 31 Mar 2015) 31 Aug 2015	14587/2015	I&P Co., Ltd.;Sumitomo Seika Chemicals Co., Ltd.;National Institute of Advanced Industrial Science and Technology; 13-99, Molded coil, (JP, 21 Jan 2015) 20 Jul 2015	14369/2015
Hagleitner, Hans Georg; 07-99C, Pin for a holder for rolls of paper, (EM, 31 Mar 2015) 31 Aug 2015	14594/2015	I&P Co., Ltd.;Sumitomo Seika Chemicals Co., Ltd.;National Institute of Advanced Industrial Science and Technology; 13-99, Molded coil, (JP, 08 Jun 2015) 20 Jul 2015	14368/2015
Hagleitner, Hans Georg; 07-99C, Holder for rolls of paper, (EM, 31 Mar 2015) 31 Aug 2015	14583/2015	I&P Co., Ltd.;Sumitomo Seika Chemicals Co., Ltd.;National Institute of Advanced Industrial Science and Technology; 13-99, Molded coil, (JP, 08 Jun 2015) 20 Jul 2015	14367/2015
Hagleitner, Hans Georg; 07-99C, Pin for a holder for rolls of paper, (EM, 31 Mar 2015) 31 Aug 2015	14593/2015	I&P Co., Ltd.;Sumitomo Seika Chemicals Co., Ltd.;National Institute of Advanced Industrial Science and Technology; 13-99, Molded coil, (JP, 08 Jun 2015) 20 Jul 2015	14365/2015
Hagleitner, Hans Georg; 07-99C, Pin for a holder for rolls of paper, (EM, 31 Mar 2015) 31 Aug 2015	14591/2015	I&P Co., Ltd.;Sumitomo Seika Chemicals Co., Ltd.;National Institute of Advanced Industrial Science and Technology; 13-99, Molded coil, (JP, 21 Jan 2015) 20 Jul 2015	14363/2015
Hanna, Julian; 08-03, A tile system for a seeding knife point, 26 Aug 2015	14480/2015	I&P Co., Ltd.;Sumitomo Seika Chemicals Co., Ltd.;National Institute of Advanced Industrial Science and Technology; 13-99, Molded coil, (JP, 21 Jan 2015) 20 Jul 2015	14366/2015
Hermes Sellier (Societe Par Actions Simplifiee); 03-01B, Bag, (WO, 05 Mar 2015) 24 Aug 2015	14331/2015	I&P Co., Ltd.;Sumitomo Seika Chemicals Co., Ltd.;National Institute of Advanced Industrial Science and Technology; 13-99, Molded coil, (JP, 21 Jan 2015) 20 Jul 2015	14364/2015
Hingston, Denis Tewheoro;Mason, Amy;Hingston, Louise; 07-05D, Transparent clothes dryer, 24 Aug 2015	14346/2015	I&P Co., Ltd.;Sumitomo Seika Chemicals Co., Ltd.;National Institute of Advanced Industrial Science and Technology; 13-99, Molded coil, (JP, 16 Apr 2015) 20 Jul 2015	14366/2015
Hingston, Louise;Hingston, Denis Tewheoro;Mason, Amy; 07-05D, Transparent clothes dryer, 24 Aug 2015	14346/2015	I&P Co., Ltd.;Sumitomo Seika Chemicals Co., Ltd.;National Institute of Advanced Industrial Science and Technology; 13-99, Molded coil, (JP, 21 Jan 2015) 20 Jul 2015	14364/2015
Hollister Incorporated; 24-02, Catheter gripper aid, (US, 10 Dec 2014) (Divisional of 12880/2015) 27 Aug 2015	14507/2015	Ideal Warehouse Innovations, Inc.; 15-99, Cartridge assembly, (CA, 03 Mar 2015) 03 Sep 2015	14677/2015
Hollywog, LLC; 24-01, Portable clinical cervical traction device, 24 Aug 2015	14347/2015	Ideal Warehouse Innovations, Inc.; 15-99, Cartridge, (CA, 03 Mar 2015) 03 Sep 2015	14680/2015
Honeywell International Inc.; 24-99, Pod-shaped earplug with paddle handle, (US, 05 Mar 2015) 04 Sep 2015	14709/2015		

Ideal Warehouse Innovations, Inc.; 12-02, Portable carrier, (CA, 03 Mar 2015) 03 Sep 2015	14685/2015	JOHNSON & JOHNSON MEDICAL GMBH; 24-03, Surgical mesh implant, (Divisional of 12761/2015) 07 Sep 2015	14724/2015
Ideal Warehouse Innovations, Inc.; 12-02, Portable carrier, (CA, 03 Mar 2015) 03 Sep 2015	14681/2015	JOHNSON & JOHNSON MEDICAL GMBH; 24-03, Surgical mesh implant, (Divisional of 12761/2015) 07 Sep 2015	14725/2015
Illinois Tool Works Inc.; 08-07, Escutcheon plate, 25 Aug 2015	14416/2015	JOHNSON & JOHNSON MEDICAL GMBH; 24-03, Surgical mesh implant, (Divisional of 12761/2015) 07 Sep 2015	14734/2015
International Refills Company Ltd.; 23-02NES, Diaper pail cassette, (CA, 25 Feb 2015) 25 Aug 2015	14399/2015	JOHNSON & JOHNSON MEDICAL GMBH; 24-03, Surgical mesh implant, 26 Aug 2015	14453/2015
Intertrading Australia Pty Ltd; 09-01NES, Bottle, 25 Aug 2015	14420/2015	JOHNSON & JOHNSON MEDICAL GMBH; 24-03, Surgical mesh implant, (Divisional of 12754/2015) 26 Aug 2015	14454/2015
Intex Group International Pty Ltd; 25-01NES, A flashing, 02 Sep 2015	14638/2015	Kane, Taylor; 32-03, Company logo, marketing material, website, 31 Aug 2015	14601/2015
Ivanova Holdings Pty Ltd; 01-01, Chocolate tablet, 02 Sep 2015	14631/2015	Kellogg Company; 09-03NES, Bowl bag with utensil, (US, 16 Mar 2015) 25 Aug 2015	14362/2015
Ivanova Holdings Pty Ltd; 01-01, Chocolate tablet, 02 Sep 2015	14637/2015	Kim Meller Imports Pty Ltd; 02-04NES, Shoe, 07 Sep 2015	14716/2015
Ivanova Holdings Pty Ltd; 01-01, Chocolate tablet, 02 Sep 2015	14635/2015	Koninklijke Philips N.V.; 14-02, Display screen with icon, (EM, 05 Mar 2015) 04 Sep 2015	14695/2015
Ivanova Holdings Pty Ltd; 01-01, Chocolate tablet, 02 Sep 2015	14632/2015	Koninklijke Philips N.V.; 26-05E, Led fixture, (EM, 28 Feb 2015) 26 Aug 2015	14429/2015
Ivanova Holdings Pty Ltd; 01-01, Chocolate tablet, 02 Sep 2015	14630/2015	Koninklijke Philips N.V.; 19-08, Sticker, (EM, 05 Mar 2015) 04 Sep 2015	14698/2015
Ivanova Holdings Pty Ltd; 01-01, Chocolate tablet, 02 Sep 2015	14633/2015	Koninklijke Philips N.V.; 26-05E, Led fixture, (EM, 28 Feb 2015) 26 Aug 2015	14427/2015
Ivanova Holdings Pty Ltd; 01-01, Chocolate tablet, 02 Sep 2015	14636/2015	Koninklijke Philips N.V.; 26-05E, LED fixture, (EM, 28 Feb 2015) 28 Aug 2015	14526/2015
Ivanova Holdings Pty Ltd; 01-01, Chocolate tablet, 02 Sep 2015	14634/2015	Koninklijke Philips N.V.; 26-05E, Led fixture, (EM, 28 Feb 2015) 26 Aug 2015	14428/2015
ISM OBJECTS PTY LTD; 26-05B, Floor lamp, (Divisional of 14100/2015) 01 Sep 2015	14609/2015	KAISHA, HOCHIKI KABUSHIKI; 10-05, Optical alarm, (JP, 02 Mar 2015) 01 Sep 2015	14617/2015
ISM OBJECTS PTY LTD; 26-05B, Table Lamp, (Divisional of 14100/2015) 01 Sep 2015	14610/2015	KENWOOD LIMITED; 13-03D, Control knob for a mixer, (EM, 25 Feb 2015) 25 Aug 2015	14360/2015
Johnson & Johnson Consumer Inc.; 24-04, Adhesive bandage with release liner, (US, 10 Mar 2015) 27 Aug 2015	14514/2015	KRAFT FOODS R&D, INC.; 09-03F, Confectionery packaging, (EM, 19 Mar 2015) 27 Aug 2015	14520/2015
Johnston, Gregory; 12-99, Sail track slider, 02 Sep 2015	14652/2015	KRAFT FOODS R&D, INC.; 09-03F, Confectionery packaging, (EM, 19 Mar 2015) 27 Aug 2015	14522/2015
Johnston, Gregory; 12-99, Sail batton receiver, 02 Sep 2015	14651/2015	KRAFT FOODS R&D, INC.; 09-03F, Confectionery packaging, (EM, 19 Mar 2015) 27 Aug 2015	14518/2015
JHRW Pty Ltd atf JHRW Family Trust; 08-08L, Support bracket, 01 Sep 2015	14614/2015		
JOHNSON & JOHNSON MEDICAL GMBH; 24-03, Surgical mesh implant, (Divisional of 12761/2015) 07 Sep 2015	14729/2015		
JOHNSON & JOHNSON MEDICAL GMBH; 24-03, Surgical mesh implant, (Divisional of 12761/2015) 07 Sep 2015	14726/2015		

KRAFT FOODS R&D, INC.; 09-03F, Confectionery packaging, (EM, 19 Mar 2015) 27 Aug 2015	14519/2015	LG Electronics Inc.; 15-05, Washing machine, (KR, 04 Mar 2015) 31 Aug 2015	14565/2015
KRAFT FOODS R&D, INC.; 09-03F, Confectionery packaging, (EM, 19 Mar 2015) 27 Aug 2015	14517/2015	LG Electronics Inc.; 15-05, Washing machine, (KR, 04 Mar 2015) 31 Aug 2015	14567/2015
KRAFT FOODS R&D, INC.; 09-03F, Confectionery packaging, (EM, 19 Mar 2015) 27 Aug 2015	14521/2015	LG Electronics Inc.; 15-05, Door for washing machine, (KR, 04 Mar 2015) 31 Aug 2015	14580/2015
Lavermicocca, Giovanni; 21-01M, Toy puzzle, 26 Aug 2015	14448/2015	LG Electronics Inc.; 15-05, Door for washing machine, (KR, 04 Mar 2015) 31 Aug 2015	14564/2015
Lesniowski, Alexander Andrew; 26-05B, Light stand, 06 Sep 2015	14715/2015	LG Electronics Inc.; 14-03B, TV receiver with graphical user interface, (KR, 25 Feb 2015) 25 Aug 2015	14375/2015
Lumen Labs, Inc.; 02-03, Bicycle helmet, (CN, 03 Mar 2015) 02 Sep 2015	14643/2015	LG Electronics Inc.; 14-03B, TV receiver with graphical user interface, (KR, 25 Feb 2015) 25 Aug 2015	14373/2015
Lumen Labs, Inc.; 02-03, Bicycle helmet, (CN, 03 Mar 2015) 02 Sep 2015	14639/2015	LG Electronics Inc.; 14-03B, TV receiver with graphical user interface, (KR, 25 Feb 2015) 25 Aug 2015	14370/2015
LBP Manufacturing LLC; 09-01B, Beverage container, (US, 27 Feb 2015) 26 Aug 2015	14441/2015	LG Electronics Inc.; 14-03B, TV receiver with graphical user interface, (KR, 25 Feb 2015) 25 Aug 2015	14371/2015
LG Electronics Inc.; 14-03B, TV receiver with graphical user interface, (KR, 25 Feb 2015) 25 Aug 2015	14372/2015	LG Electronics Inc.; 14-03B, TV receiver with graphical user interface, (KR, 25 Feb 2015) 25 Aug 2015	14401/2015
LG Electronics Inc.; 15-05, Washing machine, (KR, 04 Mar 2015) 31 Aug 2015	14575/2015	LG Electronics Inc.; 14-03B, TV receiver with graphical user interface, (KR, 25 Feb 2015) 25 Aug 2015	14400/2015
LG Electronics Inc.; 15-05, Washing machine, (KR, 04 Mar 2015) 31 Aug 2015	14577/2015	M.S. & D.A. Hand Enterprises Pty Ltd; 25-01K, Side guide extrusion for a roller shutter, 31 Aug 2015	14558/2015
LG Electronics Inc.; 15-05, Door for washing machine, (KR, 04 Mar 2015) 31 Aug 2015	14572/2015	M.S. & D.A. Hand Enterprises Pty Ltd; 25-01K, Mullion extrusion for a roller shutter, 31 Aug 2015	14551/2015
LG Electronics Inc.; 15-05, Washing machine, (KR, 04 Mar 2015) 31 Aug 2015	14574/2015	M.S. & D.A. Hand Enterprises Pty Ltd; 25-01K, End cap for a roller shutter slat, 31 Aug 2015	14550/2015
LG Electronics Inc.; 15-05, Washing machine, (KR, 04 Mar 2015) 31 Aug 2015	14573/2015	M.S. & D.A. Hand Enterprises Pty Ltd; 25-01K, Flanged side guide extrusion for a roller shutter, 31 Aug 2015	14562/2015
LG Electronics Inc.; 15-05, Door for washing machine, (KR, 04 Mar 2015) 31 Aug 2015	14571/2015	Mansley, Rick;Mansley, Derek Thomas; 24-01, Aged care and hospital bed industry, 02 Sep 2015	14654/2015
LG Electronics Inc.; 15-05, Washing machine, (KR, 04 Mar 2015) 31 Aug 2015	14570/2015	Mansley, Derek Thomas;Mansley, Rick; 24-01, Aged care and hospital bed industry, 02 Sep 2015	14654/2015
LG Electronics Inc.; 14-03B, TV receiver with graphical user interface, (KR, 25 Feb 2015) 25 Aug 2015	14374/2015	Mason, Amy;Hingston, Denis Tewheoro;Hingston, Louise; 07-05D, Transparent clothes dryer, 24 Aug 2015	14346/2015
LG Electronics Inc.; 15-05, Washing machine, (KR, 04 Mar 2015) 31 Aug 2015	14581/2015	McCredie, Donald; 02-02A, 02-02B, Body surf suit, 07 Sep 2015	14754/2015
LG Electronics Inc.; 15-05, Washing machine, (KR, 04 Mar 2015) 31 Aug 2015	14568/2015		

McIntosh, Jason; 12-16NES, Vehicle suspension component, (Divisional of 13182/2015) 03 Sep 2015	14669/2015	Montres Tudor SA; 10-02, Watch, (CH, 26 Feb 2015) 26 Aug 2015	14440/2015
Megabyte Limited; 14-03NES, RFID tag inlay, (HK, 05 Mar 2015) 05 Sep 2015	14711/2015	Montres Tudor SA; 10-02, Watch, (CH, 26 Feb 2015) 26 Aug 2015	14439/2015
Megabyte Limited; 14-03NES, RFID tag inlay, (HK, 05 Mar 2015) 05 Sep 2015	14712/2015	Multigate Medical Products Pty Ltd; 24-02, Electrosurgical Pen, 01 Sep 2015	14606/2015
Mehta, Ketan C; 24-04, Aspirator, (US, 10 Mar 2015) 07 Sep 2015	14741/2015	Multigate Medical Products Pty Ltd; 24-02, Electrosurgical Pen, 01 Sep 2015	14608/2015
Mehta, Ketan C; 24-04, Aspirator, (US, 10 Mar 2015) 07 Sep 2015	14742/2015	Nando's Limited; 09-01NES, Bottle, 27 Aug 2015	14508/2015
Melro Distributors Pty Ltd; 02-02NES, Ladies clothing, 31 Aug 2015	14629/2015	Nashco Holdings NSW Pty Ltd; 25-01C, Furring channel, 28 Aug 2015	14533/2015
Michelin Recherche et Technique S.A.;COMPAGNIE GENERALE DES ETABLISSEMENTS MICHELIN; 12-15B, A tyre, (US, 29 Apr 2015) 03 Sep 2015	14690/2015	Nashco Holdings NSW Pty Ltd; 25-01C, Furring channel, 28 Aug 2015	14534/2015
Michelin Recherche et Technique S.A.;COMPAGNIE GENERALE DES ETABLISSEMENTS MICHELIN; 12-15B, A tyre, (US, 29 Apr 2015) 03 Sep 2015	14689/2015	National Institute of Advanced Industrial Science and Technology;Sumitomo Seika Chemicals Co., Ltd.;I&P Co., Ltd.; 13-99, Molded coil, (JP, 16 Apr 2015) 20 Jul 2015	14366/2015
Michelin Recherche et Technique S.A.;COMPAGNIE GENERALE DES ETABLISSEMENTS MICHELIN; 12-15B, A tyre, (US, 29 Apr 2015) 03 Sep 2015	14687/2015	National Institute of Advanced Industrial Science and Technology;Sumitomo Seika Chemicals Co., Ltd.;I&P Co., Ltd.; 13-99, Molded coil, (JP, 21 Jan 2015) 20 Jul 2015	14369/2015
Michelin Recherche et Technique S.A.;COMPAGNIE GENERALE DES ETABLISSEMENTS MICHELIN; 12-15B, A tyre, (US, 29 Apr 2015) 03 Sep 2015	14688/2015	National Institute of Advanced Industrial Science and Technology;Sumitomo Seika Chemicals Co., Ltd.;I&P Co., Ltd.; 13-99, Molded coil, (JP, 08 Jun 2015) 20 Jul 2015	14368/2015
Microsoft Corporation; 14-03E, Handset, (US, 27 Feb 2015) 26 Aug 2015	14479/2015	National Institute of Advanced Industrial Science and Technology;Sumitomo Seika Chemicals Co., Ltd.;I&P Co., Ltd.; 13-99, Molded coil, (JP, 08 Jun 2015) 20 Jul 2015	14367/2015
Microsoft Corporation; 14-03E, Handset, (US, 27 Feb 2015) 26 Aug 2015	14476/2015	National Institute of Advanced Industrial Science and Technology;Sumitomo Seika Chemicals Co., Ltd.;I&P Co., Ltd.; 13-99, Molded coil, (JP, 21 Jan 2015) 20 Jul 2015	14365/2015
Microsoft Corporation; 14-03E, Handset, (US, 27 Feb 2015) 26 Aug 2015	14471/2015	National Institute of Advanced Industrial Science and Technology;Sumitomo Seika Chemicals Co., Ltd.;I&P Co., Ltd.; 13-99, Molded coil, (JP, 21 Jan 2015) 20 Jul 2015	14364/2015
Misfit Wearables Corporation; 10-04, Activity monitoring device, (US, 16 Dec 2014) (Divisional of 13044/2015) 24 Aug 2015	14340/2015	National Institute of Advanced Industrial Science and Technology;Sumitomo Seika Chemicals Co., Ltd.;I&P Co., Ltd.; 13-99, Molded coil, (JP, 21 Jan 2015) 20 Jul 2015	14363/2015
Misfit Wearables Corporation; 10-04, Activity monitoring device, (US, 16 Dec 2014) (Divisional of 13044/2015) 24 Aug 2015	14341/2015	New, Hillel;Fibishenko, Alex; 32-03, Dento-facial rejuvenation treatment, 27 Aug 2015	14523/2015
Montres Tudor SA; 10-07, Watch wristlet, (CH, 05 Mar 2015) 26 Aug 2015	14431/2015	Nguyen, Jonathan Duy Khac; 13-99, 08-08M, Solar panel with mounting bracket, 02 Sep 2015	14623/2015

Nicholson, Shane; 24-01, Incubator, 26 Aug 2015	14482/2015	Orion Holdings (Overseas) Limited; 06-02, Furniture, in particular bed frame, 07 Sep 2015	14749/2015
Nobel Biocare Services AG; 24-03, Dental implant abutment, (EM, 25 Feb 2015) 24 Aug 2015	14337/2015	Orion Holdings (Overseas) Limited; 06-01E, Modular chair, 07 Sep 2015	14748/2015
Nobel Biocare Services AG; 24-03, Dental implant abutment, (EM, 25 Feb 2015) 24 Aug 2015	14344/2015	Petmatrix LLC; 01-06, Edible pet chew, (US, 02 Mar 2015) 28 Aug 2015	14530/2015
Nobel Biocare Services AG; 24-03, Dental implant abutment, (EM, 25 Feb 2015) 24 Aug 2015	14345/2015	Petmatrix LLC; 01-06, Edible pet chew, (US, 02 Mar 2015) 28 Aug 2015	14531/2015
Nobel Biocare Services AG; 24-03, Dental implant abutment, (EM, 25 Feb 2015) 24 Aug 2015	14342/2015	Petmatrix LLC; 01-06, Edible pet chew, (US, 02 Mar 2015) 28 Aug 2015	14529/2015
Nobel Biocare Services AG; 24-03, Dental implant abutment, (EM, 25 Feb 2015) 24 Aug 2015	14343/2015	Point-n-Putt Pty. Ltd.; 21-02C, Golf club head, 27 Aug 2015	14515/2015
Nobel Biocare Services AG; 24-03, Dental implant abutment, (EM, 25 Feb 2015) 24 Aug 2015	14336/2015	PositiveG Investments Pty Ltd ATF The PositiveG Trust; 14-02, Display unit, 27 Aug 2015	14525/2015
Norris, Brian John; 21-01C, Victorian Railways narrow gauge 16mm scale models, 05 Sep 2015	14713/2015	PositiveG Investments Pty Ltd ATF The PositiveG Trust; 14-02, Display unit, 27 Aug 2015	14524/2015
Nuner, Louis;Usatti, Paolo; 30-02, Animal housing, 25 Aug 2015	14405/2015	Possibilities Management Group Pty Ltd; 20-03NES, Transparent self adhesive sign, 02 Sep 2015	14646/2015
Omega SA (Omega AG) (Omega Ltd.); 10-02, Watchcase, (WO, 10 Mar 2015) 04 Sep 2015	14700/2015	Prolitec Inc.; 24-02, Removable cartridge for a diffusion device, (US, 27 Feb 2015) 27 Aug 2015	14501/2015
Omega SA (Omega AG) (Omega Ltd.); 10-02, Watchcase, (WO, 10 Mar 2015) 04 Sep 2015	14696/2015	Property Trading Group Pty Limited; 25-02B, Upper frame, 25 Aug 2015	14423/2015
Omega SA (Omega AG) (Omega Ltd.); 10-07, Dial, (WO, 10 Mar 2015) 04 Sep 2015	14697/2015	Property Trading Group Pty Limited; 25-01C, Upper beam cross section, 25 Aug 2015	14421/2015
Omega SA (Omega AG) (Omega Ltd.); 10-07, Dial, (WO, 10 Mar 2015) 04 Sep 2015	14702/2015	Property Trading Group Pty Ltd; 25-02A, Support column, 25 Aug 2015	14422/2015
Omega SA (Omega AG) (Omega Ltd.); 10-02, Back of the case, (WO, 10 Mar 2015) 04 Sep 2015	14701/2015	PACCAR Inc.; 12-16C, Vehicle bumper, (US, 27 Feb 2015) 25 Aug 2015	14413/2015
Orion Holdings (Overseas) Limited; 06-02, Furniture, in particular bed frame, 07 Sep 2015	14753/2015	Rackley, Jenna; 02-01B, Dressing gown, 06 Sep 2015	14714/2015
Orion Holdings (Overseas) Limited; 06-02, Furniture, in particular bed frame, 07 Sep 2015	14755/2015	Reckitt Benckiser (Brands) Limited; 09-01NES, Bottles, (EM, 06 Mar 2015) 03 Sep 2015	14679/2015
Orion Holdings (Overseas) Limited; 06-02, Furniture, in particular bed frame, 07 Sep 2015	14751/2015	Reckitt Benckiser (Brands) Limited; 09-01NES, Bottle, (EM, 06 Mar 2015) 03 Sep 2015	14682/2015
Orion Holdings (Overseas) Limited; 06-02, Furniture, in particular bed frame, 07 Sep 2015	14752/2015	Repp, Timothy C;Benoit, David B;Giancarlo, Phill A; 08-08NES, Activator device with lanyard, (US, 27 Feb 2015) 26 Aug 2015	14478/2015
Orion Holdings (Overseas) Limited; 06-02, Furniture, in particular bed frame, 07 Sep 2015	14750/2015	Repp, Timothy C;Benoit, David B;Giancarlo, Phill A; 08-08NES, Activator device with clip, (US, 27 Feb 2015) 26 Aug 2015	14477/2015

Revol Porcelaine S.A.; 07-01B, Tableware, (EM, 06 Mar 2015) 04 Sep 2015	14699/2015	S.C. Johnson & Son, Inc.; 09-03L, 09-07A, Container with overcap, (EM, 05 Mar 2015) 27 Aug 2015	14509/2015
Revol Porcelaine S.A.; 07-01B, Tableware, (EM, 19 Mar 2015) 07 Sep 2015	14717/2015	S.C. Johnson & Son, Inc.; 09-07A, Overcap, (EM, 05 Mar 2015) 27 Aug 2015	14511/2015
Rogers, Kenneth Colin; 16-05, Collapsible tripod, 26 Aug 2015	14481/2015	Samsonite IP Holdings S.a r.l.; 03-01A, Luggage, (EM, 02 Mar 2015) 01 Sep 2015	14602/2015
Rolex SA; 10-07, Link member of watch bracelet, (CH, 26 Feb 2015) 26 Aug 2015	14444/2015	Samsonite IP Holdings S.a r.l.; 03-01A, Luggage, (EM, 02 Mar 2015) 01 Sep 2015	14603/2015
Rolex SA; 10-07, Watch bezel, (CH, 26 Feb 2015) 26 Aug 2015	14436/2015	Shen zhen value in action technology co., ltd; 13-02, A car charger, 26 Aug 2015	14450/2015
Rolex SA; 10-07, Watch mechanism, (CH, 03 Mar 2015) 26 Aug 2015	14437/2015	Shenzhen value in action technology; 13-02, A car charger, 26 Aug 2015	14452/2015
Rolex SA; 10-07, Watch dial, (CH, 26 Feb 2015) 26 Aug 2015	14434/2015	Shenzhen Sanpubense Technology Co., Ltd; 26-04, Led lamp, 27 Aug 2015	14510/2015
Rolex SA; 10-02, Watch and watch wristlet, (CH, 26 Feb 2015) 26 Aug 2015	14435/2015	Simplehuman, LLC; 09-09, Trash can, (US, 05 Mar 2015) 04 Sep 2015	14705/2015
Rolex SA; 10-07, Watch dial, (CH, 26 Feb 2015) 26 Aug 2015	14432/2015	Simplehuman, LLC; 06-07, Mirror assembly, (US, 06 Mar 2015) 04 Sep 2015	14703/2015
Rolex SA; 10-02, Watch, (CH, 26 Feb 2015) 26 Aug 2015	14438/2015	Simplehuman, LLC.; 23-02A, Soap pump, (US, 25 Feb 2015) 24 Aug 2015	14351/2015
Rolex SA; 10-07, Watch dial, (CH, 26 Feb 2015) 26 Aug 2015	14442/2015	Societe Bic; 28-03A, Shaving aid adaptor for razor head, (US, 26 Mar 2015) 07 Sep 2015	14739/2015
Rolex SA; 10-07, Watch dial, (CH, 26 Feb 2015) 26 Aug 2015	14443/2015	Societe Bic; 28-03A, Shaving aid adaptor for razor head, (US, 26 Mar 2015) 07 Sep 2015	14740/2015
Rolex SA; 10-07, Watch bezel, (CH, 26 Feb 2015) 26 Aug 2015	14433/2015	Spectrum Brands, Inc.; 07-02H, Grill, (US, 06 Mar 2015) 07 Sep 2015	14736/2015
Rotolight Limited; 26-05NES, Light for cinematography or photography, 28 Aug 2015	14538/2015	Spectrum Brands, Inc.; 07-02H, Griddle, (US, 05 Mar 2015) 07 Sep 2015	14728/2015
Rotolight Limited; 26-05NES, Light for cinematography or photography, 28 Aug 2015	14537/2015	Spectrum Brands, Inc.; 07-02H, Grill, (US, 06 Mar 2015) 07 Sep 2015	14738/2015
Runway Blue, LLC; 09-01NES, 07-01NES, Container and lid, (US, 11 Mar 2015) 27 Aug 2015	14516/2015	Spectrum Brands, Inc.; 07-02H, Griddle, (US, 05 Mar 2015) 07 Sep 2015	14727/2015
Rutledge, Jon; 08-10, Bicycle rack, 07 Sep 2015	14744/2015	Spectrum Brands, Inc.; 07-02H, Grill, (US, 06 Mar 2015) 07 Sep 2015	14737/2015
RF Surgical Systems, Inc.; 24-02, Hand-held antenna system, (US, 02 Mar 2015) 31 Aug 2015	14563/2015	Spectrum Brands, Inc.; 07-02H, Grill, (US, 06 Mar 2015) 07 Sep 2015	14735/2015
ROBERT BOSCH GMBH; 10-05, Motion detector, (US, 14 Apr 2015) 02 Sep 2015	14627/2015	Spectrum Brands, Inc.; 07-02H, Grill, (US, 06 Mar 2015) 07 Sep 2015	14743/2015

Spectrum Brands, Inc.; 07-02H, Grill with illuminable region, (US, 05 Mar 2015) 07 Sep 2015	14731/2015	Sunbeam Corporation Limited; 07-02F, Toaster, 24 Aug 2015	14322/2015
Spectrum Brands, Inc.; 07-02H, Grill, (US, 05 Mar 2015) 07 Sep 2015	14733/2015	Sunbeam Corporation Limited; 07-02K, Kettle, 24 Aug 2015	14323/2015
Spectrum Brands, Inc.; 07-02H, Grill, (US, 05 Mar 2015) 07 Sep 2015	14732/2015	Sunbeam Corporation Limited; 07-02F, Toaster, 24 Aug 2015	14321/2015
Straightcurve Pty Ltd; 25-01E, Garden edging, 01 Sep 2015	14620/2015	Swatch AG (Swatch SA) (Swatch Ltd.); 11-01C, Bracelet, (WO, 02 Mar 2015) 01 Sep 2015	14619/2015
Strydom, Nicolaas Johannes Hermanus; 08-07, A lock face plate, (ZA, 04 Mar 2015) 28 Aug 2015	14536/2015	SHIN MI (BRISBANE) PTY LTD; 09-03M, Beef leg bone extract-food packaging, 25 Aug 2015	14361/2015
Sumitomo Seika Chemicals Co., Ltd.; National Institute of Advanced Industrial Science and Technology;I&P Co., Ltd.; 13-99, Molded coil, (JP, 21 Jan 2015) 20 Jul 2015	14369/2015	Tali Corp.; 07-01C, Sleeve for small glass vessel, (US, 05 Mar 2015) 04 Sep 2015	14706/2015
Sumitomo Seika Chemicals Co., Ltd.; National Institute of Advanced Industrial Science and Technology;I&P Co., Ltd.; 13-99, Molded coil, (JP, 08 Jun 2015) 20 Jul 2015	14368/2015	The trustee for The Growndhogg Family Trust;Auldist, Jack; 22-05, 08-03, Seeding equipment, 24 Aug 2015	14359/2015
Sumitomo Seika Chemicals Co., Ltd.; National Institute of Advanced Industrial Science and Technology;I&P Co., Ltd.; 13-99, Molded coil, (JP, 16 Apr 2015) 20 Jul 2015	14366/2015	The Kanga Group Pty Limited; 07-02E, Smoker box; barbecue smoker; food smoker, 07 Sep 2015	14746/2015
Sumitomo Seika Chemicals Co., Ltd.; National Institute of Advanced Industrial Science and Technology;I&P Co., Ltd.; 13-99, Molded coil, (JP, 08 Jun 2015) 20 Jul 2015	14367/2015	The Trustee for Carbutt Family Trust; 02-02NES, Shirt, 28 Aug 2015	14535/2015
Sumitomo Seika Chemicals Co., Ltd.; National Institute of Advanced Industrial Science and Technology;I&P Co., Ltd.; 13-99, Molded coil, (JP, 21 Jan 2015) 20 Jul 2015	14365/2015	The Yokohama Rubber Co., Ltd.; 12-15A, Automobile tire, (JP, 27 Feb 2015) 27 Aug 2015	14486/2015
Sumitomo Seika Chemicals Co., Ltd.; National Institute of Advanced Industrial Science and Technology;I&P Co., Ltd.; 13-99, Molded coil, (JP, 21 Jan 2015) 20 Jul 2015	14364/2015	The Yokohama Rubber Co., Ltd.; 12-15A, Automobile tire, (JP, 27 Feb 2015) 27 Aug 2015	14484/2015
Sumitomo Seika Chemicals Co., Ltd.; National Institute of Advanced Industrial Science and Technology;I&P Co., Ltd.; 13-99, Molded coil, (JP, 21 Jan 2015) 20 Jul 2015	14363/2015	The Yokohama Rubber Co., Ltd.; 12-15B, Automobile tire, (JP, 27 Feb 2015) 27 Aug 2015	14485/2015
Sunbeam Corporation Limited; 08-99, Cable management device, 24 Aug 2015	14325/2015	Tom Dixon Limited; 26-05D, Lighting, (EM, 27 Feb 2015) 26 Aug 2015	14455/2015
		Tom Dixon Limited; 06-01G, Chair, (GB, 26 Feb 2015) 26 Aug 2015	14458/2015
		Tom Dixon Limited; 06-01E, Ottoman, (EM, 26 Feb 2015) 26 Aug 2015	14460/2015
		Tom Dixon Limited; 06-01G, Chair, (EM, 26 Feb 2015) 26 Aug 2015	14464/2015
		Tom Dixon Limited; 06-01G, Chair, (EM, 26 Feb 2015) 26 Aug 2015	14463/2015
		THE TRUSTEE FOR RICHMOND ENGINEERING UNIT TRUST; 12-02, Hand trolley, 07 Sep 2015	14722/2015
		THH - THE HANDBAG HANGER PTY LTD; 06-08, Handbag hanger, 31 Aug 2015	14566/2015

Uber Technologies, Inc.; 14-02, Computing device display screen, (US, 27 Feb 2015) 26 Aug 2015	14473/2015	Zhou, Xuan;GUANGZHOU GARDENART FURNITURE CO.LTD; 06-01F, Alu' Armchair, 25 Aug 2015	14408/2015
United Plastics (Australasia) Pty Ltd; 07-01NES, Container lid, 27 Aug 2015	14487/2015	Zhou, Xuan;GUANGZHOU GARDENART FURNITURE CO.LTD; 06-01F, Alu' Armchair, 25 Aug 2015	14407/2015
United Plastics (Australasia) Pty Ltd; 07-01NES, Container, 27 Aug 2015	14488/2015	Zhou, Xuan;GUANGZHOU GARDENART FURNITURE CO.LTD; 06-03A, Alu' ceramic table, 24 Aug 2015	14358/2015
Usatti, Paolo;Nuner, Louis; 30-02, Animal housing, 25 Aug 2015	14405/2015	Zhou, Xuan;Guangzhou Gardenart Furniture Co., Ltd; 06-01F, Alu' plastic chair, 24 Aug 2015	14348/2015
Vuly Property Pty Ltd; 21-02F, Trampoline cover, 01 Sep 2015	14618/2015	Zhou, Xuan;Guangzhou Gardenart Furniture Co., Ltd; 06-01F, Alu' sling armchair, 24 Aug 2015	14326/2015
VOLUMES LIGHT BOX COMPANY PTY LTD; 26-99, A light box with detachable header, 03 Sep 2015	14691/2015	Zhou, Xuan;Guangzhou Gardenart Furniture Co., Ltd; 06-01G, Alu' sofa, 24 Aug 2015	14333/2015
Wattcost Pty Ltd; 10-04, Electricity monitoring device, 31 Aug 2015	14592/2015	Zhou, Xuan;GUANGZHOU GARDENART FURNITURE CO.LTD; 06-01F, Alu' armchair, 26 Aug 2015	14446/2015
Wattcost Pty Ltd; 13-99, Sensor bracket, 31 Aug 2015	14596/2015	Zhou, Xuan;GUANGZHOU GARDENART FURNITURE CO.LTD; 06-01H, Alu' Lounger, 26 Aug 2015	14447/2015
Webster, Robert; 21-02D, Surfboard, 30 Aug 2015	14545/2015	Zhou, Xuan;Guangzhou Gardenart Furniture Co., Ltd; 06-03A, Alu'table, 24 Aug 2015	14355/2015
Whitworth Ute Trays Pty Ltd; 12-16NES, Ute tray barrier, 04 Sep 2015	14707/2015	Zhou, Xuan;GUANGZHOU GARDENART FURNITURE CO.LTD; 06-01G, Alu' sofa, 24 Aug 2015	14356/2015
Whitworth Ute Trays Pty Ltd; 12-16NES, Ute tray floor, 04 Sep 2015	14708/2015	Zhou, Xuan;GUANGZHOU GARDENART FURNITURE CO.LTD; 06-03A, Alu' table, 24 Aug 2015	14329/2015
Wm. Wrigley Jr. Company; 01-01, Confectionery piece, (US, 05 Mar 2015) 27 Aug 2015	14503/2015	Zhou, Xuan;Guangzhou Gardenart Furniture Co., Ltd; 06-01H, Alu' lounger, 24 Aug 2015	14328/2015
Wm. Wrigley Jr. Company; 01-01, Confectionery piece, (US, 05 Mar 2015) 27 Aug 2015	14502/2015	Zimmermann Wear Pty Limited; 02-02C, A dress, 03 Sep 2015	14655/2015
Zettabeam Pty Ltd; 14-03NES, A control device, 27 Aug 2015	14483/2015	Zimmermann Wear Pty Limited; 02-02C, A dress, 03 Sep 2015	14664/2015
Zhou, Xuan;GUANGZHOU GARDENART FURNITURE CO., LTD; 06-01G, Alu' sofa, 25 Aug 2015	14424/2015	Zimmermann Wear Pty Limited; 02-02C, A dress, 03 Sep 2015	14665/2015
Zhou, Xuan;GUANGZHOU GARDENART FURNITURE CO., LTD; 06-01G, Alu' sofa, 25 Aug 2015	14426/2015	Zimmermann Wear Pty Limited; 02-02C, A dress, 03 Sep 2015	14658/2015
Zhou, Xuan;GUANGZHOU GARDENART FURNITURE CO., LTD; 06-01G, Alu' sofa, 25 Aug 2015	14425/2015	Zimmermann Wear Pty Limited; 02-02C, A dress, 03 Sep 2015	14660/2015
Zhou, Xuan;GUANGZHOU GARDENART FURNITURE CO.LTD; 06-03A, Alu' Table, 24 Aug 2015	14357/2015	Zimmermann Wear Pty Limited; 02-02NES, A top, 03 Sep 2015	14661/2015
Zhou, Xuan;GUANGZHOU GARDENART FURNITURE CO.LTD; 06-01F, Alu' Armchair, 25 Aug 2015	14406/2015	Zimmermann Wear Pty Limited; 02-02C, A playsuit, 03 Sep 2015	14659/2015
Zhou, Xuan;Guangzhou Gardenart Furniture Co., Ltd; 06-01F, Alu' dinning chair, 24 Aug 2015	14352/2015		
Zhou, Xuan;GUANGZHOU GARDENART FURNITURE CO.LTD; 06-01G, Alu' Sofa, 25 Aug 2015	14409/2015		

Zimmermann Wear Pty Limited; 02-02C, A dress, 03 Sep 2015	14656/2015	3M Innovative Properties Company; 23-01G, Filter element, (US, 27 Feb 2015) 26 Aug 2015	14472/2015
Zimmermann Wear Pty Limited; 02-02NES, A bodice, 03 Sep 2015	14666/2015	3M Innovative Properties Company; 29-02, Respirator cartridge, (US, 27 Feb 2015) 26 Aug 2015	14457/2015
Zimmermann Wear Pty Limited; 02-02C, A playsuit, 03 Sep 2015	14662/2015	3M Innovative Properties Company; 23-01G, Filter element, (US, 27 Feb 2015) 26 Aug 2015	14474/2015
Zimmermann Wear Pty Limited; 02-02C, A dress, 03 Sep 2015	14663/2015	3M Innovative Properties Company; 29-02, Respirator mask, (US, 27 Feb 2015) 26 Aug 2015	14466/2015
Zimmermann Wear Pty Limited; 02-02C, A dress, 03 Sep 2015	14657/2015	3M Innovative Properties Company; 29-02, Respirator cartridge, (US, 27 Feb 2015) 26 Aug 2015	14456/2015
3M Innovative Properties Company; 23-01G, Filter element, (US, 27 Feb 2015) 26 Aug 2015	14475/2015	3M Innovative Properties Company; 29-02, Respirator mask, (US, 27 Feb 2015) 26 Aug 2015	14469/2015
3M Innovative Properties Company; 29-02, Respirator mask, (US, 27 Feb 2015) 26 Aug 2015	14470/2015	3M Innovative Properties Company; 29-02, Respirator mask, (US, 27 Feb 2015) 26 Aug 2015	14465/2015
3M Innovative Properties Company; 29-02, Respirator mask, (US, 27 Feb 2015) 26 Aug 2015	14467/2015	3M Innovative Properties Company; 29-02, Respirator mask, (US, 27 Feb 2015) 26 Aug 2015	14462/2015
3M Innovative Properties Company; 29-02, Respirator mask, (US, 27 Feb 2015) 26 Aug 2015	14468/2015		

Applications Withdrawn

14333 / 2015 (06-01G)

Applications Lapsed

10815 / 2015 (26-06)	12108 / 2015 (12-16K)
12113 / 2015 (09-03B)	12316 / 2015 (07-02E)
12352 / 2015 (21-01D)	12388 / 2015 (08-05NES)
12436 / 2015 (14-01)	12498 / 2015 (26-05D)
12500 / 2015 (14-99)	12635 / 2015 (32-03)
12702 / 2015 (12-16C)	

Extension of Period of Registration of Designs

331161	332724	332733
332775	332806	332807
332809	332813	332815
332840	332841	332842
332843	332844	332845
332847	332848	332881
332888	332910	332936
332954	332955	333022
333030	333044	333047
333078	333079	333087
333088	333089	333110
333111	333112	333113
333123	333124	333153
333154	333155	333156
333157	333159	333163
333165	333167	333168
333169	333170	333189
333198	333204	333218
333220	333230	333265
333266	333309	333313
333314	333315	333316
333318	333319	333320
333322	333325	333326
333327	333328	333329
333330	333331	333332
333344	333345	333346
333348	333349	333368
333369	333370	333371
333374	333380	333381
333448	333461	333462
333591	333592	333593
333594	333595	333611
333612	333613	333614
333662	333706	333707
333711	333712	333713
333719	333720	333732
333733	333734	333735
333782	333783	333792
333840	333841	333844
333860	333886	333887
333888	333889	333890
333891	333894	333895
333941	334502	334504
334505	334752	335262
335326	335327	335582
335583	336481	

304513	304514	304889
304912	304915	304916
304917	304918	304919
304920	304921	304922
304923	304924	304925
304948	304949	304950
304951	304952	304953
304954	305050	305080
305081	305082	305083
305084	305085	305086
305087	305132	305165
305261	305262	305263
305266	305267	305268
305269	305270	305278
305279	305281	305282
305284	305288	305399
305400	305404	305406
305459	305460	305461
305462	305463	305464
305465	305467	305523
305525	305528	305554
305555	305556	305558
305559	305564	305568
305569	305570	305571
305572	305592	305594
305839	305875	305876
305960	305961	305964
305965	306055	306099
306113	306138	306139
306140	306141	306142
306192	306235	306236
306245	306302	306303
306304	306430	306471
306979	307042	308010
329720	329721	329722
329723	329836	329837
329838	329839	329840
329866	329873	329875
329876	329878	329881
329884	329885	329886
329887	329888	329890
329891	329892	329893
329894	329895	329928
329953	329955	329956
329957	329964	329965
329978	329980	329981
329983	329984	329986
329987	329991	329993
330008	330022	330036
330038	330039	330040
330042	330088	330089
330101	330122	330123
330124	330148	330149
330263	330358	330519

Registrations Ceased

303799	304317	304318
--------	--------	--------

330560 330561 330630
 331346 331347 331394
 331429 331480 331481
 331482 332027 332204
 333106 333107 333108
 333109 333434 334686
 359488 359621 359901

Extensions of time granted under Section 137

Applications lodged under section 137 for extension of time have been granted.

- 10356/2015 **Oscar Valdes**
- 10521/2015 **Outlook Australia Pty Ltd**
- 11871/2015 **N2LOK Hardware Trading Pty Ltd**
- 11872/2015 **N2LOK Hardware Trading Pty Ltd**
- 363953 **ETHICON, INC.**
- 363813 **Koninklijke Philips N.V.**
- 363957 **Koninklijke Philips N.V.**

Subsequent Owners Registered

(The name in parentheses is that of the subsequent owner)

- 356950 (**Thermo Boutique Pty Ltd**) Physical Revolution Pty Ltd
- 325608 (**Kimberly-Clark Worldwide, Inc. a Wisconsin Corporation**) Kimberly-Clark Worldwide Inc.
- 331894 (**Kimberly-Clark Worldwide, Inc. a Wisconsin Corporation**) Kimberly-Clark Worldwide, Inc.
- 335427 (**Kimberly-Clark Worldwide, Inc. a Wisconsin Corporation**) Kimberly-Clark Worldwide, Inc.
- 340770 (**Kimberly-Clark Worldwide, Inc. a Wisconsin Corporation**) Kimberly-Clark Worldwide, Inc.
- 342671 (**Kimberly-Clark Worldwide, Inc. a Wisconsin Corporation**) Kimberly-Clark Worldwide, Inc.
- 341342 (**Kimberly-Clark Worldwide, Inc. a Wisconsin Corporation**) Kimberly-Clark Worldwide, Inc.
- 342670 (**Kimberly-Clark Worldwide, Inc. a Wisconsin Corporation**) Kimberly-Clark Worldwide, Inc.
- 350358 (**Kimberly-Clark Worldwide, Inc. a Wisconsin Corporation**) Kimberly-Clark Worldwide, Inc.
- 349705 (**Kimberly-Clark Worldwide, Inc. a Wisconsin Corporation**) Kimberly-Clark Worldwide, Inc.
- 350643 (**Kimberly-Clark Worldwide, Inc. a Wisconsin Corporation**) Kimberly-Clark Worldwide, Inc.
- 350356 (**Kimberly-Clark Worldwide, Inc. a Wisconsin Corporation**) Kimberly-Clark Worldwide, Inc.
- 349795 (**Kimberly-Clark Worldwide, Inc. a Wisconsin Corporation**) Kimberly-Clark Worldwide, Inc.
- 349796 (**Kimberly-Clark Worldwide, Inc. a Wisconsin Corporation**) Kimberly-Clark Worldwide, Inc.
- 351432 (**Kimberly-Clark Worldwide, Inc. a Wisconsin Corporation**) Kimberly-Clark Worldwide, Inc.
- 353362 (**Kimberly-Clark Worldwide, Inc. a Wisconsin Corporation**) Kimberly-Clark Worldwide, Inc.
- 352949 (**Kimberly-Clark Worldwide, Inc. a Wisconsin Corporation**) Kimberly-Clark Worldwide, Inc.

- 353385 (**Kimberly-Clark Worldwide, Inc. a Wisconsin Corporation**) Kimberly-Clark Worldwide, Inc.
- 356458 (**Kimberly-Clark Worldwide, Inc. a Wisconsin Corporation**) Kimberly-Clark Worldwide, Inc.
- 356017 (**Kimberly-Clark Worldwide, Inc. a Wisconsin Corporation**) Kimberly-Clark Worldwide, Inc.
- 356778 (**Kimberly-Clark Worldwide, Inc. a Wisconsin Corporation**) Kimberly-Clark Worldwide, Inc.
- 359186 (**Kimberly-Clark Worldwide, Inc. a Wisconsin Corporation**) Kimberly-Clark Worldwide, Inc.
- 360379 (**Kimberly-Clark Worldwide, Inc. a Wisconsin Corporation**) Kimberly-Clark Worldwide, Inc.
- 360943 (**Kimberly-Clark Worldwide, Inc. a Wisconsin Corporation**) Kimberly-Clark Worldwide, Inc.
- 360944 (**Kimberly-Clark Worldwide, Inc. a Wisconsin Corporation**) Kimberly-Clark Worldwide, Inc.
- 361211 (**Kimberly-Clark Worldwide, Inc. a Wisconsin Corporation**) Kimberly-Clark Worldwide, Inc.
- 361224 (**Kimberly-Clark Worldwide, Inc. a Wisconsin Corporation**) Kimberly-Clark Worldwide, Inc.
- 361368 (**Kimberly-Clark Worldwide, Inc. a Wisconsin Corporation**) Kimberly-Clark Worldwide, Inc.
- 325173 (**Kimberly-Clark Worldwide, Inc. a Wisconsin Corporation**) Kimberly-Clark Worldwide, Inc.
- 325176 (**Kimberly-Clark Worldwide, Inc. a Wisconsin Corporation**) Kimberly-Clark Worldwide, Inc.
- 326314 (**Kimberly-Clark Worldwide, Inc. a Wisconsin Corporation**) Kimberly-Clark Worldwide, Inc.
- 336084 (**Kimberly-Clark Worldwide, Inc. a Wisconsin Corporation**) Kimberly-Clark Worldwide, Inc.
- 336085 (**Kimberly-Clark Worldwide, Inc. a Wisconsin Corporation**) Kimberly-Clark Worldwide, Inc.
- 336086 (**Kimberly-Clark Worldwide, Inc. a Wisconsin Corporation**) Kimberly-Clark Worldwide, Inc.
- 341384 (**Kimberly-Clark Worldwide, Inc. a Wisconsin Corporation**) Kimberly-Clark Worldwide, Inc.
- 341385 (**Kimberly-Clark Worldwide, Inc. a Wisconsin Corporation**) Kimberly-Clark Worldwide, Inc.
- 341386 (**Kimberly-Clark Worldwide, Inc. a Wisconsin Corporation**) Kimberly-Clark Worldwide, Inc.
- 342052 (**Kimberly-Clark Worldwide, Inc. a Wisconsin Corporation**) Kimberly-Clark Worldwide, Inc.
- 342053 (**Kimberly-Clark Worldwide, Inc. a Wisconsin Corporation**) Kimberly-Clark Worldwide, Inc.
- 343027 (**Kimberly-Clark Worldwide, Inc. a Wisconsin Corporation**) Kimberly-Clark Worldwide, Inc.
- 343028 (**Kimberly-Clark Worldwide, Inc. a Wisconsin Corporation**) Kimberly-Clark Worldwide, Inc.
- 343148 (**Kimberly-Clark Worldwide, Inc. a Wisconsin Corporation**) Kimberly-Clark Worldwide, Inc.
- 343198 (**Kimberly-Clark Worldwide, Inc. a Wisconsin Corporation**) Kimberly-Clark Worldwide, Inc.
- 343199 (**Kimberly-Clark Worldwide, Inc. a Wisconsin Corporation**) Kimberly-Clark Worldwide, Inc.
- 343200 (**Kimberly-Clark Worldwide, Inc. a Wisconsin Corporation**) Kimberly-Clark Worldwide, Inc.
- 343273 (**Kimberly-Clark Worldwide, Inc. a Wisconsin Corporation**) Kimberly-Clark Worldwide, Inc.
- 343305 (**Kimberly-Clark Worldwide, Inc. a Wisconsin Corporation**) Kimberly-Clark Worldwide, Inc.
- 343306 (**Kimberly-Clark Worldwide, Inc. a Wisconsin Corporation**) Kimberly-Clark Worldwide, Inc.
- 343307 (**Kimberly-Clark Worldwide, Inc. a Wisconsin Corporation**) Kimberly-Clark Worldwide, Inc.
- 343308 (**Kimberly-Clark Worldwide, Inc. a Wisconsin Corporation**) Kimberly-Clark Worldwide, Inc.

343309 (**Kimberly-Clark Worldwide, Inc. a Wisconsin Corporation**) Kimberly-Clark Worldwide, Inc.
 345362 (**Kimberly-Clark Worldwide, Inc. a Wisconsin Corporation**) Kimberly-Clark Worldwide, Inc.
 345945 (**Kimberly-Clark Worldwide, Inc. a Wisconsin Corporation**) Kimberly-Clark Worldwide, Inc.
 345946 (**Kimberly-Clark Worldwide, Inc. a Wisconsin Corporation**) Kimberly-Clark Worldwide, Inc.
 348770 (**Kimberly-Clark Worldwide, Inc. a Wisconsin Corporation**) Kimberly-Clark Worldwide, Inc.
 348917 (**Kimberly-Clark Worldwide, Inc. a Wisconsin Corporation**) Kimberly-Clark Worldwide, Inc.
 352995 (**Kimberly-Clark Worldwide, Inc. a Wisconsin Corporation**) Kimberly-Clark Worldwide, Inc.
 350640 (**Kimberly-Clark Worldwide, Inc. a Wisconsin Corporation**) Kimberly-Clark Worldwide, Inc.
 350607 (**Kimberly-Clark Worldwide, Inc. a Wisconsin Corporation**) Kimberly-Clark Worldwide, Inc.
 350604 (**Kimberly-Clark Worldwide, Inc. a Wisconsin Corporation**) Kimberly-Clark Worldwide, Inc.
 335375 (**Kimberly-Clark Worldwide, Inc. a Wisconsin Corporation**) Kimberly-Clark Worldwide, Inc.
 335371 (**Kimberly-Clark Worldwide, Inc. a Wisconsin Corporation**) Kimberly-Clark Worldwide, Inc.
 325495 (**Kimberly-Clark Worldwide, Inc. a Wisconsin Corporation**) Kimberly-Clark Worldwide, Inc.
 362580 (**Kimberly-Clark Worldwide, Inc. a Wisconsin Corporation**) Kimberly-Clark Worldwide, Inc.
 362581 (**Kimberly-Clark Worldwide, Inc. a Wisconsin Corporation**) Kimberly-Clark Worldwide, Inc.
 362606 (**Kimberly-Clark Worldwide, Inc. a Wisconsin Corporation**) Kimberly-Clark Worldwide, Inc.
 363076 (**Kimberly-Clark Worldwide, Inc. a Wisconsin Corporation**) Kimberly-Clark Worldwide, Inc.
 324611 (**Edgewell Personal Care Brands, LLC**) Playtex Products, Inc.
 324612 (**Edgewell Personal Care Brands, LLC**) Playtex Products, Inc.
 324613 (**Edgewell Personal Care Brands, LLC**) Playtex Products, Inc.
 324662 (**Edgewell Personal Care Brands, LLC**) Playtex Products, Inc.
 324663 (**Edgewell Personal Care Brands, LLC**) Playtex Products, Inc.
 339261 (**Edgewell Personal Care Brands, LLC**) Playtex Products, LLC
 305786 (**Edgewell Personal Care Brands, LLC**) Playtex Products Inc.
 306000 (**Edgewell Personal Care Brands, LLC**) Playtex Products Inc.
 313104 (**Edgewell Personal Care Brands, LLC**) Playtex Products, Inc
 324564 (**Speciiflex Global, Inc. a Delaware corporation**) Jawaumi Pty Ltd
 330870 (**William Grant & Sons Limited**) The Drambuie Liqueur Company Limited
 330871 (**William Grant & Sons Limited**) The Drambuie Liqueur Company Limited
 330872 (**William Grant & Sons Limited**) The Drambuie Liqueur Company Limited
 330942 (**Gannell Developments Pty Ltd**) U-Bute International Pty Ltd
 330946 (**Gannell Developments Pty Ltd**) U-Bute International Pty Ltd
 331141 (**BLY IP INC**) Longyear TM, Inc.
 331142 (**BLY IP INC**) Longyear TM, Inc.

331143 (**BLY IP INC**) Longyear TM, Inc.
 338612 (**BLY IP INC**) Longyear TM, Inc.
 331987 (**Firetec (Europe) Limited**) Liangju Wu

Corrigenda

20511551 advertised on 16 July 2015 under the heading: Applications lapsed: Application Lapsed in Error.

Certificate(s) of Examination

363673
363682

06-03A
25-02B

07/09/2015
07/09/2015

Examination of the following Design Registration(s) has been completed. Infringement proceedings may now be commenced.

325331	23-04	25/08/2015
329974	09-03H	01/09/2015
329977	09-03H	01/09/2015
330016	07-01F	01/09/2015
334159	25-01D	01/09/2015
344439	23-04	25/08/2015
344441	23-04	25/08/2015
350615	06-04NES	26/08/2015
350985	14-01	02/09/2015
350988	14-01	02/09/2015
350989	14-01	02/09/2015
350990	14-01	02/09/2015
359005	14-02	31/08/2015
359748	14-01	07/09/2015
359934	14-01	07/09/2015
359935	14-01	07/09/2015
360083	28-03B	08/09/2015
361126	09-02NES	01/09/2015
361127	09-02NES	01/09/2015
361180	09-02NES	01/09/2015
361192	23-04	01/09/2015
361225	23-04	01/09/2015
361227	23-04	01/09/2015
361841	08-08NES	28/08/2015
362338	12-16K	03/09/2015
362522	07-02B	02/09/2015
362585	23-01D	26/08/2015
362619	02-04A	02/09/2015
362622	08-01	02/09/2015
362666	08-01	02/09/2015
362866	08-05A	08/09/2015
362912	11-01C	28/08/2015
362917	05-05NES	28/08/2015
362920	05-05A	25/08/2015
362921	05-05D	25/08/2015
362922	05-05NES	25/08/2015
362944	14-02	01/09/2015
363132	09-07A	27/08/2015
363154	03-01B	01/09/2015
363157	03-01B	25/08/2015
363158	03-01B	25/08/2015
363159	03-01B	25/08/2015
363168	28-03B	31/08/2015
363169	28-03B	31/08/2015
363170	28-03B	31/08/2015
363192	20-02NES	27/08/2015
363195	01-06	27/08/2015
363243	28-03B	31/08/2015
363248	12-11	28/08/2015
363261	07-01F	07/09/2015
363266	01-06	04/09/2015
363275	01-06	04/09/2015
363293	12-16B	26/08/2015
363361	25-03	01/09/2015
363373	24-99	01/09/2015
363585	09-05	03/09/2015
363597	09-05	03/09/2015
363629	09-05	03/09/2015
363672	06-03A	07/09/2015

Publication and Registration Proceedings

Designs Registered

This section provides a concordance between design number and registration number of Designs covered in this journal. It also shows the main class and registration date.

This section covers Registration numbers 363784 to 364000 .

The registration number shown below should be used in all future correspondence.

Design Number	Registration Number	International Classification Code (IDC)	Registration Date	Design Number	Registration Number	International Classification Code (IDC)	Registration Date
16154/2014	363943	09-01G	02/09/2015	13327/2015	363819	19-08	25/08/2015
16155/2014	363944	09-01G	02/09/2015	13328/2015	363958	14-02	07/09/2015
16156/2014	363945	09-01G	02/09/2015	13370/2015	363951	02-02C	02/09/2015
16654/2014	363889	02-02NES	28/08/2015	13373/2015	363948	02-02C	02/09/2015
11124/2015	363915	12-08	31/08/2015	13376/2015	363949	02-02C	02/09/2015
11125/2015	363916	12-16E	31/08/2015	13417/2015	363820	02-02B	25/08/2015
11126/2015	363917	12-16E	31/08/2015	13432/2015	363909	02-02B	31/08/2015
11127/2015	363918	12-16C	31/08/2015	13537/2015	363967	07-03	07/09/2015
11128/2015	363919	12-16E	31/08/2015	13540/2015	363902	15-09	31/08/2015
11129/2015	363920	12-16C	31/08/2015	13587/2015	363954	23-02C	03/09/2015
11130/2015	363972	12-16NES	07/09/2015	13588/2015	363955	23-02C	03/09/2015
11133/2015	363973	12-08	07/09/2015	13609/2015	363892	25-03	28/08/2015
11278/2015	363974	23-01A	07/09/2015	13611/2015	363893	08-07	28/08/2015
11365/2015	363793	31-00	25/08/2015	13642/2015	363847	07-05NES	26/08/2015
11546/2015	363794	08-06	25/08/2015	13643/2015	363848	07-05NES	26/08/2015
11547/2015	363795	08-06	25/08/2015	13783/2015	363996	02-06	08/09/2015
11551/2015	363950	02-04C	02/09/2015	13855/2015	363959	09-03M	07/09/2015
12075/2015	363873	08-05A	27/08/2015	13866/2015	363947	12-05	02/09/2015
12123/2015	363953	24-02	03/09/2015	13902/2015	363792	06-01C	25/08/2015
12597/2015	363846	09-07A	26/08/2015	13945/2015	363910	08-01	31/08/2015
12639/2015	363814	14-03NES	25/08/2015	13949/2015	363798	24-04	25/08/2015
12717/2015	363871	25-03	27/08/2015	13950/2015	363799	24-04	25/08/2015
12718/2015	363872	25-03	27/08/2015	13951/2015	363800	24-04	25/08/2015
12804/2015	363815	24-01	25/08/2015	13982/2015	363976	03-01NES	07/09/2015
12805/2015	363816	24-01	25/08/2015	13986/2015	363796	28-03NES	25/08/2015
12806/2015	363817	24-01	25/08/2015	13987/2015	363827	28-03NES	26/08/2015
12870/2015	363952	09-03NES	03/09/2015	13992/2015	363797	28-03NES	25/08/2015
12871/2015	363818	28-03B	25/08/2015	13995/2015	363801	28-03NES	25/08/2015
12880/2015	363946	24-04	02/09/2015	14070/2015	363802	09-01NES	25/08/2015
12968/2015	363821	19-08	25/08/2015	14071/2015	363803	07-01F	25/08/2015
12969/2015	363822	19-08	25/08/2015	14105/2015	363824	23-01A	25/08/2015
12970/2015	363940	21-02C	02/09/2015	14108/2015	363911	12-16NES	31/08/2015
12995/2015	363878	14-02	27/08/2015	14110/2015	363912	12-16NES	31/08/2015
12997/2015	363879	14-02	27/08/2015	14111/2015	363913	12-16NES	31/08/2015
13063/2015	363971	09-01NES	07/09/2015	14112/2015	363914	12-16NES	31/08/2015
13073/2015	363941	06-06G	02/09/2015	14116/2015	363804	12-16NES	25/08/2015
13074/2015	363823	14-02	25/08/2015	14117/2015	363805	26-05D	25/08/2015
13078/2015	363832	26-05B	26/08/2015	14118/2015	363806	09-04	25/08/2015
13085/2015	363890	21-02F	28/08/2015	14119/2015	363835	26-05NES	26/08/2015
13090/2015	363891	19-08	28/08/2015	14120/2015	363807	08-07	25/08/2015
13107/2015	363994	20-03NES	08/09/2015	14121/2015	363808	09-04	25/08/2015
13155/2015	363931	21-02NES	01/09/2015	14122/2015	363809	09-04	25/08/2015
13156/2015	363932	21-02NES	01/09/2015	14123/2015	363810	09-04	25/08/2015
13193/2015	363880	08-08M	27/08/2015	14124/2015	363836	12-15A	26/08/2015
13237/2015	363995	12-16B	08/09/2015	14127/2015	363811	06-09	25/08/2015
13270/2015	363975	09-01NES	07/09/2015	14128/2015	363812	09-01H	25/08/2015
13271/2015	363881	28-03C	27/08/2015	14129/2015	363834	09-01H	26/08/2015
13287/2015	363882	26-04	27/08/2015	14130/2015	363813	24-04	25/08/2015
13290/2015	363825	03-01NES	25/08/2015	14135/2015	363957	24-04	07/09/2015
13304/2015	363833	10-04	26/08/2015	14142/2015	363968	21-01A	07/09/2015

Publication and Registration Proceedings - Designs Registered cont'd

Design Number	Registration Number	International Classification Code (IDC)	Registration Date	Design Number	Registration Number	International Classification Code (IDC)	Registration Date
14143/2015	363969	21-01A	07/09/2015	14250/2015	363876	12-16C	27/08/2015
14144/2015	363970	21-01A	07/09/2015	14251/2015	363858	12-16B	26/08/2015
14146/2015	363903	08-05L	31/08/2015	14253/2015	363859	26-06	27/08/2015
14147/2015	363864	15-99	27/08/2015	14254/2015	363860	26-06	27/08/2015
14150/2015	363828	04-02	26/08/2015	14255/2015	363861	26-06	27/08/2015
14151/2015	363829	09-01H	26/08/2015	14256/2015	363865	25-01K	27/08/2015
14153/2015	363830	09-01K	26/08/2015	14257/2015	363866	25-01K	27/08/2015
14154/2015	363883	14-99	28/08/2015	14258/2015	363862	14-02	27/08/2015
14156/2015	363826	09-01NES	25/08/2015	14259/2015	363863	28-03NES	27/08/2015
14179/2015	363784	07-01C	25/08/2015	14260/2015	363877	12-12	27/08/2015
14181/2015	363785	24-02	25/08/2015	14261/2015	363907	12-12	31/08/2015
14182/2015	363786	24-02	25/08/2015	14263/2015	363867	07-02C	27/08/2015
14183/2015	363787	24-02	25/08/2015	14264/2015	363868	07-02NES	27/08/2015
14184/2015	363788	24-02	25/08/2015	14265/2015	363869	06-01NES	27/08/2015
14185/2015	363789	24-02	25/08/2015	14266/2015	363908	11-01C	31/08/2015
14186/2015	363790	24-02	25/08/2015	14267/2015	363942	10-02	02/09/2015
14187/2015	363791	24-02	25/08/2015	14269/2015	363870	25-01B	27/08/2015
14188/2015	363831	24-02	26/08/2015	14271/2015	363978	13-03D	07/09/2015
14189/2015	363837	24-02	26/08/2015	14272/2015	363979	13-03D	07/09/2015
14200/2015	363838	09-07C	26/08/2015	14277/2015	363921	12-16A	01/09/2015
14201/2015	363839	09-01NES	26/08/2015	14278/2015	363922	27-02	01/09/2015
14202/2015	363840	09-01NES	26/08/2015	14279/2015	363923	14-03A	01/09/2015
14203/2015	363841	09-01NES	26/08/2015	14281/2015	363956	09-05	03/09/2015
14204/2015	363842	12-16B	26/08/2015	14282/2015	363924	08-05L	01/09/2015
14205/2015	363849	12-16B	26/08/2015	14283/2015	363925	24-04	01/09/2015
14206/2015	363977	06-03C	07/09/2015	14284/2015	363926	12-02	01/09/2015
14207/2015	363843	07-01D	26/08/2015	14285/2015	363929	12-02	01/09/2015
14208/2015	363844	07-01D	26/08/2015	14286/2015	363927	21-02C	01/09/2015
14209/2015	363845	07-01D	26/08/2015	14287/2015	363928	21-02C	01/09/2015
14210/2015	363901	18-01	31/08/2015	14288/2015	363930	14-02	01/09/2015
14211/2015	363874	02-02C	27/08/2015	14289/2015	363934	14-02	02/09/2015
14212/2015	363875	18-01	27/08/2015	14291/2015	363935	08-08G	02/09/2015
14213/2015	363884	23-01H	28/08/2015	14292/2015	363936	02-06	02/09/2015
14214/2015	363885	08-07	28/08/2015	14293/2015	363937	02-06	02/09/2015
14221/2015	363886	21-01NES	28/08/2015	14294/2015	363938	02-06	02/09/2015
14222/2015	363898	09-01NES	28/08/2015	14295/2015	363939	26-05D	02/09/2015
14223/2015	363899	09-01NES	28/08/2015	14296/2015	363933	02-06	01/09/2015
14224/2015	363900	09-01NES	28/08/2015	14299/2015	363980	09-03M	07/09/2015
14227/2015	363887	31-00	28/08/2015	14300/2015	363981	14-01	07/09/2015
14229/2015	363904	29-02	31/08/2015	14301/2015	363982	09-07B	07/09/2015
14231/2015	363905	31-00	31/08/2015	14302/2015	363983	07-02R	07/09/2015
14232/2015	363888	08-08L	28/08/2015	14303/2015	363960	09-03M	07/09/2015
14233/2015	363894	31-00	28/08/2015	14304/2015	363961	21-02NES	07/09/2015
14234/2015	363896	23-02C	28/08/2015	14307/2015	363997	12-15C	08/09/2015
14235/2015	363895	26-01	28/08/2015	14310/2015	363962	15-03B	07/09/2015
14236/2015	363897	31-00	28/08/2015	14311/2015	363963	24-01	07/09/2015
14238/2015	363850	07-05A	26/08/2015	14315/2015	363964	07-04	07/09/2015
14239/2015	363851	08-08A	26/08/2015	14316/2015	363965	09-01K	07/09/2015
14241/2015	363852	31-00	26/08/2015	14318/2015	363966	11-02B	07/09/2015
14242/2015	363853	31-00	26/08/2015	14320/2015	363984	08-06	07/09/2015
14244/2015	363854	10-04	26/08/2015	14322/2015	363998	07-02F	08/09/2015
14245/2015	363906	31-00	31/08/2015	14340/2015	364000	10-04	08/09/2015
14247/2015	363855	15-02	26/08/2015	14341/2015	363999	10-04	08/09/2015
14248/2015	363856	08-08NES	26/08/2015	14342/2015	363989	24-03	08/09/2015
14249/2015	363857	12-16C	26/08/2015	14343/2015	363990	24-03	08/09/2015

Publication and Registration Proceedings - Designs Registered cont'd

Design Number	Registration Number	International Classification Code (IDC)	Registration Date	Design Number	Registration Number	International Classification Code (IDC)	Registration Date
14344/2015	363991	24-03	08/09/2015	14371/2015	363987	14-03B	08/09/2015
14345/2015	363992	24-03	08/09/2015	14375/2015	363988	14-03B	08/09/2015
14346/2015	363993	07-05D	08/09/2015				
14348/2015	363985	06-01F	08/09/2015				
14370/2015	363986	14-03B	08/09/2015				

Publication and Registration Proceedings

Class Listing of Designs Published or Registered

The following section shows an International Classification Code listing of the Registered or Published Designs covered in this supplement.

Classification	Registration Number	Design Number	Classification	Registration Number	Design Number
02-02B	363820	13417/2015	08-08L	363888	14232/2015
02-02B	363909	13432/2015	08-08M	363880	13193/2015
02-02C	363874	14211/2015	08-08NES	363850	14238/2015
02-02C	363948	13373/2015	08-08NES	363856	14248/2015
02-02C	363949	13376/2015	09-01G	363943	16154/2014
02-02C	363951	13370/2015	09-01G	363944	16155/2014
02-02NES	363889	16654/2014	09-01G	363945	16156/2014
02-04C	363950	11551/2015	09-01H	363812	14128/2015
02-06	363933	14296/2015	09-01H	363829	14151/2015
02-06	363936	14292/2015	09-01H	363834	14129/2015
02-06	363937	14293/2015	09-01K	363830	14153/2015
02-06	363938	14294/2015	09-01K	363965	14316/2015
02-06	363996	13783/2015	09-01NES	363802	14070/2015
03-01A	363806	14118/2015	09-01NES	363803	14071/2015
03-01NES	363825	13290/2015	09-01NES	363826	14156/2015
03-01NES	363976	13982/2015	09-01NES	363839	14201/2015
04-02	363828	14150/2015	09-01NES	363840	14202/2015
06-01C	363792	13902/2015	09-01NES	363841	14203/2015
06-01F	363985	14348/2015	09-01NES	363898	14222/2015
06-01NES	363869	14265/2015	09-01NES	363899	14223/2015
06-03C	363977	14206/2015	09-01NES	363900	14224/2015
06-06G	363869	14265/2015	09-01NES	363971	13063/2015
06-06G	363941	13073/2015	09-01NES	363975	13270/2015
06-09	363811	14127/2015	09-03M	363959	13855/2015
07-01C	363784	14179/2015	09-03M	363960	14303/2015
07-01D	363843	14207/2015	09-03M	363980	14299/2015
07-01D	363844	14208/2015	09-03NES	363952	12870/2015
07-01D	363845	14209/2015	09-04	363806	14118/2015
07-01F	363803	14071/2015	09-04	363808	14121/2015
07-02C	363867	14263/2015	09-04	363809	14122/2015
07-02F	363998	14322/2015	09-04	363810	14123/2015
07-02NES	363867	14263/2015	09-05	363956	14281/2015
07-02NES	363868	14264/2015	09-07A	363846	12597/2015
07-02R	363983	14302/2015	09-07B	363982	14301/2015
07-03	363967	13537/2015	09-07C	363838	14200/2015
07-04	363906	14245/2015	10-02	363908	14266/2015
07-04	363964	14315/2015	10-02	363942	14267/2015
07-05A	363850	14238/2015	10-04	363833	13304/2015
07-05D	363993	14346/2015	10-04	363854	14244/2015
07-05NES	363847	13642/2015	10-04	363888	14232/2015
07-05NES	363848	13643/2015	10-04	363999	14341/2015
08-01	363910	13945/2015	10-04	364000	14340/2015
08-05A	363873	12075/2015	11-01C	363908	14266/2015
08-05L	363903	14146/2015	11-02B	363966	14318/2015
08-05L	363924	14282/2015	12-02	363926	14284/2015
08-06	363794	11546/2015	12-02	363929	14285/2015
08-06	363795	11547/2015	12-05	363947	13866/2015
08-06	363984	14320/2015	12-08	363915	11124/2015
08-07	363807	14120/2015	12-08	363973	11133/2015
08-07	363885	14214/2015	12-12	363877	14260/2015
08-07	363893	13611/2015	12-12	363907	14261/2015
08-08A	363851	14239/2015	12-15A	363836	14124/2015
08-08G	363935	14291/2015	12-15C	363997	14307/2015

Registration Proceedings - Class Listing of Designs Published or Registered cont'd

Classification	Registration Number	Design Number	Classification	Registration Number	Design Number
12-16A	363921	14277/2015	21-02NES	363961	14304/2015
12-16B	363842	14204/2015	23-01A	363824	14105/2015
12-16B	363849	14205/2015	23-01A	363974	11278/2015
12-16B	363858	14251/2015	23-01H	363884	14213/2015
12-16B	363995	13237/2015	23-02C	363896	14234/2015
12-16C	363857	14249/2015	23-02C	363954	13587/2015
12-16C	363876	14250/2015	23-02C	363955	13588/2015
12-16C	363918	11127/2015	24-01	363815	12804/2015
12-16C	363920	11129/2015	24-01	363816	12805/2015
12-16E	363916	11125/2015	24-01	363817	12806/2015
12-16E	363917	11126/2015	24-01	363963	14311/2015
12-16E	363919	11128/2015	24-02	363785	14181/2015
12-16NES	363804	14116/2015	24-02	363786	14182/2015
12-16NES	363911	14108/2015	24-02	363787	14183/2015
12-16NES	363912	14110/2015	24-02	363788	14184/2015
12-16NES	363913	14111/2015	24-02	363789	14185/2015
12-16NES	363914	14112/2015	24-02	363790	14186/2015
12-16NES	363972	11130/2015	24-02	363791	14187/2015
13-03D	363978	14271/2015	24-02	363831	14188/2015
13-03D	363979	14272/2015	24-02	363837	14189/2015
14-01	363981	14300/2015	24-02	363953	12123/2015
14-02	363823	13074/2015	24-03	363989	14342/2015
14-02	363862	14258/2015	24-03	363990	14343/2015
14-02	363878	12995/2015	24-03	363991	14344/2015
14-02	363879	12997/2015	24-03	363992	14345/2015
14-02	363930	14288/2015	24-04	363798	13949/2015
14-02	363934	14289/2015	24-04	363799	13950/2015
14-02	363958	13328/2015	24-04	363800	13951/2015
14-03A	363923	14279/2015	24-04	363813	14130/2015
14-03B	363986	14370/2015	24-04	363925	14283/2015
14-03B	363987	14371/2015	24-04	363946	12880/2015
14-03B	363988	14375/2015	24-04	363957	14135/2015
14-03NES	363814	12639/2015	24-99	363886	14221/2015
14-99	363883	14154/2015	25-01B	363870	14269/2015
15-02	363855	14247/2015	25-01K	363865	14256/2015
15-03B	363962	14310/2015	25-01K	363866	14257/2015
15-09	363902	13540/2015	25-03	363871	12717/2015
15-99	363864	14147/2015	25-03	363872	12718/2015
18-01	363875	14212/2015	25-03	363892	13609/2015
18-01	363901	14210/2015	25-03	363893	13611/2015
19-08	363819	13327/2015	26-01	363895	14235/2015
19-08	363821	12968/2015	26-03	363835	14119/2015
19-08	363822	12969/2015	26-04	363882	13287/2015
19-08	363891	13090/2015	26-05B	363832	13078/2015
20-03C	363804	14116/2015	26-05D	363805	14117/2015
20-03NES	363994	13107/2015	26-05D	363939	14295/2015
21-01A	363968	14142/2015	26-05NES	363835	14119/2015
21-01A	363969	14143/2015	26-06	363859	14253/2015
21-01A	363970	14144/2015	26-06	363860	14254/2015
21-01NES	363886	14221/2015	26-06	363861	14255/2015
21-02C	363927	14286/2015	27-02	363922	14278/2015
21-02C	363928	14287/2015	28-03B	363818	12871/2015
21-02C	363940	12970/2015	28-03C	363881	13271/2015
21-02F	363890	13085/2015	28-03NES	363796	13986/2015
21-02NES	363931	13155/2015	28-03NES	363797	13992/2015
21-02NES	363932	13156/2015	28-03NES	363801	13995/2015

Registration Proceedings - Class Listing of Designs Published or Registered cont'd

Classification	Registration Number	Design Number	Classification	Registration Number	Design Number
28-03NES	363827	13987/2015	31-00	363894	14233/2015
28-03NES	363863	14259/2015	31-00	363897	14236/2015
29-02	363904	14229/2015	31-00	363905	14231/2015
31-00	363793	11365/2015	31-00	363906	14245/2015
31-00	363852	14241/2015			
31-00	363853	14242/2015			
31-00	363887	14227/2015			

(21) Design Number: **14179/2015**
(22) Date of Filing Application: **14 August 2015**
(24) Date from which industrial property rights may have effect: **14 August 2015**
(54) Product in respect of which the design is registered: **Cup**
(51) International Design Classification: **07-01C**
(74) Name(s) of Attorney(s): **Madderns**
(71) Name(s) and Address(s) of Applicant(s):
Greenface Packaging Ltd.
No. 23, Yongyi Rd. Taiping Dist. Taichung City, Taiwan
(72) Name(s) of Designer(s): **Che-Min Chu**
(45) Registration Date: **25 August 2015**
(30) Convention priority data:
(31) Number (32) Date (33) Country
104301823 06 Apr 2015 TAIWAN
(56) Related Art Documents: **Not Applicable**



(21) Design Number: **14181/2015**
(22) Date of Filing Application: **14 August 2015**
(24) Date from which industrial property rights may have effect: **02 June 2015**
(54) Product in respect of which the design is registered: **Trocar needle**
(51) International Design Classification: **24-02**
(74) Name(s) of Attorney(s): **PHILLIPS ORMONDE FITZPATRICK**
(71) Name(s) and Address(s) of Applicant(s):
Guangzhou T.K. Medical Instrument Co., Ltd.
A601 Guangzhou International Business Incubator Guangzhou Science
Park 510663 Guangzhou China
(72) Name(s) of Designer(s): **Xing Zhou and Shaoming Zhu and Linhai Liu and**
Jiajiang Wei and Huaping Xu and Lifei Luo
(45) Registration Date: **25 August 2015**
(30) Convention priority data:
(31) Number (32) Date (33) Country
201530067313.4 19 Mar 2015 CHINA
(62) Divisional of: **363815**
(56) Related Art Documents: **Not Applicable**
(57) Statement of Newness and Distinctiveness: **Those features of the trocar**
needle depicted in the representations that are new and distinctive are
the shape and/or configuration.



(21) Design Number: **14182/2015**
(22) Date of Filing Application: **14 August 2015**
(24) Date from which industrial property rights may have effect: **02 June 2015**
(54) Product in respect of which the design is registered: **Trocar sheath**
(51) International Design Classification: **24-02**
(74) Name(s) of Attorney(s): **PHILLIPS ORMONDE FITZPATRICK**
(71) Name(s) and Address(s) of Applicant(s):
Guangzhou T.K. Medical Instrument Co., Ltd.
A601 Guangzhou International Business Incubator Guangzhou Science
Park 510663 Guangzhou China

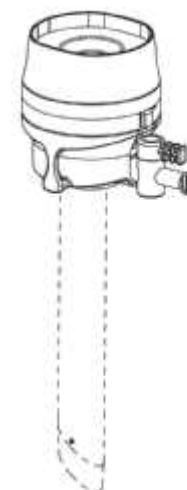

(72) Name(s) of Designer(s): **Xing Zhou and Shaoming Zhu and Linhai Liu and Jiajiang Wei and Huaping Xu and Lifei Luo**

(45) Registration Date: **25 August 2015**

(30) Convention priority data:

(31) Number	(32) Date	(33) Country
201530067261.0	19 Mar 2015	CHINA

(62) Divisional of: **363817**

(56) Related Art Documents: **Not Applicable**

(57) Statement of Newness and Distinctiveness: **Those features of the trocar sheath depicted in the representations that are new and distinctive are the shape and/or configuration. The feature shown in broken line is not part of the design and is to be disregarded when considering the overall impression of the design.**

(21) Design Number: **14183/2015**
(22) Date of Filing Application: **14 August 2015**
(24) Date from which industrial property rights may have effect: **02 June 2015**
(54) Product in respect of which the design is registered: **Trocar sheath**
(51) International Design Classification: **24-02**
(74) Name(s) of Attorney(s): **PHILLIPS ORMONDE FITZPATRICK**
(71) Name(s) and Address(s) of Applicant(s):
Guangzhou T.K. Medical Instrument Co., Ltd.
A601 Guangzhou International Business Incubator Guangzhou Science
Park 510663 Guangzhou China

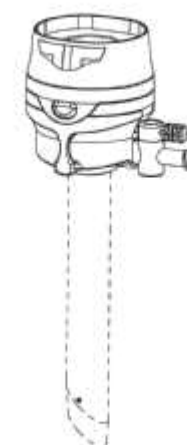

(72) Name(s) of Designer(s): **Xing Zhou and Shaoming Zhu and Linhai Liu and Jiajiang Wei and Huaping Xu and Lifei Luo**

(45) Registration Date: **25 August 2015**

(30) Convention priority data:

(31) Number	(32) Date	(33) Country
201530067261.0	19 Mar 2015	CHINA

(62) Divisional of: **363817**

(56) Related Art Documents: **Not Applicable**

(57) Statement of Newness and Distinctiveness: **Those features of the trocar sheath depicted in the representations that are new and distinctive are the shape and/or configuration. The feature shown in broken line is not part of the design and is to be disregarded when considering the overall impression of the design.**

- (21) Design Number: **14184/2015**
(22) Date of Filing Application: **14 August 2015**
(24) Date from which industrial property rights may have effect: **02 June 2015**
(54) Product in respect of which the design is registered: **Trocar sheath**
(51) International Design Classification: **24-02**
(74) Name(s) of Attorney(s): **PHILLIPS ORMONDE FITZPATRICK**
(71) Name(s) and Address(s) of Applicant(s):
Guangzhou T.K. Medical Instrument Co., Ltd.
A601 Guangzhou International Business Incubator Guangzhou Science
Park 510663 Guangzhou China
(72) Name(s) of Designer(s): **Xing Zhou and Shaoming Zhu and Linhai Liu and**
Jiajiang Wei and Huaping Xu and Lifei Luo
(45) Registration Date: **25 August 2015**
(30) Convention priority data:
(31) Number (32) Date (33) Country
201530067261.0 19 Mar 2015 CHINA
(62) Divisional of: **363817**
(56) Related Art Documents: **Not Applicable**
(57) Statement of Newness and Distinctiveness: **Those features of the trocar sheath depicted in the representations that are new and distinctive are the shape and/or configuration. The feature shown in broken line is not part of the design and is to be disregarded when considering the overall impression of the design.**

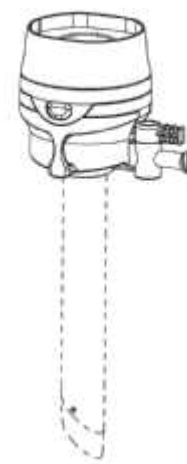

- (21) Design Number: **14185/2015**
(22) Date of Filing Application: **14 August 2015**
(24) Date from which industrial property rights may have effect: **02 June 2015**
(54) Product in respect of which the design is registered: **Trocar**
(51) International Design Classification: **24-02**
(74) Name(s) of Attorney(s): **PHILLIPS ORMONDE FITZPATRICK**
(71) Name(s) and Address(s) of Applicant(s):
Guangzhou T.K. Medical Instrument Co., Ltd.
A601 Guangzhou International Business Incubator Guangzhou Science
Park 510663 Guangzhou China
(72) Name(s) of Designer(s): **Xing Zhou and Shaoming Zhu and Linhai Liu and**
Jiajiang Wei and Huaping Xu and Lifei Luo
(45) Registration Date: **25 August 2015**
(30) Convention priority data:
(31) Number (32) Date (33) Country
201430493411.X 02 Dec 2014 CHINA
(62) Divisional of: **363816**
(56) Related Art Documents: **Not Applicable**
(57) Statement of Newness and Distinctiveness: **Those features of the trocar depicted in the representations that are new and distinctive are the shape and/or configuration.**



- (21) Design Number: **14186/2015**
(22) Date of Filing Application: **14 August 2015**
(24) Date from which industrial property rights may have effect: **02 June 2015**
(54) Product in respect of which the design is registered: **Trocar**
(51) International Design Classification: **24-02**
(74) Name(s) of Attorney(s): **PHILLIPS ORMONDE FITZPATRICK**
(71) Name(s) and Address(s) of Applicant(s):
Guangzhou T.K. Medical Instrument Co., Ltd.
A601 Guangzhou International Business Incubator Guangzhou Science
Park 510663 Guangzhou China
(72) Name(s) of Designer(s): **Xing Zhou and Shaoming Zhu and Linhai Liu and**
Jiajiang Wei and Huaping Xu and Lifei Luo
(45) Registration Date: **25 August 2015**
(30) Convention priority data:
(31) Number (32) Date (33) Country
201430493411.X 02 Dec 2014 CHINA
(62) Divisional of: **363816**
(56) Related Art Documents: **Not Applicable**
(57) Statement of Newness and Distinctiveness: **Those features of the trocar**
depicted in the representations that are new and distinctive are the shape
and/or configuration. The feature shown in broken lines is not part of the
design and is to be disregarded when considering the overall impression
of the design.

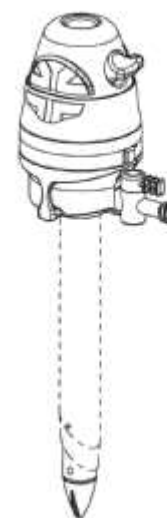

- (21) Design Number: **14187/2015**
(22) Date of Filing Application: **14 August 2015**
(24) Date from which industrial property rights may have effect: **02 June 2015**
(54) Product in respect of which the design is registered: **Trocar**
(51) International Design Classification: **24-02**
(74) Name(s) of Attorney(s): **PHILLIPS ORMONDE FITZPATRICK**
(71) Name(s) and Address(s) of Applicant(s):
Guangzhou T.K. Medical Instrument Co., Ltd.
A601 Guangzhou International Business Incubator Guangzhou Science
Park 510663 Guangzhou China
(72) Name(s) of Designer(s): **Xing Zhou and Shaoming Zhu and Linhai Liu and**
Jiajiang Wei and Huaping Xu and Lifei Luo
(45) Registration Date: **25 August 2015**
(30) Convention priority data:
(31) Number (32) Date (33) Country
201430493411.X 02 Dec 2014 CHINA
(62) Divisional of: **363816**
(56) Related Art Documents: **Not Applicable**
(57) Statement of Newness and Distinctiveness: **Those features of the trocar**
depicted in the representations that are new and distinctive are the shape
and/or configuration. The feature shown in broken lines is not part of the
design and is to be disregarded when considering the overall impression
of the design.

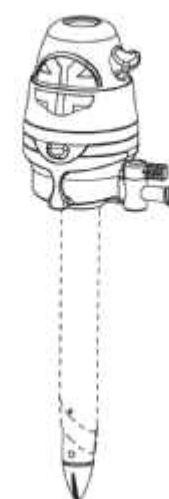

- (21) Design Number: **13902/2015**
(22) Date of Filing Application: **31 July 2015**
(24) Date from which industrial property rights may have effect: **31 July 2015**
(54) Product in respect of which the design is registered: **Seat**
(51) International Design Classification: **06-01C**
(74) Name(s) of Attorney(s):
(71) Name(s) and Address(s) of Applicant(s):

Ripple Iron Pty Ltd
21 Ellen St Moorooka Brisbane QLD 4105 Australia

(72) Name(s) of Designer(s): **Russell Hall**

(45) Registration Date: **25 August 2015**

(56) Related Art Documents: **Not Applicable**

(57) Statement of Newness and Distinctiveness: **Structural supports with arms sited one person in from outer edge enables 2 people adjacent each support to use the rests instead of 1 as is the case with end frames. The position of the support frames with a structural member in front of the timber seat member acts as a skateboard inhibitor without the addition of extra devices. The arm rest descends from the front of the seat to enable easy installation of the back rest. Clean simple aesthetic construction achieved by support frames of any metal and finish, coloured or not ; and use of durable and/or treated timbers. Bracing by cleats welded to seat support frame and then screwed to fixed seat members. Use of curved pipe section for front leg and armrest for comfortable grasping by hand.**



- (21) Design Number: **11365/2015**
(22) Date of Filing Application: **12 March 2015**
(24) Date from which industrial property rights may have effect: **12 March 2015**
(54) Product in respect of which the design is registered: **Citrus juicer**
(51) International Design Classification: **31-00**
(74) Name(s) of Attorney(s): **Molins & Co Pty Ltd**
(71) Name(s) and Address(s) of Applicant(s):

Breville Pty Limited
Suite 2 170-180 Bourke Rd Alexandria NSW 2015 Australia

(72) Name(s) of Designer(s): **Samuel Adeloju**

(45) Registration Date: **25 August 2015**

(56) Related Art Documents: **Not Applicable**

(57) Statement of Newness and Distinctiveness: **Newness is claimed in the features of shape and configuration of the citrus juicer as shown in the accompanying representations. Elements shown in dashed lines form no part of the design. The bottom plan view is not claimed as part of the design.**



(21) Design Number: **11546/2015**
(22) Date of Filing Application: **20 March 2015**
(24) Date from which industrial property rights may have effect: **20 March 2015**
(54) Product in respect of which the design is registered: **Handle assembly**
(51) International Design Classification: **08-06**
(74) Name(s) of Attorney(s): **Houlihan2**
(71) Name(s) and Address(s) of Applicant(s):
DAVID STUCKEY INVESTMENTS PTY LTD
C/- Pitcher Partners L19/15 William St Melbourne VIC 3000 Australia
(72) Name(s) of Designer(s): **Aditya Ramdhan and Asidin**
(45) Registration Date: **25 August 2015**
(56) Related Art Documents: **Not Applicable**
(57) Statement of Newness and Distinctiveness: **Newness and distinctiveness reside in the shape and/or configuration of a HANDLE ASSEMBLY as illustrated in the accompanying representations.**

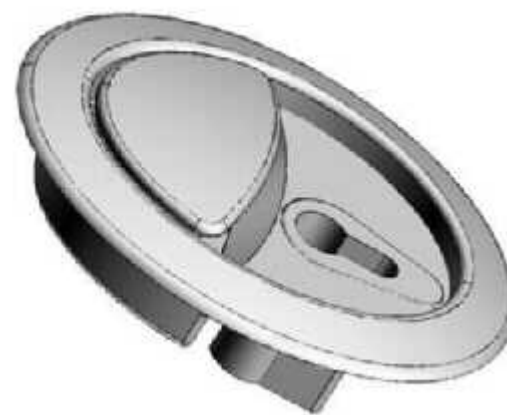

(21) Design Number: **11547/2015**
(22) Date of Filing Application: **20 March 2015**
(24) Date from which industrial property rights may have effect: **20 March 2015**
(54) Product in respect of which the design is registered: **Dish**
(51) International Design Classification: **08-06**
(74) Name(s) of Attorney(s): **Houlihan2**
(71) Name(s) and Address(s) of Applicant(s):
DAVID STUCKEY INVESTMENTS PTY LTD
C/- Pitcher Partners L19/15 William St Melbourne VIC 3000 Australia
(72) Name(s) of Designer(s): **Aditya Ramdhan and Asidin**
(45) Registration Date: **25 August 2015**
(56) Related Art Documents: **Not Applicable**
(57) Statement of Newness and Distinctiveness: **Newness and distinctiveness reside in the shape and/or configuration of a DISH for a handle assembly as illustrated in the accompanying representations.**

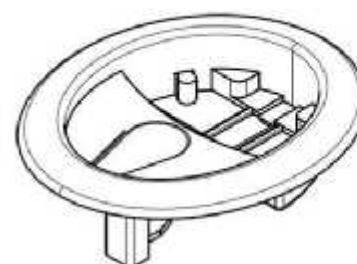

(21) Design Number: **13986/2015**

(22) Date of Filing Application: **06 August 2015**

(24) Date from which industrial property rights may have effect: **06 August 2015**

(54) Product in respect of which the design is registered: **Nail care instruments**

(51) International Design Classification: **28-03NES**

(74) Name(s) of Attorney(s): **Madderns**

(71) Name(s) and Address(s) of Applicant(s):

Reckitt Benckiser (Brands) Limited
103-105 Bath Road Slough Berkshire SL1 3UH United Kingdom

(72) Name(s) of Designer(s): **Martin Butler and Fiona Jones and Darren Morgan and Maartje Pel and Victoria Perrin and Jackie Tsang and Simon Woolley**

(45) Registration Date: **25 August 2015**

(30) Convention priority data:

(31) Number	(32) Date	(33) Country
002646588-0001	05 Mar 2015	OFFICE FOR HARMONISATION IN THE INTERNAL MARKET (OHIM)

(56) Related Art Documents: **Not Applicable**

(57) Statement of Newness and Distinctiveness: **The novelty resides in the shape and configuration of the designs**

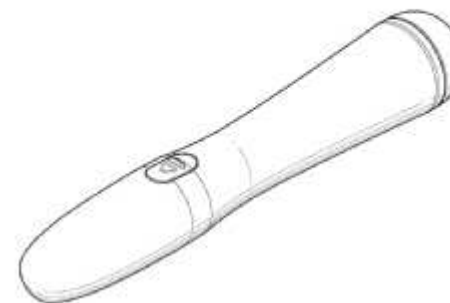

(21) Design Number: **13992/2015**

(22) Date of Filing Application: **06 August 2015**

(24) Date from which industrial property rights may have effect: **06 August 2015**

(54) Product in respect of which the design is registered: **Nail care instruments**

(51) International Design Classification: **28-03NES**

(74) Name(s) of Attorney(s): **Madderns**

(71) Name(s) and Address(s) of Applicant(s):

Reckitt Benckiser (Brands) Limited
103-105 Bath Road Slough Berkshire SL1 3UH United Kingdom

(72) Name(s) of Designer(s): **Martin Butler and Fiona Jones and Darren Morgan and Maartje Pel and Victoria Perrin and Jackie Tsang and Simon Woolley**

(45) Registration Date: **25 August 2015**

(30) Convention priority data:

(31) Number	(32) Date	(33) Country
002735712-0001	13 Jul 2015	OFFICE FOR HARMONISATION IN THE INTERNAL MARKET (OHIM)

(56) Related Art Documents: **Not Applicable**

(57) Statement of Newness and Distinctiveness: **The novelty resides in the shape and configuration of the designs**



(21) Design Number: **13949/2015**
(22) Date of Filing Application: **04 August 2015**
(24) Date from which industrial property rights may have effect: **04 August 2015**
(54) Product in respect of which the design is registered: **Back pain treatment and spinal protection device**
(51) International Design Classification: **24-04**
(74) Name(s) of Attorney(s): **EAGAR & MARTIN PTY LTD**
(71) Name(s) and Address(s) of Applicant(s):
Rosalie Dudkiewicz
101 Warren Road West Orange NJ, 07052 United States of America
Dariusz Dudkiewicz
101 Warren Road West Orange NJ, 07052 United States of America
(72) Name(s) of Designer(s): **Rosalie Dudkiewicz and Dariusz Dudkiewicz**
(45) Registration Date: **25 August 2015**
(30) Convention priority data:
(31) Number (32) Date (33) Country
29/516,851 06 Feb 2015 UNITED STATES OF AMERICA
(56) Related Art Documents: **Not Applicable**
(57) Statement of Newness and Distinctiveness: **Nil**



(21) Design Number: **13950/2015**
(22) Date of Filing Application: **04 August 2015**
(24) Date from which industrial property rights may have effect: **04 August 2015**
(54) Product in respect of which the design is registered: **Back pain treatment and spinal protection device**
(51) International Design Classification: **24-04**
(74) Name(s) of Attorney(s): **EAGAR & MARTIN PTY LTD**
(71) Name(s) and Address(s) of Applicant(s):
Rosalie Dudkiewicz
101 Warren Road West Orange NJ, 07052 United States of America
Dariusz Dudkiewicz
101 Warren Road West Orange NJ, 07052 United States of America
(72) Name(s) of Designer(s): **Rosalie Dudkiewicz and Dariusz Dudkiewicz**
(45) Registration Date: **25 August 2015**
(30) Convention priority data:
(31) Number (32) Date (33) Country
29/516,851 06 Feb 2015 UNITED STATES OF AMERICA
(56) Related Art Documents: **Not Applicable**
(57) Statement of Newness and Distinctiveness: **Nil**



(21) Design Number: **13951/2015**
(22) Date of Filing Application: **04 August 2015**
(24) Date from which industrial property rights may have effect: **04 August 2015**
(54) Product in respect of which the design is registered: **Back pain treatment and spinal protection device**
(51) International Design Classification: **24-04**
(74) Name(s) of Attorney(s): **EAGAR & MARTIN PTY LTD**
(71) Name(s) and Address(s) of Applicant(s):
Rosalie Dudkiewicz
101 Warren Road West Orange NJ, 07052 United States of America
Dariusz Dudkiewicz
101 Warren Road West Orange NJ, 07052 United States of America
(72) Name(s) of Designer(s): **Rosalie Dudkiewicz and Dariusz Dudkiewicz**
(45) Registration Date: **25 August 2015**
(30) Convention priority data:
(31) Number (32) Date (33) Country
29/516,851 06 Feb 2015 UNITED STATES OF AMERICA
(56) Related Art Documents: **Not Applicable**
(57) Statement of Newness and Distinctiveness: **Nil**



(21) Design Number: **13995/2015**
(22) Date of Filing Application: **06 August 2015**
(24) Date from which industrial property rights may have effect: **06 August 2015**
(54) Product in respect of which the design is registered: **Nail care instruments**
(51) International Design Classification: **28-03NES**
(74) Name(s) of Attorney(s): **Madderns**
(71) Name(s) and Address(s) of Applicant(s):
Reckitt Benckiser (Brands) Limited
103-105 Bath Road Slough Berkshire SL1 3UH United Kingdom
(72) Name(s) of Designer(s): **Martin Butler and Fiona Jones and Darren Morgan and Maartje Pel and Victoria Perrin and Jackie Tsang and Simon Woolley**
(45) Registration Date: **25 August 2015**
(30) Convention priority data:
(31) Number (32) Date (33) Country
002735712-0002 13 Jul 2015 OFFICE FOR HARMONISATION IN THE INTERNAL MARKET (OHIM)
(56) Related Art Documents: **Not Applicable**
(57) Statement of Newness and Distinctiveness: **The novelty resides in the shape and configuration of the designs.**



(21) Design Number: **14070/2015**
(22) Date of Filing Application: **08 August 2015**
(24) Date from which industrial property rights may have effect: **08 August 2015**
(54) Product in respect of which the design is registered: **Bottle**
(51) International Design Classification: **09-01NES**
(74) Name(s) of Attorney(s): **Pizzeys Patent and Trade Mark Attorneys Pty Ltd**
(71) Name(s) and Address(s) of Applicant(s):
Seventh Generation Ventures, Inc.
50 Late Street Burlington VT, 05401 United States of America
(72) Name(s) of Designer(s): **Karim Rashid and Brian D Schumacher and Derrick Paul Lawrence**
(45) Registration Date: **25 August 2015**
(30) Convention priority data:
(31) Number (32) Date (33) Country
29/517,567 13 Feb 2015 UNITED STATES OF AMERICA
(56) Related Art Documents: **Not Applicable**
(57) Statement of Newness and Distinctiveness: **Nil**

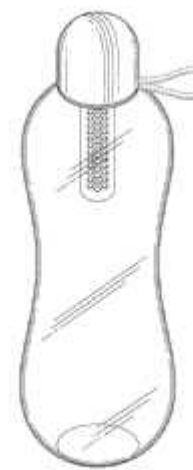

(21) Design Number: **14071/2015**
(22) Date of Filing Application: **08 August 2015**
(24) Date from which industrial property rights may have effect: **08 August 2015**
(54) Product in respect of which the design is registered: **Bottle with lid**
(51) International Design Classification: **07-01F, 09-01NES**
(74) Name(s) of Attorney(s): **Pizzeys Patent and Trade Mark Attorneys Pty Ltd**
(71) Name(s) and Address(s) of Applicant(s):
Seventh Generation Ventures, Inc
50 Late St Burlington VT, 05401 United States of America
(72) Name(s) of Designer(s): **Derrick Paul Lawrence and Aly Khalifa**
(45) Registration Date: **25 August 2015**
(30) Convention priority data:
(31) Number (32) Date (33) Country
29/517,576 13 Feb 2015 UNITED STATES OF AMERICA
(56) Related Art Documents: **Not Applicable**
(57) Statement of Newness and Distinctiveness: **Nil**



(21) Design Number: **14116/2015**
(22) Date of Filing Application: **11 August 2015**
(24) Date from which industrial property rights may have effect: **11 August 2015**
(54) Product in respect of which the design is registered: **Vehicle specification stand**
(51) International Design Classification: **12-16NES, 20-03C**
(74) Name(s) of Attorney(s):
(71) Name(s) and Address(s) of Applicant(s):
Andrew Molnar
8 Westpool Dr Hallam VIC 3803 Australia
(72) Name(s) of Designer(s): **Andrew Molnar**
(45) Registration Date: **25 August 2015**
(56) Related Art Documents: **Not Applicable**
(57) Statement of Newness and Distinctiveness: **A stand that sits under a vehicle's tyre, to display information of that vehicle.**

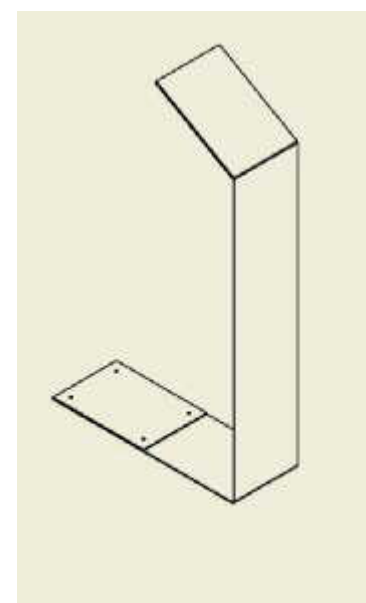

(21) Design Number: **14117/2015**
(22) Date of Filing Application: **11 August 2015**
(24) Date from which industrial property rights may have effect: **11 August 2015**
(54) Product in respect of which the design is registered: **Light**
(51) International Design Classification: **26-05D**
(74) Name(s) of Attorney(s): **IP Gateway Patent & Trade Mark Attorneys Pty Ltd**
(71) Name(s) and Address(s) of Applicant(s):
Landscape Forms, Inc.
431 Lawndale Avenue Kalamazoo Michigan, 49048 United States Of America
(72) Name(s) of Designer(s): **Francisco Gomez Paz**
(45) Registration Date: **25 August 2015**
(30) Convention priority data:
(31) Number (32) Date (33) Country
29/518,730 26 Feb 2015 UNITED STATES OF AMERICA
(56) Related Art Documents: **Not Applicable**
(57) Statement of Newness and Distinctiveness: **Newness and distinctiveness reside in the visual features of shape and configuration of the product as shown in solid lines in the representations. Visual features shown in broken dashed lines should be given minimum regard.**



(21) Design Number: **14118/2015**
(22) Date of Filing Application: **11 August 2015**
(24) Date from which industrial property rights may have effect: **11 August 2015**
(54) Product in respect of which the design is registered: **Basket**
(51) International Design Classification: **09-04, 03-01A**
(74) Name(s) of Attorney(s): **Shelston IP**
(71) Name(s) and Address(s) of Applicant(s):
CURVER Luxembourg Sarl
Z.I. Haneboesch Neidercorn L4562 Luxembourg
(72) Name(s) of Designer(s): **Nikolai Duvigneau**
(45) Registration Date: **25 August 2015**
(30) Convention priority data:
(31) Number (32) Date (33) Country
56589 12 Feb 2015 ISRAEL
(56) Related Art Documents: **Not Applicable**
(57) Statement of Newness and Distinctiveness: **Newness and distinctiveness reside in the features of shape and/or configuration of a BASKET as illustrated in the accompanying representations.**



(21) Design Number: **14120/2015**
(22) Date of Filing Application: **11 August 2015**
(24) Date from which industrial property rights may have effect: **11 August 2015**
(54) Product in respect of which the design is registered: **Key blank**
(51) International Design Classification: **08-07**
(74) Name(s) of Attorney(s):
(71) Name(s) and Address(s) of Applicant(s):
AUSTRALIAN LOCK COMPANY PTY LTD
17 Doyle Ave UnanderraNSW 2526 Australia
(72) Name(s) of Designer(s): **Changyu You**
(45) Registration Date: **25 August 2015**
(56) Related Art Documents: **Not Applicable**
(57) Statement of Newness and Distinctiveness: **Newness and distinctiveness is claimed in the shape and configuration of the key blade as represented in solid lines in the drawings. In assessing newness and distinctiveness, no regards should be had of the features represented in broken lines, including the key head.**

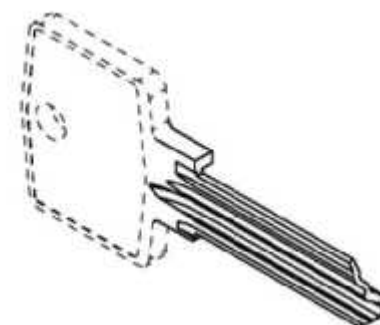

(21) Design Number: **14121/2015**
(22) Date of Filing Application: **11 August 2015**
(24) Date from which industrial property rights may have effect: **11 August 2015**
(54) Product in respect of which the design is registered: **Basket**
(51) International Design Classification: **09-04**
(74) Name(s) of Attorney(s): **Shelston IP**
(71) Name(s) and Address(s) of Applicant(s):
CURVER Luxembourg Sarl
Z.I. Haneboesch Neidercorn L4562 Luxembourg
(72) Name(s) of Designer(s): **Nikolai Duvigneau**
(45) Registration Date: **25 August 2015**
(30) Convention priority data:
(31) Number (32) Date (33) Country
56589 12 Feb 2015 ISRAEL
(56) Related Art Documents: **Not Applicable**
(57) Statement of Newness and Distinctiveness: **Newness and distinctiveness reside in the features of shape and/or configuration of a BASKET as illustrated in the accompanying representations.**



(21) Design Number: **14122/2015**
(22) Date of Filing Application: **11 August 2015**
(24) Date from which industrial property rights may have effect: **11 August 2015**
(54) Product in respect of which the design is registered: **Basket**
(51) International Design Classification: **09-04**
(74) Name(s) of Attorney(s): **Shelston IP**
(71) Name(s) and Address(s) of Applicant(s):
CURVER Luxembourg Sarl
Z.I. Haneboesch Neidercorn L4562 Luxembourg
(72) Name(s) of Designer(s): **Nikolai Duvigneau**
(45) Registration Date: **25 August 2015**
(30) Convention priority data:
(31) Number (32) Date (33) Country
56589 12 Feb 2015 ISRAEL
(56) Related Art Documents: **Not Applicable**
(57) Statement of Newness and Distinctiveness: **Newness and distinctiveness reside in the features of shape and/or configuration of a BASKET as illustrated in the accompanying representations.**



- (21) Design Number: **14123/2015**
(22) Date of Filing Application: **11 August 2015**
(24) Date from which industrial property rights may have effect: **11 August 2015**
(54) Product in respect of which the design is registered: **Basket**
(51) International Design Classification: **09-04**
(74) Name(s) of Attorney(s): **Shelston IP**
(71) Name(s) and Address(s) of Applicant(s):
CURVER Luxembourg Sarl
Z.I. Haneboesch Neidercorn L4562 Luxembourg
(72) Name(s) of Designer(s): **Nikolai Duvigneau**
(45) Registration Date: **25 August 2015**
(30) Convention priority data:
(31) Number (32) Date (33) Country
56589 12 Feb 2015 ISRAEL
(56) Related Art Documents: **Not Applicable**
(57) Statement of Newness and Distinctiveness: **Newness and distinctiveness reside in the features of shape and/or configuration of a BASKET as illustrated in the accompanying representations.**



- (21) Design Number: **14127/2015**
(22) Date of Filing Application: **12 August 2015**
(24) Date from which industrial property rights may have effect: **12 August 2015**
(54) Product in respect of which the design is registered: **Mattress**
(51) International Design Classification: **06-09**
(74) Name(s) of Attorney(s):
(71) Name(s) and Address(s) of Applicant(s):
PUMP FACTORY PTY LTD
PO BOX 4181 Narre Warren South VIC 3805 Australia
(72) Name(s) of Designer(s): **Zoran Kacavenda**
(45) Registration Date: **25 August 2015**
(56) Related Art Documents: **Not Applicable**
(57) Statement of Newness and Distinctiveness: **The newness and distinctiveness of the design resides in the long horizontal carry strap on each side of the mattress with 3 vertical carry straps as well as shown in the continuous lines in the accompanying representations.**

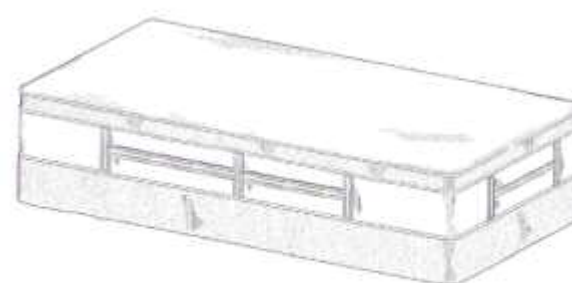

(21) Design Number: **14128/2015**
(22) Date of Filing Application: **12 August 2015**
(24) Date from which industrial property rights may have effect: **12 August 2015**
(54) Product in respect of which the design is registered: **Bottle**
(51) International Design Classification: **09-01H**
(74) Name(s) of Attorney(s): **Pizzeys Patent and Trade Mark Attorneys Pty Ltd**
(71) Name(s) and Address(s) of Applicant(s):
Graham Packaging Company, L.P.
2401 Pleasant Valley Road York PA, 17402 United States of America
(72) Name(s) of Designer(s): **Stephen R Guerin and Sheldon E Yourist**
(45) Registration Date: **25 August 2015**
(30) Convention priority data:
(31) Number (32) Date (33) Country
29/523,572 10 Apr 2015 UNITED STATES OF AMERICA
(56) Related Art Documents: **Not Applicable**
(57) Statement of Newness and Distinctiveness: **The newness and distinctiveness of the design resides in the features of shape and/or configuration shown in unbroken lines in the accompanying representations. (if required, see Convention document)**



(21) Design Number: **14130/2015**
(22) Date of Filing Application: **12 August 2015**
(24) Date from which industrial property rights may have effect: **12 August 2015**
(54) Product in respect of which the design is registered: **Pacifier**
(51) International Design Classification: **24-04**
(74) Name(s) of Attorney(s): **FB Rice**
(71) Name(s) and Address(s) of Applicant(s):
Koninklijke Philips N.V.
High Tech Campus 5 5656 AE Eindhoven The Netherlands
(72) Name(s) of Designer(s): **Jason Eaton and Ron Roth**
(45) Registration Date: **25 August 2015**
(30) Convention priority data:
(31) Number (32) Date (33) Country
002630772-0001 11 Feb 2015 OFFICE FOR HARMONISATION IN THE INTERNAL MARKET (OHIM)
(56) Related Art Documents: **Not Applicable**
(57) Statement of Newness and Distinctiveness: **Newness and distinctiveness reside in the features of shape and configuration of the design as shown in the representations.**



(21) Design Number: **12639/2015**
(22) Date of Filing Application: **21 May 2015**
(24) Date from which industrial property rights may have effect: **21 May 2015**
(54) Product in respect of which the design is registered: **RFID tag inlay**
(51) International Design Classification: **14-03NES**
(74) Name(s) of Attorney(s): **Elliptic Legal & Patent Services**
(71) Name(s) and Address(s) of Applicant(s):
Megabyte Limited
Unit 301-302, 3/F, Building 12W, No. 12 Science Park West Avenue, Hong Kong Science Park Shatin New Territories Hong Kong
(72) Name(s) of Designer(s): **Chun Sing Matthew Man**
(45) Registration Date: **25 August 2015**
(56) Related Art Documents: **Not Applicable**
(57) Statement of Newness and Distinctiveness: **Nil**

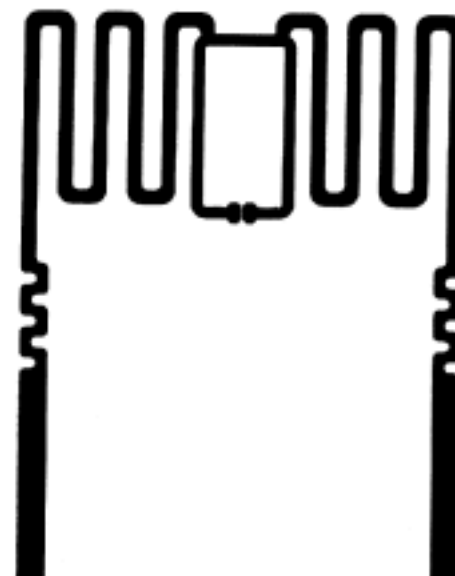

(21) Design Number: **12804/2015**
(22) Date of Filing Application: **02 June 2015**
(24) Date from which industrial property rights may have effect: **02 June 2015**
(54) Product in respect of which the design is registered: **Trocar needle**
(51) International Design Classification: **24-01**
(74) Name(s) of Attorney(s): **PHILLIPS ORMONDE FITZPATRICK**
(71) Name(s) and Address(s) of Applicant(s):
Guangzhou T.K. Medical Instrument Co., Ltd.
A601 Guangzhou International Business Incubator Guangzhou Science Park 510663 Guangzhou China
(72) Name(s) of Designer(s): **Xing Zhou and Shaoming Zhu and Linhai Liu and Jiajiang Wei and Huaping Xu and Lifei Luo**
(45) Registration Date: **25 August 2015**
(30) Convention priority data:
(31) Number (32) Date (33) Country
201530067313.4 19 Mar 2015 CHINA
(56) Related Art Documents: **Not Applicable**
(57) Statement of Newness and Distinctiveness: **Those features of the trocar needle depicted in the representations that are new and distinctive are the shape and/or configuration.**



(21) Design Number: **12805/2015**
(22) Date of Filing Application: **02 June 2015**
(24) Date from which industrial property rights may have effect: **02 June 2015**
(54) Product in respect of which the design is registered: **Trocar**
(51) International Design Classification: **24-01**
(74) Name(s) of Attorney(s): **PHILLIPS ORMONDE FITZPATRICK**
(71) Name(s) and Address(s) of Applicant(s):
Guangzhou T.K. Medical Instrument Co., Ltd.
A601 Guangzhou International Business Incubator Guangzhou Science
Park 510663 Guangzhou China
(72) Name(s) of Designer(s): **Xing Zhou and Shaoming Zhu and Linhai Liu and**
Jiajiang Wei and Huaping Xu and Lifei Luo
(45) Registration Date: **25 August 2015**
(30) Convention priority data:
(31) Number (32) Date (33) Country
201430493411.X 02 Dec 2014 CHINA
(56) Related Art Documents: **Not Applicable**
(57) Statement of Newness and Distinctiveness: **Those features of the trocar**
depicted in the representations that are new and distinctive are the shape
and/or configuration. The features shown in broken lines are not part
of the design and are to be disregarded when considering the overall
impression of the design.

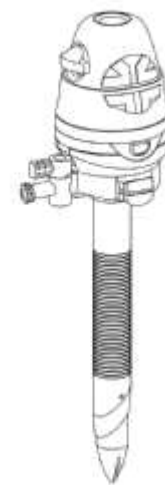

(21) Design Number: **12806/2015**
(22) Date of Filing Application: **02 June 2015**
(24) Date from which industrial property rights may have effect: **02 June 2015**
(54) Product in respect of which the design is registered: **Trocar sheath**
(51) International Design Classification: **24-01**
(74) Name(s) of Attorney(s): **PHILLIPS ORMONDE FITZPATRICK**
(71) Name(s) and Address(s) of Applicant(s):
Guangzhou T.K. Medical Instrument Co., Ltd.
A601 Guangzhou International Business Incubator Guangzhou Science
Park 510663 Guangzhou China
(72) Name(s) of Designer(s): **Xing Zhou and Shaoming Zhu and Linhai Liu and**
Jiajiang Wei and Huaping Xu and Lifei Luo
(45) Registration Date: **25 August 2015**
(30) Convention priority data:
(31) Number (32) Date (33) Country
201530067261.0 19 Mar 2015 CHINA
(56) Related Art Documents: **Not Applicable**
(57) Statement of Newness and Distinctiveness: **Those features of the trocar**
sheath depicted in the representations that are new and distinctive are
the shape and/or configuration. The features shown in broken lines are
not part of the design and are to be disregarded when considering the
overall impression of the design.

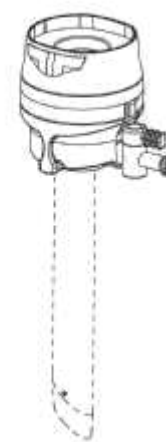

- (21) Design Number: **12871/2015**
(22) Date of Filing Application: **09 June 2015**
(24) Date from which industrial property rights may have effect: **09 June 2015**
(54) Product in respect of which the design is registered: **Hair drying device**
(51) International Design Classification: **28-03B**
(74) Name(s) of Attorney(s):
(71) Name(s) and Address(s) of Applicant(s):

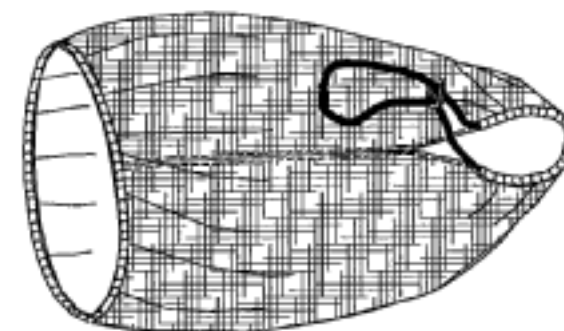

- A P Walker Design Services Pty. Limited**
PO BOX 184 Wahroonga NSW 2076 Australia
(72) Name(s) of Designer(s): **Aurora Walker and Andrew P Walker**
(45) Registration Date: **25 August 2015**
(56) Related Art Documents: **Not Applicable**
(57) Statement of Newness and Distinctiveness: **The multi-functional hair drying net and turban towel for upright application may be used on its own or in combination with a hand held hair dryer. Useful for managing dry and wet hair, to absorb water from wet hair after washing, swimming, or anytime the hair is wet, thereby avoiding dripping of water on the face, neck, or clothes. Used over dry hair to keep hair off the face, back and neck when applying make-up and treatments to the face. When required to dry hair by electrical means the device can be connected to a commercially available hair dryer and used as a conduit to direct warm air into the net cavity and dry hair using electrical means. It can be used to keep hair dry and off the face and back in the bath, shower, Jacuzzi, spa or steam bath.**

- (21) Design Number: **13327/2015**
(22) Date of Filing Application: **01 July 2015**
(24) Date from which industrial property rights may have effect: **01 July 2015**
(54) Product in respect of which the design is registered: **Bottle gift tag for wine, champagne, liquor.**
(51) International Design Classification: **19-08**
(74) Name(s) of Attorney(s):
(71) Name(s) and Address(s) of Applicant(s):

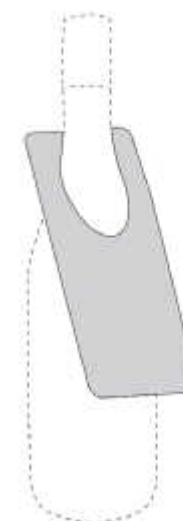

- Maja Wolnik**
43B/2 Esplanade West Port Melbourne VIC 3207 Australia
(72) Name(s) of Designer(s): **Maja Wolnik**
(45) Registration Date: **25 August 2015**
(56) Related Art Documents: **Not Applicable**
(57) Statement of Newness and Distinctiveness: **The newness and distinctiveness of the design resides in the shape of the oval hole in the card which allows it to sit on the bottle in a distinctive and presentable way to show off the design and also includes space on the back of the card for writing greetings.**

- (21) Design Number: **13417/2015**
(22) Date of Filing Application: **07 July 2015**
(24) Date from which industrial property rights may have effect: **07 July 2015**
(54) Product in respect of which the design is registered: **A pocket for jeans**
(51) International Design Classification: **02-02B**
(74) Name(s) of Attorney(s):
(71) Name(s) and Address(s) of Applicant(s):

Lukas Vincent
38 Deborah Dr Baxter VIC 3911 Australia

(72) Name(s) of Designer(s): **Lukas Vincent**

(45) Registration Date: **25 August 2015**

(56) Related Art Documents: **Not Applicable**

(57) Statement of Newness and Distinctiveness: **The newness and distinctiveness of this design resides in the number of sides added to the overall shape of the pocket. A traditional jean back hip pocket consists of 5 sides, whereas here, a 6th edge has carefully been added, giving the shape an instant sense of newness. In addition, the outer row of twin needle stitching follows each edge of the pocket, while the inner row impresses the traditional 5 edged shape. This gives the wearer the illusion of the pocket being traditional, yet the overall impression of the design still registers as something completely different.**

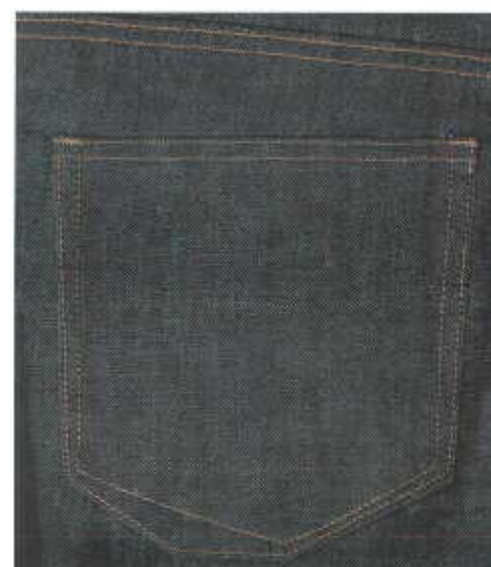

- (21) Design Number: **12968/2015**
(22) Date of Filing Application: **12 June 2015**
(24) Date from which industrial property rights may have effect: **12 June 2015**
(54) Product in respect of which the design is registered: **Bottle label**
(51) International Design Classification: **19-08**
(74) Name(s) of Attorney(s): **Davies Collison Cave**
(71) Name(s) and Address(s) of Applicant(s):

Nongfu Spring Co., Ltd.
No. 181, Geyazhuang Xihu District, Hangzhou Zhejiang, 310024 China

(72) Name(s) of Designer(s): **Shanshan Zhong**

(45) Registration Date: **25 August 2015**

(30) Convention priority data:

(31) Number	(32) Date	(33) Country
201530006235.7	09 Jan 2015	CHINA

(56) Related Art Documents: **Not Applicable**

(57) Statement of Newness and Distinctiveness: **Newness and distinctiveness is claimed in the visual features of a bottle label as shown in the representation, but not in the colour of the bottle label.**



(21) Design Number: **12969/2015**
(22) Date of Filing Application: **12 June 2015**
(24) Date from which industrial property rights may have effect: **12 June 2015**
(54) Product in respect of which the design is registered: **Bottle label**
(51) International Design Classification: **19-08**
(74) Name(s) of Attorney(s): **Davies Collison Cave**
(71) Name(s) and Address(s) of Applicant(s):
Nongfu Spring Co., Ltd.
No. 181, Geyazhuang Xihu District, Hangzhou Zhejiang, 310024 China
(72) Name(s) of Designer(s): **Yi Lu**
(45) Registration Date: **25 August 2015**
(30) Convention priority data:
(31) Number (32) Date (33) Country
201530006231.9 09 Jan 2015 CHINA
(56) Related Art Documents: **Not Applicable**
(57) Statement of Newness and Distinctiveness: **Newness and distinctiveness is claimed in the visual features of a bottle label as shown in the representation, but not in the colour of the bottle label.**



(21) Design Number: **13074/2015**
(22) Date of Filing Application: **18 June 2015**
(24) Date from which industrial property rights may have effect: **18 June 2015**
(54) Product in respect of which the design is registered: **Display screen with graphical user interface**
(51) International Design Classification: **14-02**
(74) Name(s) of Attorney(s): **Pizzey's Patent and Trade Mark Attorneys Pty Ltd**
(71) Name(s) and Address(s) of Applicant(s):
Gamblit Gaming, LLC
700 N. Central Blvd. 7th Floor Glendale CA, 91203 United States of America
(72) Name(s) of Designer(s): **Mark Paulik**
(45) Registration Date: **25 August 2015**
(30) Convention priority data:
(31) Number (32) Date (33) Country
29/528,277 27 May 2015 UNITED STATES OF AMERICA
(56) Related Art Documents: **Not Applicable**
(57) Statement of Newness and Distinctiveness: **Nil**

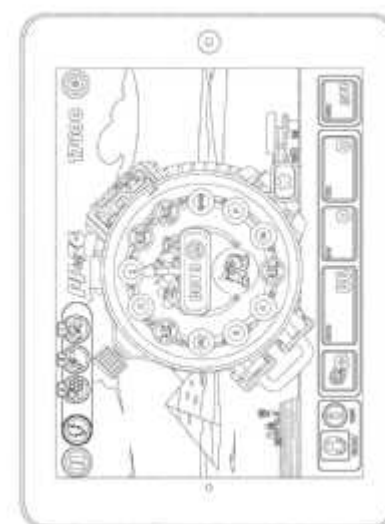

- (21) Design Number: **14105/2015**
(22) Date of Filing Application: **11 August 2015**
(24) Date from which industrial property rights may have effect: **11 August 2015**
(54) Product in respect of which the design is registered: **Seal**
(51) International Design Classification: **23-01A**
(74) Name(s) of Attorney(s): **IP Gateway Patent & Trade Mark Attorneys Pty Ltd**
(71) Name(s) and Address(s) of Applicant(s):
Haigh Tooling Limited
15 Dalziel Place Woolston Christchurch 8023 New Zealand
(72) Name(s) of Designer(s): **Brian Haigh**
(45) Registration Date: **25 August 2015**
(56) Related Art Documents: **Not Applicable**
(57) Statement of Newness and Distinctiveness: **The particular visual features of the design which are new and distinctive are the shape or configuration of the seal.**

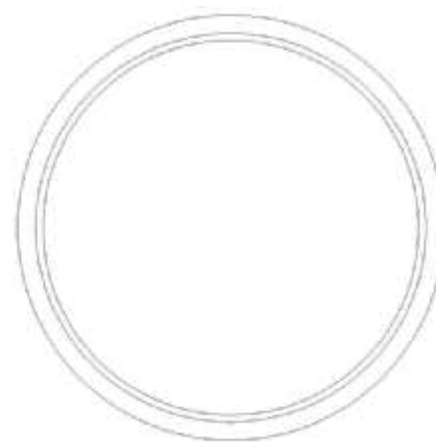

- (21) Design Number: **13290/2015**
(22) Date of Filing Application: **30 June 2015**
(24) Date from which industrial property rights may have effect: **30 June 2015**
(54) Product in respect of which the design is registered: **Wearable semiochemical retainer**
(51) International Design Classification: **03-01NES**
(74) Name(s) of Attorney(s): **FB Rice**
(71) Name(s) and Address(s) of Applicant(s):
Sterling International Inc.
3808 North Sullivan Road Bldg. 16BV Spokane Washington, 99216
United States of America
(72) Name(s) of Designer(s): **Marc Chapin and Qing-He Zhang and Rodney G. Schneidmiller**
(45) Registration Date: **25 August 2015**
(30) Convention priority data:
(31) Number (32) Date (33) Country
29/514280 09 Jan 2015 UNITED STATES OF AMERICA
(56) Related Art Documents: **Not Applicable**
(57) Statement of Newness and Distinctiveness: **Newness and distinctiveness reside in the features of shape and configuration of the design as shown in the representations.**



(21) Design Number: **14156/2015**
(22) Date of Filing Application: **13 August 2015**
(24) Date from which industrial property rights may have effect: **13 August 2015**
(54) Product in respect of which the design is registered: **Bottle**
(51) International Design Classification: **09-01NES**
(74) Name(s) of Attorney(s): **HODGKINSON McINNES PATENTS**
(71) Name(s) and Address(s) of Applicant(s):

SIG Technology AG
Laufengasse 18 Neuhausen am Rheinflall 8212 Switzerland

(72) Name(s) of Designer(s): **Matthias Dammers**

(45) Registration Date: **25 August 2015**

(30) Convention priority data:

(31) Number	(32) Date	(33) Country
DE 40 2015 100 345.1	15 Apr 2015	GERMANY

(56) Related Art Documents: **Not Applicable**

(57) Statement of Newness and Distinctiveness: **Newness and distinctiveness is claimed in the shape and configuration of a bottle as shown in the representations.**



(21) Design Number: **13987/2015**
(22) Date of Filing Application: **06 August 2015**
(24) Date from which industrial property rights may have effect: **06 August 2015**
(54) Product in respect of which the design is registered: **Nail care instruments**
(51) International Design Classification: **28-03NES**
(74) Name(s) of Attorney(s): **Madderns**
(71) Name(s) and Address(s) of Applicant(s):

Reckitt Benckiser (Brands) Limited
103-105 Bath Road Slough Berkshire SL1 3UH United Kingdom

(72) Name(s) of Designer(s): **Martin Butler and Fiona Jones and Darren Morgan and Maartje Pel and Victoria Perrin and Jackie Tsang and Simon Woolley**

(45) Registration Date: **26 August 2015**

(30) Convention priority data:

(31) Number	(32) Date	(33) Country
002646588-0002	05 Mar 2015	OFFICE FOR HARMONISATION IN THE INTERNAL MARKET (OHIM)

(56) Related Art Documents: **Not Applicable**

(57) Statement of Newness and Distinctiveness: **The novelty resides in the shape and configuration of the designs**

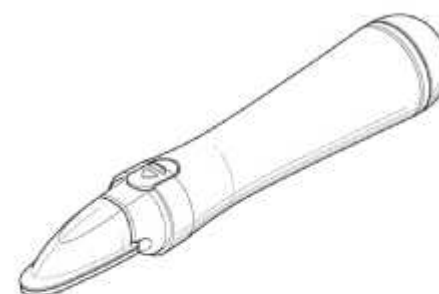

(21) Design Number: **14150/2015**
(22) Date of Filing Application: **13 August 2015**
(24) Date from which industrial property rights may have effect: **13 August 2015**
(54) Product in respect of which the design is registered: **Electric toothbrush**
(51) International Design Classification: **04-02**
(74) Name(s) of Attorney(s): **FB Rice**
(71) Name(s) and Address(s) of Applicant(s):
Colgate-Palmolive Company
300 Park Avenue New York NY 10022 United States of America
(72) Name(s) of Designer(s): **Takashi Shigeno and Kazuya Andachi and Feilang Tseng**
(45) Registration Date: **26 August 2015**
(30) Convention priority data:
(31) Number (32) Date (33) Country
2015-004297 27 Feb 2015 JAPAN
(56) Related Art Documents: **Not Applicable**
(57) Statement of Newness and Distinctiveness: **Newness and distinctiveness reside in the features of the design shown in solid lines in representations excluding those features shown in broken lines.**



(21) Design Number: **14151/2015**
(22) Date of Filing Application: **13 August 2015**
(24) Date from which industrial property rights may have effect: **13 August 2015**
(54) Product in respect of which the design is registered: **Bottle**
(51) International Design Classification: **09-01H**
(74) Name(s) of Attorney(s): **HODGKINSON McINNES PATENTS**
(71) Name(s) and Address(s) of Applicant(s):
SIG Technology AG
Laufengasse 18 Neuhausen am Rheinfall 8212 Switzerland
(72) Name(s) of Designer(s): **Matthias Dammers**
(45) Registration Date: **26 August 2015**
(30) Convention priority data:
(31) Number (32) Date (33) Country
DE 40 2015 100 15 Apr 2015 GERMANY
345.1
(56) Related Art Documents: **Not Applicable**
(57) Statement of Newness and Distinctiveness: **Newness and distinctiveness is claimed in the shape and configuration of a bottle as shown in the representations.**

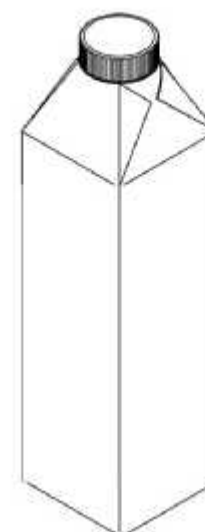

(21) Design Number: **14153/2015**
(22) Date of Filing Application: **13 August 2015**
(24) Date from which industrial property rights may have effect: **13 August 2015**
(54) Product in respect of which the design is registered: **Bottle**
(51) International Design Classification: **09-01K**
(74) Name(s) of Attorney(s): **HODGKINSON McINNES PATENTS**
(71) Name(s) and Address(s) of Applicant(s):

SIG Technology AG
Laufengasse 18 Neuhausen am Rheinfall 8212 Switzerland

(72) Name(s) of Designer(s): **Matthias Dammers**

(45) Registration Date: **26 August 2015**

(30) Convention priority data:

(31) Number	(32) Date	(33) Country
DE 40 2015 100 345.1	15 Apr 2015	GERMANY

(56) Related Art Documents: **Not Applicable**

(57) Statement of Newness and Distinctiveness: **Newness and distinctiveness is claimed in the shape and configuration of a bottle as shown in the representations.**

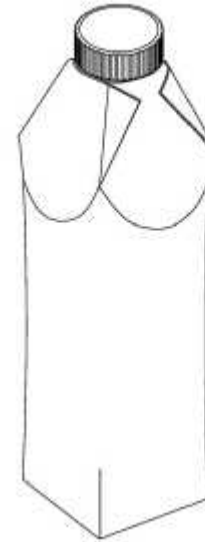

(21) Design Number: **14188/2015**
(22) Date of Filing Application: **14 August 2015**
(24) Date from which industrial property rights may have effect: **02 June 2015**
(54) Product in respect of which the design is registered: **Trocar**
(51) International Design Classification: **24-02**
(74) Name(s) of Attorney(s): **PHILLIPS ORMONDE FITZPATRICK**
(71) Name(s) and Address(s) of Applicant(s):

Guangzhou T.K. Medical Instrument Co., Ltd.
A601 Guangzhou International Business Incubator Guangzhou Science
Park 510663 Guangzhou China

(72) Name(s) of Designer(s): **Xing Zhou and Shaoming Zhu and Linhai Liu and Jiajiang Wei and Huaping Xu and Lifei LUO**

(45) Registration Date: **26 August 2015**

(30) Convention priority data:

(31) Number	(32) Date	(33) Country
201430493411.X	02 Dec 2014	CHINA

(62) Divisional of: **363816**

(56) Related Art Documents: **Not Applicable**

(57) Statement of Newness and Distinctiveness: **Those features of the trocar depicted in the representations that are new and distinctive are the shape and/or configuration. The feature shown in broken lines is not part of the design and is to be disregarded when considering the overall impression of the design.**

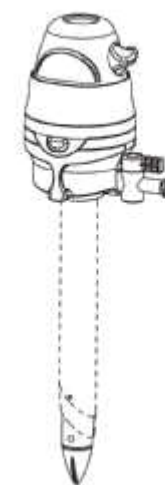

- (21) Design Number: **13078/2015**
(22) Date of Filing Application: **18 June 2015**
(24) Date from which industrial property rights may have effect: **18 June 2015**
(54) Product in respect of which the design is registered: **Table lamp**
(51) International Design Classification: **26-05B**
(74) Name(s) of Attorney(s):
(71) Name(s) and Address(s) of Applicant(s):
Spaceleft Pty Ltd
U2/15-19 Anthony St Melbourne VIC 3000 Australia
(72) Name(s) of Designer(s): **Ross Gardam**
(45) Registration Date: **26 August 2015**
(56) Related Art Documents: **Not Applicable**
(57) Statement of Newness and Distinctiveness: **The overall curved shape of the lampshade in combination with the cylindrical body component is unique and distinctive. The shade can tilt and rotate around the cylindrical body, giving it distinctly different appearance as it rotates.**

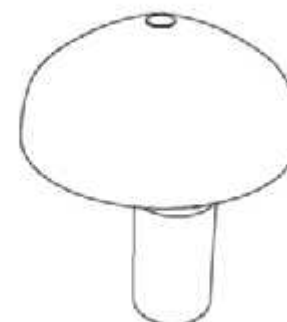

- (21) Design Number: **13304/2015**
(22) Date of Filing Application: **29 June 2015**
(24) Date from which industrial property rights may have effect: **29 June 2015**
(54) Product in respect of which the design is registered: **Thermometer stand**
(51) International Design Classification: **10-04**
(74) Name(s) of Attorney(s):
(71) Name(s) and Address(s) of Applicant(s):
Keith Moffatt Shaw
105 Aubreen St Collaroy Plateau NSW 2097 Australia
(72) Name(s) of Designer(s): **Keith Moffatt Shaw**
(45) Registration Date: **26 August 2015**
(56) Related Art Documents: **Not Applicable**
(57) Statement of Newness and Distinctiveness: **1. Tool for checking temperates in airconditioned rooms unobtrusively 2. tool can be located in "people occupied spaces" 600mm from walls 3. tool for checking coldest and hottest spaces in houses + similar 4. tool for checking temperates where nails and screws in building fabric are not permitted. eg commercial offices**

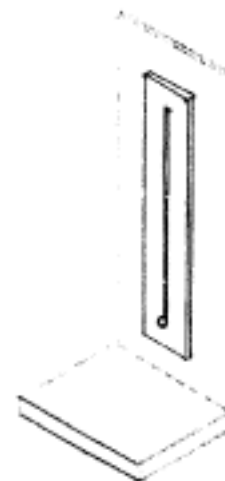

(21) Design Number: **14129/2015**
(22) Date of Filing Application: **12 August 2015**
(24) Date from which industrial property rights may have effect: **12 August 2015**
(54) Product in respect of which the design is registered: **Bottle**
(51) International Design Classification: **09-01H**
(74) Name(s) of Attorney(s): **Pizzeys Patent and Trade Mark Attorneys Pty Ltd**
(71) Name(s) and Address(s) of Applicant(s):
Graham Packaging Company, L.P.
2401 Pleasant Valley Road York PA, 17402 United States of America
(72) Name(s) of Designer(s): **Sheldon E Yourist and Stephen R Guerin**
(45) Registration Date: **26 August 2015**
(30) Convention priority data:
(31) Number (32) Date (33) Country
29/523,573 10 Apr 2015 UNITED STATES OF AMERICA
(56) Related Art Documents: **Not Applicable**
(57) Statement of Newness and Distinctiveness: **The newness and distinctiveness of the design resides in the features of shape and/or configuration shown in unbroken lines in the accompanying representations.**



(21) Design Number: **14119/2015**
(22) Date of Filing Application: **11 August 2015**
(24) Date from which industrial property rights may have effect: **11 August 2015**
(54) Product in respect of which the design is registered: **Path light**
(51) International Design Classification: **26-05NES, 26-03**
(74) Name(s) of Attorney(s): **IP Gateway Patent & Trade Mark Attorneys Pty Ltd**
(71) Name(s) and Address(s) of Applicant(s):
Landscape Forms, Inc.
431 Lawndale Avenue Kalamazoo Michigan, 49048 United States Of America
(72) Name(s) of Designer(s): **Francisco Gomez Paz**
(45) Registration Date: **26 August 2015**
(30) Convention priority data:
(31) Number (32) Date (33) Country
29/518,735 26 Feb 2015 UNITED STATES OF AMERICA
(56) Related Art Documents: **Not Applicable**
(57) Statement of Newness and Distinctiveness: **Newness and distinctiveness reside in the visual features of shape and configuration of the product as shown in the representations.**



- (21) Design Number: **14124/2015**
(22) Date of Filing Application: **11 August 2015**
(24) Date from which industrial property rights may have effect: **11 August 2015**
(54) Product in respect of which the design is registered: **Tire for a car**
(51) International Design Classification: **12-15A**
(74) Name(s) of Attorney(s): **WATERMARK PATENT AND TRADE MARKS ATTORNEYS**
(71) Name(s) and Address(s) of Applicant(s):
Kumho Tire Co., Inc.
(Sochon-dong) 658 Eodeung-daero Gwangsan-gu Gwangju, 506-711
Republic of Korea
(72) Name(s) of Designer(s): **Jong-Seo Lee and Hyung-Ju Seo**
(45) Registration Date: **26 August 2015**
(56) Related Art Documents: **Not Applicable**
(57) Statement of Newness and Distinctiveness: **Newness and distinctiveness resides in the visual features of shape and configuration and/or pattern and ornamentation of the tread pattern of a tire as shown in the accompanying representations.**

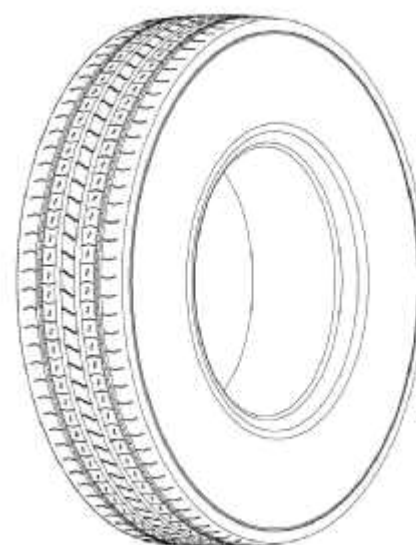

- (21) Design Number: **14189/2015**
(22) Date of Filing Application: **14 August 2015**
(24) Date from which industrial property rights may have effect: **02 June 2015**
(54) Product in respect of which the design is registered: **Trocar**
(51) International Design Classification: **24-02**
(74) Name(s) of Attorney(s): **PHILLIPS ORMONDE FITZPATRICK**
(71) Name(s) and Address(s) of Applicant(s):
Guangzhou T.K. Medical Instrument Co., Ltd.
A601 Guangzhou International Business Incubator Guangzhou Science
Park 510663 Guangzhou China
(72) Name(s) of Designer(s): **Xing Zhou and Shaoming Zhu and Linhai Liu and**
Jiajiang Wei and Huaping Xu and Lifei LUO
(45) Registration Date: **26 August 2015**
(30) Convention priority data:
(31) Number (32) Date (33) Country
201430493411.X 02 Dec 2014 CHINA
(62) Divisional of: **363816**
(56) Related Art Documents: **Not Applicable**
(57) Statement of Newness and Distinctiveness: **Those features of the trocar depicted in the representations that are new and distinctive are the shape and/or configuration. The feature shown in broken lines is not part of the design and is to be disregarded when considering the overall impression of the design.**



(21) Design Number: **14200/2015**

(22) Date of Filing Application: **17 August 2015**

(24) Date from which industrial property rights may have effect: **17 August 2015**

(54) Product in respect of which the design is registered: **Bottle cap**

(51) International Design Classification: **09-07C**

(74) Name(s) of Attorney(s): **Spruson & Ferguson**

(71) Name(s) and Address(s) of Applicant(s):

Henkel AG & Co. KGaA
Henkelstrasse 67 Dusseldorf 40589 Germany

(72) Name(s) of Designer(s): **Volker Kolsche and Richard Christopher Hagee and Katja Gerhards**

(45) Registration Date: **26 August 2015**

(30) Convention priority data:

(31) Number	(32) Date	(33) Country
002635516	17 Feb 2015	OFFICE FOR HARMONISATION IN THE INTERNAL MARKET (OHIM)

(56) Related Art Documents: **Not Applicable**

(57) Statement of Newness and Distinctiveness: **Newness and distinctiveness is claimed in the features of shape and/or configuration of a bottle cap as illustrated in the accompanying representations.**



(21) Design Number: **14201/2015**

(22) Date of Filing Application: **17 August 2015**

(24) Date from which industrial property rights may have effect: **17 August 2015**

(54) Product in respect of which the design is registered: **Bottle**

(51) International Design Classification: **09-01NES**

(74) Name(s) of Attorney(s): **Spruson & Ferguson**

(71) Name(s) and Address(s) of Applicant(s):

Henkel AG & Co. KGaA
Henkelstrasse 67 Dusseldorf 40589 Germany

(72) Name(s) of Designer(s): **Volker Kolsche and Richard Christopher Hagee and Katja Gerhards**

(45) Registration Date: **26 August 2015**

(30) Convention priority data:

(31) Number	(32) Date	(33) Country
002635516	17 Feb 2015	OFFICE FOR HARMONISATION IN THE INTERNAL MARKET (OHIM)

(56) Related Art Documents: **Not Applicable**

(57) Statement of Newness and Distinctiveness: **Newness and distinctiveness is claimed in the features of shape and/or configuration of a bottle as illustrated in the accompanying representations.**

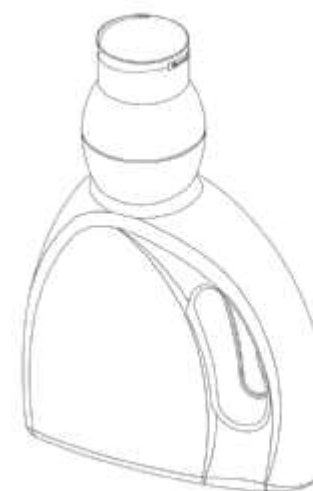

(21) Design Number: **14202/2015**

(22) Date of Filing Application: **17 August 2015**

(24) Date from which industrial property rights may have effect: **17 August 2015**

(54) Product in respect of which the design is registered: **Bottle**

(51) International Design Classification: **09-01NES**

(74) Name(s) of Attorney(s): **Spruson & Ferguson**

(71) Name(s) and Address(s) of Applicant(s):

Henkel AG & Co. KGaA
Henkelstrasse 67 Dusseldorf 40589 Germany

(72) Name(s) of Designer(s): **Volker Kolsche and Richard Christopher Hagee and Katja Gerhards**

(45) Registration Date: **26 August 2015**

(30) Convention priority data:

(31) Number	(32) Date	(33) Country
002635516	17 Feb 2015	OFFICE FOR HARMONISATION IN THE INTERNAL MARKET (OHIM)

(56) Related Art Documents: **Not Applicable**

(57) Statement of Newness and Distinctiveness: **Newness and distinctiveness is claimed in the features of shape and/or configuration of a bottle as illustrated in the accompanying representations.**



(21) Design Number: **14203/2015**

(22) Date of Filing Application: **17 August 2015**

(24) Date from which industrial property rights may have effect: **17 August 2015**

(54) Product in respect of which the design is registered: **Bottle**

(51) International Design Classification: **09-01NES**

(74) Name(s) of Attorney(s): **Spruson & Ferguson**

(71) Name(s) and Address(s) of Applicant(s):

Henkel AG & Co. KGaA
Henkelstrasse 67 Dusseldorf 40589 Germany

(72) Name(s) of Designer(s): **Volker Kolche and Richard Christopher Hagee and Katja Gerhards**

(45) Registration Date: **26 August 2015**

(30) Convention priority data:

(31) Number	(32) Date	(33) Country
002635516	17 Feb 2015	OFFICE FOR HARMONISATION IN THE INTERNAL MARKET (OHIM)

(56) Related Art Documents: **Not Applicable**

(57) Statement of Newness and Distinctiveness: **Newness and distinctiveness is claimed in the features of shape and/or configuration of a bottle as illustrated in the accompanying representations.**



(21) Design Number: **14204/2015**
(22) Date of Filing Application: **17 August 2015**
(24) Date from which industrial property rights may have effect: **17 August 2015**
(54) Product in respect of which the design is registered: **Garnishment for motor vehicle**
(51) International Design Classification: **12-16B**
(74) Name(s) of Attorney(s): **Spruson & Ferguson**
(71) Name(s) and Address(s) of Applicant(s):
Mazda Motor Corporation
3-1, Shinchi, Fuchu-cho, Aki-gun, Hiroshima Japan
(72) Name(s) of Designer(s): **Shigeki Nakamura and Keisuke Watanabe and Yukio Irie and Heitetsu Takemoto**
(45) Registration Date: **26 August 2015**
(30) Convention priority data:
(31) Number (32) Date (33) Country
201530047496.3 16 Feb 2015 CHINA
(56) Related Art Documents: **Not Applicable**
(57) Statement of Newness and Distinctiveness: **Newness and distinctiveness is claimed in the features of shape and/or configuration of a garnishment for motor vehicle as illustrated in the accompanying representations.**



(21) Design Number: **14207/2015**
(22) Date of Filing Application: **17 August 2015**
(24) Date from which industrial property rights may have effect: **17 August 2015**
(54) Product in respect of which the design is registered: **A travel mug**
(51) International Design Classification: **07-01D**
(74) Name(s) of Attorney(s): **Banki Haddock Fiora**
(71) Name(s) and Address(s) of Applicant(s):
Pi-Design AG
Kantonsstrasse 100 Triengen CH-6234 Switzerland
(72) Name(s) of Designer(s): **Jorgen Bodum**
(45) Registration Date: **26 August 2015**
(30) Convention priority data:
(31) Number (32) Date (33) Country
DM/085 936 19 Mar 2015 WORLD INTELLECTUAL PROPERTY ORGANIZATION (WIPO)
(56) Related Art Documents: **Not Applicable**
(57) Statement of Newness and Distinctiveness: **The visual features of the travel mug depicted in the representations that are new and distinctive are the shape and/or configuration.**



(21) Design Number: **14208/2015**
(22) Date of Filing Application: **17 August 2015**
(24) Date from which industrial property rights may have effect: **17 August 2015**
(54) Product in respect of which the design is registered: **A travel mug**
(51) International Design Classification: **07-01D**
(74) Name(s) of Attorney(s): **Banki Haddock Fiora**
(71) Name(s) and Address(s) of Applicant(s):

Pi-Design AG
Kantonsstrasse 100 Triengen CH-6234 Switzerland

(72) Name(s) of Designer(s): **Jorgen Bodum**

(45) Registration Date: **26 August 2015**

(30) Convention priority data:

(31) Number	(32) Date	(33) Country
DM/085 936	19 Mar 2015	WORLD INTELLECTUAL PROPERTY ORGANIZATION (WIPO)

(56) Related Art Documents: **Not Applicable**

(57) Statement of Newness and Distinctiveness: **The visual features of the travel mug depicted in the representations that are new and distinctive are the shape and/or configuration.**



(21) Design Number: **14209/2015**
(22) Date of Filing Application: **17 August 2015**
(24) Date from which industrial property rights may have effect: **17 August 2015**
(54) Product in respect of which the design is registered: **A travel mug**
(51) International Design Classification: **07-01D**
(74) Name(s) of Attorney(s): **Banki Haddock Fiora**
(71) Name(s) and Address(s) of Applicant(s):

Pi-Design AG
Kantonsstrasse 100 Triengen CH-6234 Switzerland

(72) Name(s) of Designer(s): **Jorgen Bodum**

(45) Registration Date: **26 August 2015**

(30) Convention priority data:

(31) Number	(32) Date	(33) Country
DM/085 936	19 Mar 2015	WORLD INTELLECTUAL PROPERTY ORGANIZATION (WIPO)

(56) Related Art Documents: **Not Applicable**

(57) Statement of Newness and Distinctiveness: **The visual features of the travel mug depicted in the representations that are new and distinctive are the shape and/or configuration.**



(21) Design Number: **12597/2015**
(22) Date of Filing Application: **19 May 2015**
(24) Date from which industrial property rights may have effect: **19 May 2015**
(54) Product in respect of which the design is registered: **Closure**
(51) International Design Classification: **09-07A**
(74) Name(s) of Attorney(s): **Pizzeys Patent and Trade Mark Attorneys Pty Ltd**
(71) Name(s) and Address(s) of Applicant(s):
MJN U.S. Holdings LLC
2701 Patriot Blvd., 4th Floor, Glenview, IL 60026 United States of America
(72) Name(s) of Designer(s): **Marc S. Velmer and Thomas C. Horton and Patrick E. McCallister**
(45) Registration Date: **26 August 2015**
(30) Convention priority data:
(31) Number (32) Date (33) Country
29/514,623 14 Jan 2015 UNITED STATES OF AMERICA
(56) Related Art Documents: **Not Applicable**
(57) Statement of Newness and Distinctiveness: **Nil**



(21) Design Number: **13642/2015**
(22) Date of Filing Application: **21 July 2015**
(24) Date from which industrial property rights may have effect: **21 July 2015**
(54) Product in respect of which the design is registered: **Resin block**
(51) International Design Classification: **07-05NES**
(74) Name(s) of Attorney(s): **Ashurst Australia**
(71) Name(s) and Address(s) of Applicant(s):
Liquid Supply Corp., LLC
16192 Coastal Highway Lewes Delaware, 19958 United States of America
(72) Name(s) of Designer(s): **John Thomas Kucala III**
(45) Registration Date: **26 August 2015**
(30) Convention priority data:
(31) Number (32) Date (33) Country
29518957 27 Feb 2015 UNITED STATES OF AMERICA
(56) Related Art Documents: **Not Applicable**
(57) Statement of Newness and Distinctiveness: **Nil**

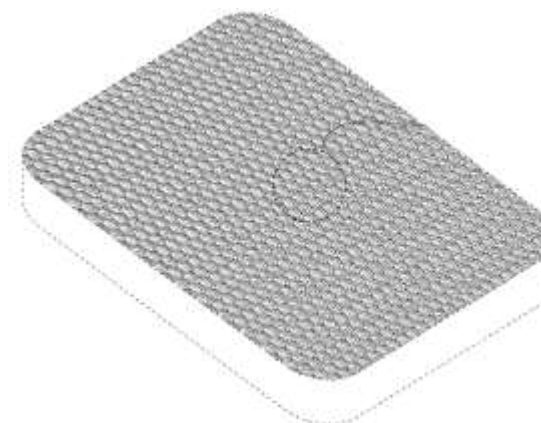

(21) Design Number: **13643/2015**
(22) Date of Filing Application: **21 July 2015**
(24) Date from which industrial property rights may have effect: **21 July 2015**
(54) Product in respect of which the design is registered: **Resin block**
(51) International Design Classification: **07-05NES**
(74) Name(s) of Attorney(s): **Ashurst Australia**
(71) Name(s) and Address(s) of Applicant(s):
Liquid Supply Corp., LLC
16192 Coastal Highway Lewes Delaware, 19958 United States of America
(72) Name(s) of Designer(s): **John Thomas Kucala III**
(45) Registration Date: **26 August 2015**
(30) Convention priority data:
(31) Number (32) Date (33) Country
29515311 21 Jan 2015 UNITED STATES OF AMERICA
(56) Related Art Documents: **Not Applicable**
(57) Statement of Newness and Distinctiveness: **Nil**

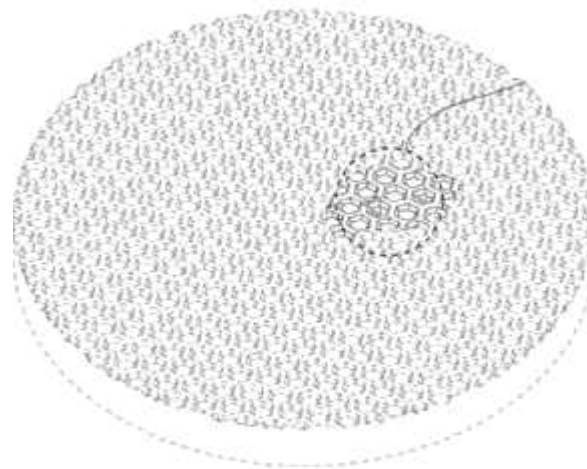

(21) Design Number: **14205/2015**
(22) Date of Filing Application: **17 August 2015**
(24) Date from which industrial property rights may have effect: **17 August 2015**
(54) Product in respect of which the design is registered: **Garnishment for motor vehicle**
(51) International Design Classification: **12-16B**
(74) Name(s) of Attorney(s): **Spruson & Ferguson**
(71) Name(s) and Address(s) of Applicant(s):
Mazda Motor Corporation
3-1, Shinchi, Fuchu-cho, Aki-gun, Hiroshima Japan
(72) Name(s) of Designer(s): **Shigeki Nakamura and Keisuke Watanabe and Yukio Irie and Heitetsu Takemoto**
(45) Registration Date: **26 August 2015**
(30) Convention priority data:
(31) Number (32) Date (33) Country
201530047496.3 16 Feb 2015 CHINA
(56) Related Art Documents: **Not Applicable**
(57) Statement of Newness and Distinctiveness: **Newness and distinctiveness is claimed in the features of shape and/or configuration of a garnishment for motor vehicle as illustrated in the accompanying representations.**



(21) Design Number: **14238/2015**

(22) Date of Filing Application: **18 August 2015**

(24) Date from which industrial property rights may have effect: **18 August 2015**

(54) Product in respect of which the design is registered: **Clip for clothes**

(51) International Design Classification: **07-05A, 08-08NES**

(74) Name(s) of Attorney(s): **Lord & Company**

(71) Name(s) and Address(s) of Applicant(s):

**ICS Investments S.a r.l.
5 rue du Saint Exprit L-1475 Luxembourg**

(72) Name(s) of Designer(s): **Lionel Fantauzzo**

(45) Registration Date: **26 August 2015**

(30) Convention priority data:

(31) Number	(32) Date	(33) Country
WIPO42003	18 Feb 2015	OFFICE FOR HARMONISATION IN THE INTERNAL MARKET (OHIM)

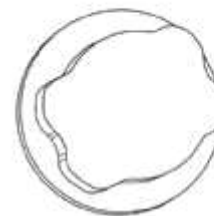

(56) Related Art Documents: **Not Applicable**

(57) Statement of Newness and Distinctiveness: **Nil**

(21) Design Number: **14239/2015**

(22) Date of Filing Application: **18 August 2015**

(24) Date from which industrial property rights may have effect: **18 August 2015**

(54) Product in respect of which the design is registered: **Fastening device**

(51) International Design Classification: **08-08A**

(74) Name(s) of Attorney(s): **PHILLIPS ORMONDE FITZPATRICK**

(71) Name(s) and Address(s) of Applicant(s):

**Concept Fasteners Pty Ltd
9 Flight Dr Tullamarine VIC 3043 Australia**

(72) Name(s) of Designer(s): **Mario Micallef**

(45) Registration Date: **26 August 2015**

(56) Related Art Documents: **Not Applicable**

(57) Statement of Newness and Distinctiveness: **Those features of the fastening device depicted in the representations that are new and distinctive are the shape and/or configuration. The feature shown in broken line is not part of the design and is to be disregarded when considering the overall impression of the design.**

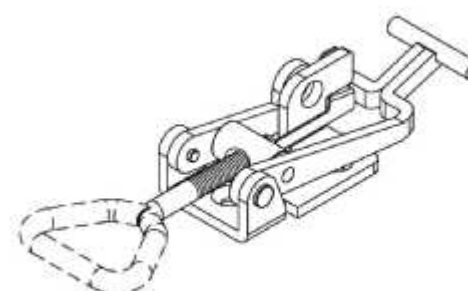

(21) Design Number: **14241/2015**

(22) Date of Filing Application: **18 August 2015**

(24) Date from which industrial property rights may have effect: **18 August 2015**

(54) Product in respect of which the design is registered: **Blender base**

(51) International Design Classification: **31-00**

(74) Name(s) of Attorney(s): **Griffith Hack**

(71) Name(s) and Address(s) of Applicant(s):

KENWOOD LIMITED

**1 Kenwood Business Park New Lane Havant Hampshire, PO9 2NH
United Kingdom**

(72) Name(s) of Designer(s): **Sam Davies**

(45) Registration Date: **26 August 2015**

(30) Convention priority data:

(31) Number
001430706

(32) Date
19 Feb 2015

(33) Country
**OFFICE FOR HARMONISATION IN
THE INTERNAL MARKET (OHIM)**

(56) Related Art Documents: **Not Applicable**

(57) Statement of Newness and Distinctiveness: **Newness and distinctiveness resides in the visual features, including shape and configuration, of a Blender Base as shown in solid outline in the accompanying drawings. When determining whether the design is substantially similar in overall impression to another design, no particular regard is to be had to those features shown in dotted outline in the accompanying drawings, which features are provided for illustrative purposes only.**



(21) Design Number: **14242/2015**

(22) Date of Filing Application: **18 August 2015**

(24) Date from which industrial property rights may have effect: **18 August 2015**

(54) Product in respect of which the design is registered: **Blender base**

(51) International Design Classification: **31-00**

(74) Name(s) of Attorney(s): **Griffith Hack**

(71) Name(s) and Address(s) of Applicant(s):

KENWOOD LIMITED

**1 Kenwood Business Park New Lane Havant Hampshire, PO9 2NH
United Kingdom**

(72) Name(s) of Designer(s): **Sam Davies**

(45) Registration Date: **26 August 2015**

(30) Convention priority data:

(31) Number
001430706

(32) Date
19 Feb 2015

(33) Country
**OFFICE FOR HARMONISATION IN
THE INTERNAL MARKET (OHIM)**

(56) Related Art Documents: **Not Applicable**

(57) Statement of Newness and Distinctiveness: **Newness and distinctiveness resides in the visual features, including shape and configuration, of a Blender Base as shown in solid outline in the accompanying drawings. When determining whether the design is substantially similar in overall impression to another design, no particular regard is to be had to those features shown in dotted outline in the accompanying drawings, which features are provided for illustrative purposes only.**



(21) Design Number: **14244/2015**
(22) Date of Filing Application: **18 August 2015**
(24) Date from which industrial property rights may have effect: **18 August 2015**
(54) Product in respect of which the design is registered: **A weight**
(51) International Design Classification: **10-04**
(74) Name(s) of Attorney(s): **EAGAR & MARTIN PTY LTD**
(71) Name(s) and Address(s) of Applicant(s):
Liberation Developments Pty Ltd
L1 172 Evans Rd Salisbury QLD 4107 Australia
(72) Name(s) of Designer(s): **Gregory James Bloom**
(45) Registration Date: **26 August 2015**
(56) Related Art Documents: **Not Applicable**
(57) Statement of Newness and Distinctiveness: **Nil**



(21) Design Number: **14247/2015**
(22) Date of Filing Application: **19 August 2015**
(24) Date from which industrial property rights may have effect: **19 August 2015**
(54) Product in respect of which the design is registered: **Pump**
(51) International Design Classification: **15-02**
(74) Name(s) of Attorney(s): **Duncan Cotterill Lawyers**
(71) Name(s) and Address(s) of Applicant(s):
Huntleigh Technology Limited
Arjohuntleigh House Houghton Hall Business Park Dunstable,
Bedfordshire LU5 5XF United Kingdom
(72) Name(s) of Designer(s): **Julia Acosta and Bruce McNeil and Kenneth Mitchel Knowles and X.Lu Zheng and Clive Goodfield and Robert Hibberdine and Urban Orrell**
(45) Registration Date: **26 August 2015**
(30) Convention priority data:
(31) Number (32) Date (33) Country
29518106 19 Feb 2015 UNITED STATES OF AMERICA
(56) Related Art Documents: **Not Applicable**
(57) Statement of Newness and Distinctiveness: **The newness and distinctiveness of the design resides in the shape and/or configuration of a pump as shown in the accompanying representations. The broken lines are not part of the design and are to be disregarded when considering the overall impression of the design.**

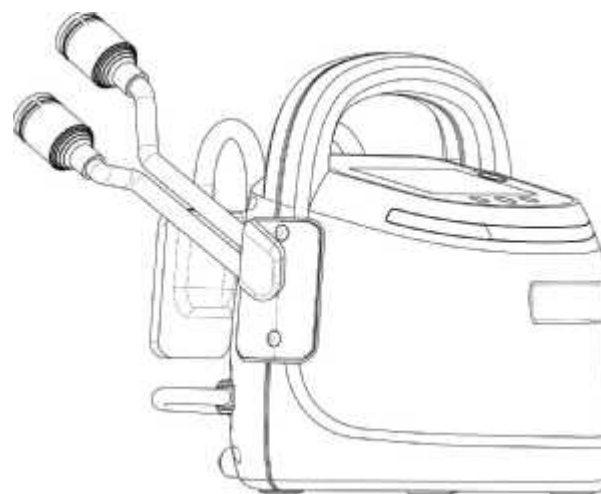

- (21) Design Number: **14248/2015**
(22) Date of Filing Application: **19 August 2015**
(24) Date from which industrial property rights may have effect: **19 August 2015**
(54) Product in respect of which the design is registered: **Hook for a boat**
(51) International Design Classification: **08-08NES**
(74) Name(s) of Attorney(s):
(71) Name(s) and Address(s) of Applicant(s):
John Robert Pomper
46 Cove Bvd River Heads QLD 4655 Australia
(72) Name(s) of Designer(s): **John Robert Pomper**
(45) Registration Date: **26 August 2015**
(56) Related Art Documents: **Not Applicable**
(57) Statement of Newness and Distinctiveness: **The newness and distinctiveness of the design resides in the shape and/or configuration of the HOOK FOR A BOAT as shown in the representations.**



- (21) Design Number: **14249/2015**
(22) Date of Filing Application: **19 August 2015**
(24) Date from which industrial property rights may have effect: **19 August 2015**
(54) Product in respect of which the design is registered: **A front bumper for an automobile**
(51) International Design Classification: **12-16C**
(74) Name(s) of Attorney(s): **Spruson & Ferguson**
(71) Name(s) and Address(s) of Applicant(s):
Honda Motor Co., Ltd.
1-1, Minami-Aoyama 2-Chome, Minato-ku Tokyo Japan
(72) Name(s) of Designer(s): **Noriyuki Ishii**
(45) Registration Date: **26 August 2015**
(30) Convention priority data:
(31) Number (32) Date (33) Country
2015-003478 20 Feb 2015 JAPAN
(56) Related Art Documents: **Not Applicable**
(57) Statement of Newness and Distinctiveness: **Newness and distinctiveness is claimed in the features of shape and/or configuration of a front bumper for an automobile as illustrated in the accompanying representations.**



(21) Design Number: **14251/2015**
(22) Date of Filing Application: **19 August 2015**
(24) Date from which industrial property rights may have effect: **19 August 2015**
(54) Product in respect of which the design is registered: **A grill for an automobile**
(51) International Design Classification: **12-16B**
(74) Name(s) of Attorney(s): **Spruson & Ferguson**
(71) Name(s) and Address(s) of Applicant(s):
Honda Motor Co., Ltd.
1-1, Minami-Aoyama 2-Chome, Minato-ku Tokyo Japan
(72) Name(s) of Designer(s): **Noriyuki Ishii**
(45) Registration Date: **26 August 2015**
(30) Convention priority data:
(31) Number (32) Date (33) Country
2015-003484 20 Feb 2015 JAPAN
(56) Related Art Documents: **Not Applicable**
(57) Statement of Newness and Distinctiveness: **Newness and distinctiveness is claimed in the features of shape and/or configuration of a grill for an automobile as illustrated in the accompanying representations.**



(21) Design Number: **14253/2015**
(22) Date of Filing Application: **19 August 2015**
(24) Date from which industrial property rights may have effect: **19 August 2015**
(54) Product in respect of which the design is registered: **A front combination lamp for an automobile**
(51) International Design Classification: **26-06**
(74) Name(s) of Attorney(s): **Spruson & Ferguson**
(71) Name(s) and Address(s) of Applicant(s):
Honda Motor Co., Ltd.
1-1, Minami-Aoyama 2-chome, Minato-ku, Tokyo Japan
(72) Name(s) of Designer(s): **Tetsuji Morikawa**
(45) Registration Date: **27 August 2015**
(30) Convention priority data:
(31) Number (32) Date (33) Country
2015-003487 20 Feb 2015 JAPAN
(56) Related Art Documents: **Not Applicable**
(57) Statement of Newness and Distinctiveness: **Newness and distinctiveness is claimed in the features of shape and/or configuration of a front combination lamp for an automobile as illustrated in the accompanying representations.**



- (21) Design Number: **14254/2015**
(22) Date of Filing Application: **19 August 2015**
(24) Date from which industrial property rights may have effect: **19 August 2015**
(54) Product in respect of which the design is registered: **A front combination lamp for an automobile**
(51) International Design Classification: **26-06**
(74) Name(s) of Attorney(s): **Spruson & Ferguson**
(71) Name(s) and Address(s) of Applicant(s):
Honda Motor Co., Ltd.
1-1, Minami-Aoyama 2-Chome, Minato-ku Tokyo Japan
(72) Name(s) of Designer(s): **Noriyuki Ishii**
(45) Registration Date: **27 August 2015**
(30) Convention priority data:
(31) Number (32) Date (33) Country
2015-003488 20 Feb 2015 JAPAN
(56) Related Art Documents: **Not Applicable**
(57) Statement of Newness and Distinctiveness: **Newness and distinctiveness is claimed in the features of shape and/or configuration of a front combination lamp for an automobile as illustrated in the accompanying representations.**



- (21) Design Number: **14255/2015**
(22) Date of Filing Application: **19 August 2015**
(24) Date from which industrial property rights may have effect: **19 August 2015**
(54) Product in respect of which the design is registered: **A rear combination lamp for an automobile**
(51) International Design Classification: **26-06**
(74) Name(s) of Attorney(s): **Spruson & Ferguson**
(71) Name(s) and Address(s) of Applicant(s):
Honda Motor Co., Ltd.
1-1, Minami-Aoyama 2-Chome, Minato-ku Tokyo Japan
(72) Name(s) of Designer(s): **Hoiyoung Choi**
(45) Registration Date: **27 August 2015**
(30) Convention priority data:
(31) Number (32) Date (33) Country
2015-003490 20 Feb 2015 JAPAN
(56) Related Art Documents: **Not Applicable**
(57) Statement of Newness and Distinctiveness: **Newness and distinctiveness is claimed in the features of shape and/or configuration of a rear combination lamp for an automobile as illustrated in the accompanying representations.**



- (21) Design Number: **14258/2015**
(22) Date of Filing Application: **19 August 2015**
(24) Date from which industrial property rights may have effect: **19 August 2015**
(54) Product in respect of which the design is registered: **Toner cartridge**
(51) International Design Classification: **14-02**
(74) Name(s) of Attorney(s): **Shelston IP**
(71) Name(s) and Address(s) of Applicant(s):
Fuji Xerox Co., Ltd.
7-3, Akasaka 9-chome Minato-ku Tokyo 107-0052 Japan
(72) Name(s) of Designer(s): **Yuki Terakado and Takuji Matsumoto**
(45) Registration Date: **27 August 2015**
(56) Related Art Documents: **Not Applicable**
(57) Statement of Newness and Distinctiveness: **Newness and distinctiveness reside in the features of shape and/or configuration of the Toner Cartridge as shown in solid lines in the accompanying representations. The gray scale shading in each of the figures is shading which merely shows the three-dimensional surface of the Toner Cartridge and colour per se is not a visual feature of the design.**



- (21) Design Number: **14259/2015**
(22) Date of Filing Application: **19 August 2015**
(24) Date from which industrial property rights may have effect: **19 August 2015**
(54) Product in respect of which the design is registered: **Stimulation device**
(51) International Design Classification: **28-03NES**
(74) Name(s) of Attorney(s): **FB Rice**
(71) Name(s) and Address(s) of Applicant(s):
REDSCHLAG HOLDING GmbH
Rudolf-Diesel-Weg 10 Hannover 30419 Germany
(72) Name(s) of Designer(s): **Ignacio Nolasco**
(45) Registration Date: **27 August 2015**
(30) Convention priority data:
(31) Number (32) Date (33) Country
002711135-0002 01 Jun 2015 OFFICE FOR HARMONISATION IN THE INTERNAL MARKET (OHIM)
(56) Related Art Documents: **Not Applicable**
(57) Statement of Newness and Distinctiveness: **Newness and distinctiveness reside in the features of shape and configuration of the design as shown in the representations.**



(21) Design Number: **14147/2015**

(22) Date of Filing Application: **13 August 2015**

(24) Date from which industrial property rights may have effect: **13 August 2015**

(54) Product in respect of which the design is registered: **Ore screening panel**

(51) International Design Classification: **15-99**

(74) Name(s) of Attorney(s):

(71) Name(s) and Address(s) of Applicant(s):

RCM PLASTICS CC

Corner Main and Dam Roads Anderbolt, Boksburg, 1459 South Africa

(72) Name(s) of Designer(s): **Johan Theodore Reid-Robertson and Angelo Marietta**

(45) Registration Date: **27 August 2015**

(56) Related Art Documents: **Not Applicable**

(57) Statement of Newness and Distinctiveness: **Newness and distinctiveness is claimed in the features of shape and/or configuration of the screening panel including the apertures as illustrated in the accompanying representations. The length and width of the panel are variable.**

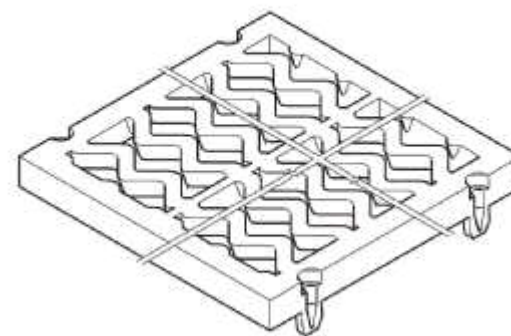

(21) Design Number: **14256/2015**

(22) Date of Filing Application: **19 August 2015**

(24) Date from which industrial property rights may have effect: **19 August 2015**

(54) Product in respect of which the design is registered: **Shower screen frame**

(51) International Design Classification: **25-01K**

(74) Name(s) of Attorney(s):

(71) Name(s) and Address(s) of Applicant(s):

ALUMINIUM INDUSTRIES OF AUSTRALIA PTY. LTD.

160 Ordish Rd Dandenong South VIC, 3175 Australia

(72) Name(s) of Designer(s): **Lee Brown**

(45) Registration Date: **27 August 2015**

(56) Related Art Documents: **Not Applicable**

(57) Statement of Newness and Distinctiveness: **Newness and Distinctiveness is claimed in the shape and/or configuration of the extrusion profile of indefinite length as illustrated in the representations.**

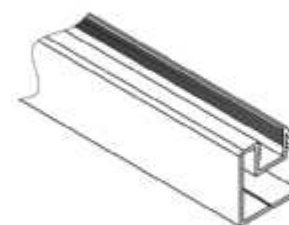

- (21) Design Number: **14257/2015**
(22) Date of Filing Application: **19 August 2015**
(24) Date from which industrial property rights may have effect: **19 August 2015**
(54) Product in respect of which the design is registered: **Shower screen frame**
(51) International Design Classification: **25-01K**
(74) Name(s) of Attorney(s):
(71) Name(s) and Address(s) of Applicant(s):
ALUMINIUM INDUSTRIES OF AUSTRALIA PTY. LTD.
160 Ordish Rd Dandenong South VIC, 3175 Australia
(72) Name(s) of Designer(s): **Lee Brown**
(45) Registration Date: **27 August 2015**
(56) Related Art Documents: **Not Applicable**
(57) Statement of Newness and Distinctiveness: **Newness and Distinctiveness is claimed in the shape and/or configuration of the extrusion profile of indefinite length as illustrated in the representations.**

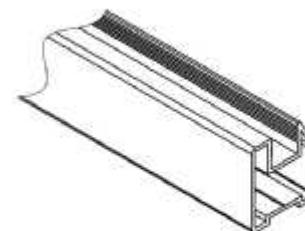

- (21) Design Number: **14263/2015**
(22) Date of Filing Application: **19 August 2015**
(24) Date from which industrial property rights may have effect: **19 August 2015**
(54) Product in respect of which the design is registered: **Base of bacon cooker**
(51) International Design Classification: **07-02C, 07-02NES**
(74) Name(s) of Attorney(s): **Callinans**
(71) Name(s) and Address(s) of Applicant(s):
The Decor Corporation Pty. Ltd.
1314 Ferntree Gully Road Scoresby VIC 3179
(72) Name(s) of Designer(s): **Jim Samartgis**
(45) Registration Date: **27 August 2015**
(56) Related Art Documents: **Not Applicable**
(57) Statement of Newness and Distinctiveness: **Nil**

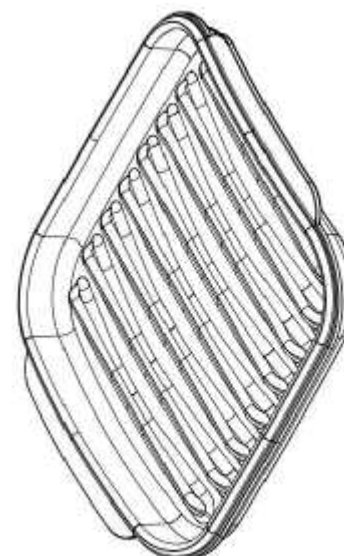

(21) Design Number: **14264/2015**
(22) Date of Filing Application: **19 August 2015**
(24) Date from which industrial property rights may have effect: **19 August 2015**
(54) Product in respect of which the design is registered: **Lid of bacon cooker**
(51) International Design Classification: **07-02NES**
(74) Name(s) of Attorney(s): **Callinans**
(71) Name(s) and Address(s) of Applicant(s):
The Decor Corporation Pty. Ltd.
1314 Ferntree Gully Rd Scoresby VIC 3179 Australia
(72) Name(s) of Designer(s): **Jim Samartgis**
(45) Registration Date: **27 August 2015**
(56) Related Art Documents: **Not Applicable**
(57) Statement of Newness and Distinctiveness: **Nil**

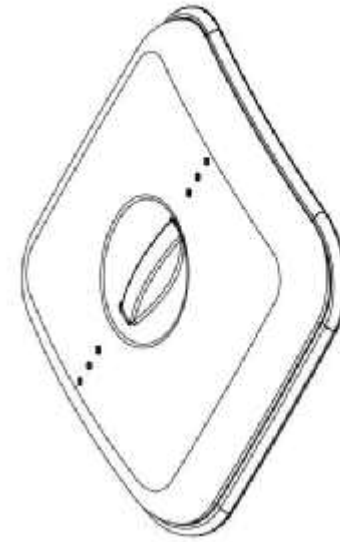

(21) Design Number: **14265/2015**
(22) Date of Filing Application: **19 August 2015**
(24) Date from which industrial property rights may have effect: **19 August 2015**
(54) Product in respect of which the design is registered: **Chair control mechanism**
(51) International Design Classification: **06-01NES, 06-06G**
(74) Name(s) of Attorney(s): **Collison & Co**
(71) Name(s) and Address(s) of Applicant(s):
Office Portfolio Pty Ltd
34b Edgcumbe Tce Rosslyn Park SA 5072 Australia
(72) Name(s) of Designer(s): **Justin Brown**
(45) Registration Date: **27 August 2015**
(56) Related Art Documents: **Not Applicable**
(57) Statement of Newness and Distinctiveness: **Nil**

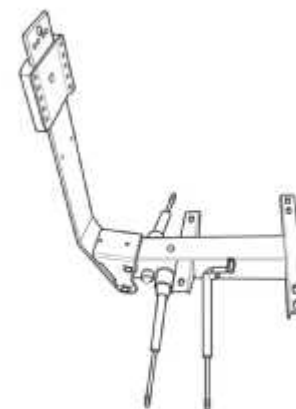

(21) Design Number: **14269/2015**
(22) Date of Filing Application: **20 August 2015**
(24) Date from which industrial property rights may have effect: **20 August 2015**
(54) Product in respect of which the design is registered: **A pergola truss**
(51) International Design Classification: **25-01B**
(74) Name(s) of Attorney(s):
(71) Name(s) and Address(s) of Applicant(s):
Design Construct Industries Pty Ltd
C/- Patentec Patent Attorneys PO Box A1172 Sydney South NSW 1235
Australia
(72) Name(s) of Designer(s): **Andy Stodulka**
(45) Registration Date: **27 August 2015**
(56) Related Art Documents: **Not Applicable**
(57) Statement of Newness and Distinctiveness: **Nil**

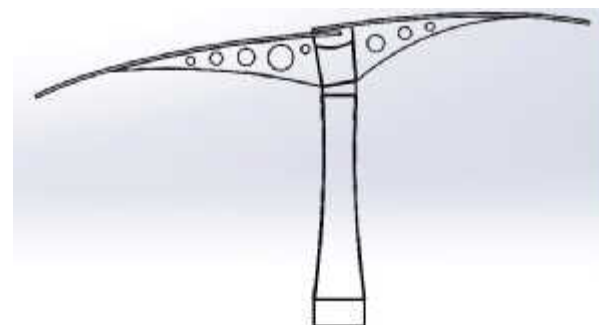

(21) Design Number: **12717/2015**
(22) Date of Filing Application: **27 May 2015**
(24) Date from which industrial property rights may have effect: **27 May 2015**
(54) Product in respect of which the design is registered: **Entrance for theatre building**
(51) International Design Classification: **25-03**
(74) Name(s) of Attorney(s): **IP Gateway Patent & Trade Mark Attorneys Pty Ltd**
(71) Name(s) and Address(s) of Applicant(s):
Dolby Laboratories Licensing Corporation
100 Potrero Avenue San Francisco CA 94103-4813 United States of America
(72) Name(s) of Designer(s): **Wilhem Oehl and Mark Little and David Herman and Vincent Voron**
(45) Registration Date: **27 August 2015**
(30) Convention priority data:
(31) Number (32) Date (33) Country
201430180789.6 28 Nov 2014 CHINA
(56) Related Art Documents: **Not Applicable**
(57) Statement of Newness and Distinctiveness: **Newness and distinctiveness resides in the shape and configuration of a theatre entrance as shown in the accompanying representations.**

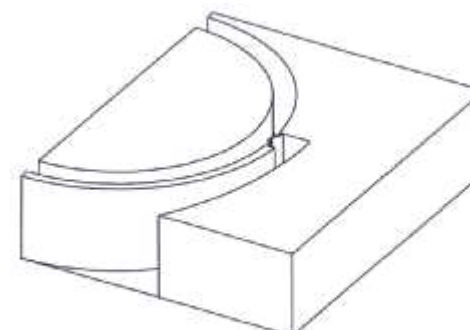

(21) Design Number: **12718/2015**
(22) Date of Filing Application: **27 May 2015**
(24) Date from which industrial property rights may have effect: **27 May 2015**
(54) Product in respect of which the design is registered: **Entrance for theatre building**
(51) International Design Classification: **25-03**
(74) Name(s) of Attorney(s): **IP Gateway Patent & Trade Mark Attorneys Pty Ltd**
(71) Name(s) and Address(s) of Applicant(s):
Dolby Laboratories Licensing Corporation
100 Potrero Avenue San Francisco CA 94103-4813 United States of America
(72) Name(s) of Designer(s): **Wilhem Oehl and Mark Little and David Herman and Vincent Voron**
(45) Registration Date: **27 August 2015**
(30) Convention priority data:
(31) Number (32) Date (33) Country
201430480975.X 28 Nov 2014 CHINA
(56) Related Art Documents: **Not Applicable**
(57) Statement of Newness and Distinctiveness: **Newness and distinctiveness reside in the shape and configuration of a theatre entrance as shown in the accompanying representations.**

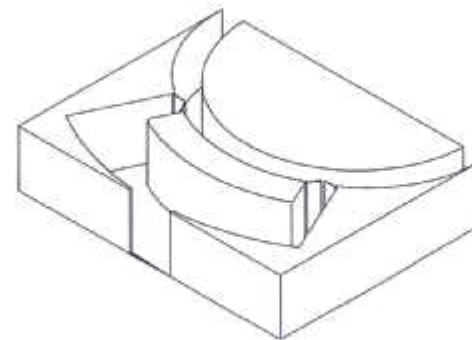

(21) Design Number: **12075/2015**
(22) Date of Filing Application: **20 April 2015**
(24) Date from which industrial property rights may have effect: **20 April 2015**
(54) Product in respect of which the design is registered: **Pool cleaner**
(51) International Design Classification: **08-05A**
(74) Name(s) of Attorney(s): **Davies Collison Cave**
(71) Name(s) and Address(s) of Applicant(s):
Hayward Industries, Inc.
620 Division Street Elizabeth New Jersey 07201 United States of America
(72) Name(s) of Designer(s): **Patrick Mainville**
(45) Registration Date: **27 August 2015**
(30) Convention priority data:
(31) Number (32) Date (33) Country
29/508,554 17 Nov 2014 UNITED STATES OF AMERICA
(56) Related Art Documents: **Not Applicable**
(57) Statement of Newness and Distinctiveness: **Nil**



(21) Design Number: **14211/2015**
(22) Date of Filing Application: **17 August 2015**
(24) Date from which industrial property rights may have effect: **17 August 2015**
(54) Product in respect of which the design is registered: **Trouser**
(51) International Design Classification: **02-02C**
(74) Name(s) of Attorney(s):
(71) Name(s) and Address(s) of Applicant(s):

Benjamin David Tiver
35 Koongarra Ave Magill SA 5072 Australia

(72) Name(s) of Designer(s): **Benjamin David Tiver**

(45) Registration Date: **27 August 2015**

(56) Related Art Documents: **Not Applicable**

(57) Statement of Newness and Distinctiveness: **This trouser design is new because the panels of each leg are in a rectangular box shape having 4 sides, constructed of 4 panels, joined by 4 side seams (being 2 inner & 2 outer), the combination of which fit around each of the wearer's legs in a distinctive 3 dimensional box shaped design. There are front and back panels to the trousers. These are joined by an inner-leg gusset panel going the whole length of the leg, as well as outside-leg panels which also go the whole length of the leg from hem to yoke. This panel combination causes a distinctive 3 dimensional, 4 sided shaped design feature for each leg, which is recognizable by the 2 inside and 2 outside side seams. As opposed to previous trouser designs which are constructed from front and rear panels joined by 2 side seams per leg (being inner and outer), which fit around the wearer in an envelope design and 2 dimensional manner. Nothing new or distinct is claimed in the design relating to pockets, hems, yoke, waist band, zipper.**

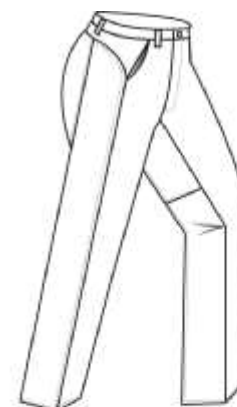

(21) Design Number: **14212/2015**
(22) Date of Filing Application: **17 August 2015**
(24) Date from which industrial property rights may have effect: **17 August 2015**
(54) Product in respect of which the design is registered: **Cash register**
(51) International Design Classification: **18-01**
(74) Name(s) of Attorney(s): **Shelston IP**
(71) Name(s) and Address(s) of Applicant(s):

Zhejiang Xkeshi Network Technology Co., Ltd.
Room 204, No. 1 Building No. 18 Sanhuaili Lane Xiacheng District
Hangzhou Zhejiang China

(72) Name(s) of Designer(s): **Yongliang Zong**

(45) Registration Date: **27 August 2015**

(30) Convention priority data:

(31) Number (32) Date (33) Country
201530293319.3 06 Aug 2015 CHINA

(56) Related Art Documents: **Not Applicable**

(57) Statement of Newness and Distinctiveness: **Newness and distinctiveness reside in the features of shape and/or configuration of a CASH REGISTER as illustrated in the accompanying representations.**



- (21) Design Number: **14250/2015**
(22) Date of Filing Application: **19 August 2015**
(24) Date from which industrial property rights may have effect: **19 August 2015**
(54) Product in respect of which the design is registered: **A rear bumper for an automobile**
(51) International Design Classification: **12-16C**
(74) Name(s) of Attorney(s): **Spruson & Ferguson**
(71) Name(s) and Address(s) of Applicant(s):
Honda Motor Co., Ltd.
1-1, Minami-Aoyama 2-Chome, Minato-ku Tokyo Japan
(72) Name(s) of Designer(s): **Noriyuki Ishii**
(45) Registration Date: **27 August 2015**
(30) Convention priority data:
(31) Number (32) Date (33) Country
2015-003481 20 Feb 2015 JAPAN
(56) Related Art Documents: **Not Applicable**
(57) Statement of Newness and Distinctiveness: **Newness and distinctiveness is claimed in the features of shape and/or configuration of a rear bumper for an automobile as illustrated in the accompanying representations.**



- (21) Design Number: **14260/2015**
(22) Date of Filing Application: **19 August 2015**
(24) Date from which industrial property rights may have effect: **19 August 2015**
(54) Product in respect of which the design is registered: **Pram/ stroller**
(51) International Design Classification: **12-12**
(74) Name(s) of Attorney(s):
(71) Name(s) and Address(s) of Applicant(s):
REDSBABY PTY. LTD.
PO BOX 3033 Bellevue Hill NSW 2023 Australia
(72) Name(s) of Designer(s): **Meagan Redelman**
(45) Registration Date: **27 August 2015**
(56) Related Art Documents: **Not Applicable**
(57) Statement of Newness and Distinctiveness: **The newness and distinctiveness of the design resides in the overall shape and/or configuration of a pram/stroller as illustrated in the accompanying representations. Particular emphasis is placed on the newness and distinctiveness of the shape and configuration of the soft goods materials design (canopy, seat unit design, harness/ harness padding, carrycot apron, carrycot canopy, carrycot lining, basket design) in conjunction with the hard goods design (front and rear wheels, handlebar, chassis etc).**



- (21) Design Number: **12995/2015**
(22) Date of Filing Application: **15 June 2015**
(24) Date from which industrial property rights may have effect: **15 June 2015**
(54) Product in respect of which the design is registered: **Dock for a keyboard**
(51) International Design Classification: **14-02**
(74) Name(s) of Attorney(s): **WATERMARK PATENT AND TRADE MARKS ATTORNEYS**
(71) Name(s) and Address(s) of Applicant(s):
Bloomberg Finance L.P.
731 Lexington Avenue New York New York, 10022 United States of America
(72) Name(s) of Designer(s): **Helmars Ozolins and Avram Kaufman and Adam Goldsmith and Sean Roarty and Sigrid G Moeslinger and Masamichi Udagawa**
(45) Registration Date: **27 August 2015**
(30) Convention priority data:
(31) Number (32) Date (33) Country
29/511,911 15 Dec 2014 UNITED STATES OF AMERICA
(56) Related Art Documents: **Not Applicable**
(57) Statement of Newness and Distinctiveness: **Newness and distinctiveness resides in the features of shape and configuration of a dock for a keyboard as shown in the accompanying representations. The portions shown in broken lines are for illustrative purposes only and do not form part of the design.**

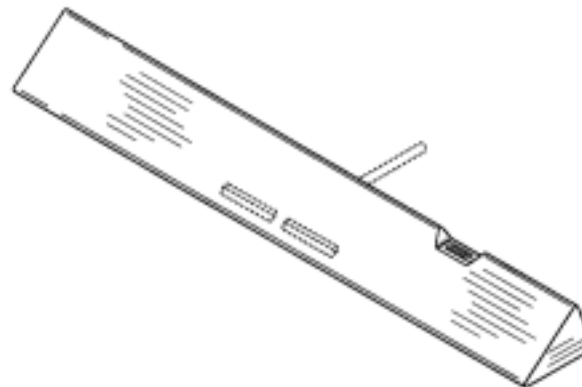

- (21) Design Number: **12997/2015**
(22) Date of Filing Application: **15 June 2015**
(24) Date from which industrial property rights may have effect: **15 June 2015**
(54) Product in respect of which the design is registered: **Keyboard and dock for a keyboard**
(51) International Design Classification: **14-02**
(74) Name(s) of Attorney(s): **WATERMARK PATENT AND TRADE MARKS ATTORNEYS**
(71) Name(s) and Address(s) of Applicant(s):
Bloomberg Finance L.P.
731 Lexington Avenue New York New York, 10022 United States of America
(72) Name(s) of Designer(s): **Avram Kaufman and Adam Goldsmith and Sean Roarty and Sigrid G Moeslinger and Masamichi Udagawa and Helmars E Ozolins**
(45) Registration Date: **27 August 2015**
(30) Convention priority data:
(31) Number (32) Date (33) Country
29/511,921 15 Dec 2014 UNITED STATES OF AMERICA
(56) Related Art Documents: **Not Applicable**
(57) Statement of Newness and Distinctiveness: **Newness and distinctiveness resides in the features of shape and configuration of a keyboard and dock for a keyboard as shown in the accompanying representations. The portions shown in broken lines are for illustrative purposes only and do not form part of the design.**

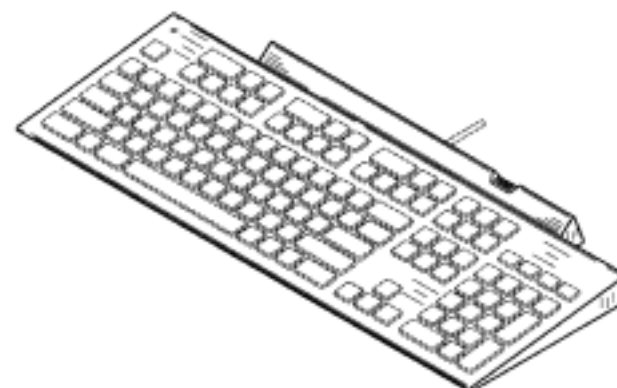

- (21) Design Number: **13193/2015**
(22) Date of Filing Application: **23 June 2015**
(24) Date from which industrial property rights may have effect: **23 June 2015**
(54) Product in respect of which the design is registered: **Mounting clip for panel wall**
(51) International Design Classification: **08-08M**
(74) Name(s) of Attorney(s): **Griffith Hack**
(71) Name(s) and Address(s) of Applicant(s):
CSR Building Products Limited
Triniti 3 39 Delhi Rd North Ryde NSW 2113 Australia
(72) Name(s) of Designer(s): **Greg Selwood**
(45) Registration Date: **27 August 2015**
(56) Related Art Documents: **Not Applicable**
(57) Statement of Newness and Distinctiveness: **Newness and distinctiveness resides in the visual features, including shape and configuration, of a MOUNTING CLIP as shown in the accompanying drawings. The features shown using dotted outline in the accompanying drawings are for illustrative purposes.**

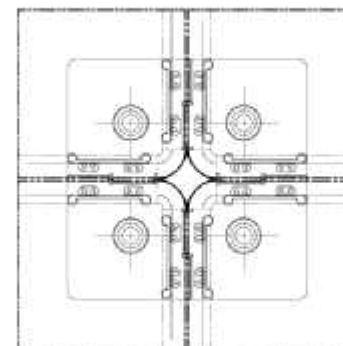

- (21) Design Number: **13271/2015**
(22) Date of Filing Application: **23 June 2015**
(24) Date from which industrial property rights may have effect: **23 June 2015**
(54) Product in respect of which the design is registered: **Hair growth device**
(51) International Design Classification: **28-03C**
(74) Name(s) of Attorney(s):
(71) Name(s) and Address(s) of Applicant(s):
Deborah Nicholls
C/- MLB Lawyers & Associates L1_441 South Rd Bentleigh VIC 3204
Australia
(72) Name(s) of Designer(s): **Deborah Nicholls**
(45) Registration Date: **27 August 2015**
(56) Related Art Documents: **Not Applicable**
(57) Statement of Newness and Distinctiveness: **Nil**



(21) Design Number: **13287/2015**
(22) Date of Filing Application: **30 June 2015**
(24) Date from which industrial property rights may have effect: **30 June 2015**
(54) Product in respect of which the design is registered: **Light Bulb**
(51) International Design Classification: **26-04**
(74) Name(s) of Attorney(s): **Pizzeys Patent and Trade Mark Attorneys Pty Ltd**
(71) Name(s) and Address(s) of Applicant(s):
Timothy Golnik
2021 26th St, Apt. 104 San Francisco CA, 94112 United States of America
Diana Chang
141 Trumbull Street San Francisco CA, 94112 United States of America
Joshua David Banko
110 Seale Ave Palo Alto CA, 94301 United States of America
(72) Name(s) of Designer(s): **Timothy Golnik and Diana Chang and Joshua David Banko**
(45) Registration Date: **27 August 2015**
(30) Convention priority data:
(31) Number (32) Date (33) Country
29/513576 02 Jan 2015 UNITED STATES OF AMERICA
(56) Related Art Documents: **Not Applicable**
(57) Statement of Newness and Distinctiveness: **Nil**

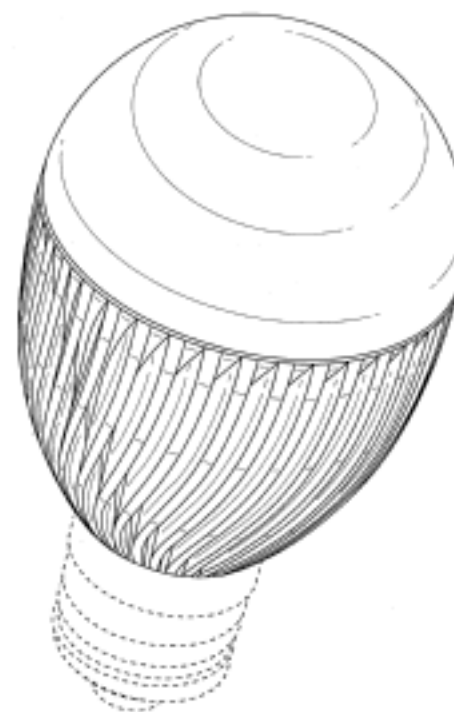

(21) Design Number: **14154/2015**
(22) Date of Filing Application: **13 August 2015**
(24) Date from which industrial property rights may have effect: **13 August 2015**
(54) Product in respect of which the design is registered: **Tracking device**
(51) International Design Classification: **14-99**
(74) Name(s) of Attorney(s): **Griffith Hack**
(71) Name(s) and Address(s) of Applicant(s):
Griffith Hack (Melbourne)
GPO BOX 1285 Melbourne VIC 3001 Australia
(72) Name(s) of Designer(s): **Sebastian Ralph Edward Langton**
(45) Registration Date: **28 August 2015**
(30) Convention priority data:
(31) Number (32) Date (33) Country
29/517502 13 Feb 2015 UNITED STATES OF AMERICA
(56) Related Art Documents: **Not Applicable**
(57) Statement of Newness and Distinctiveness: **The shape and configuration of the tracking device is new and distinctive.**



(21) Design Number: **14213/2015**

(22) Date of Filing Application: **17 August 2015**

(24) Date from which industrial property rights may have effect: **17 August 2015**

(54) Product in respect of which the design is registered: **Sanitary faucet**

(51) International Design Classification: **23-01H**

(74) Name(s) of Attorney(s): **Griffith Hack**

(71) Name(s) and Address(s) of Applicant(s):

Hansgrohe SE

Austr. 5-9 Schiltach 77761 Germany

(72) Name(s) of Designer(s): **Tom Schoenherr and Andreas Diefenbach**

(45) Registration Date: **28 August 2015**

(30) Convention priority data:

(31) Number

(32) Date

(33) Country

002636373-0001 18 Feb 2015

**OFFICE FOR HARMONISATION IN
THE INTERNAL MARKET (OHIM)**



(56) Related Art Documents: **Not Applicable**

(57) Statement of Newness and Distinctiveness: **Newness and distinctiveness resides in the shape and configuration of the product as shown in the representations.**

(21) Design Number: **14214/2015**

(22) Date of Filing Application: **17 August 2015**

(24) Date from which industrial property rights may have effect: **17 August 2015**

(54) Product in respect of which the design is registered: **A key blank**

(51) International Design Classification: **08-07**

(74) Name(s) of Attorney(s):

(71) Name(s) and Address(s) of Applicant(s):

TNBT Holdings Pty Ltd

1B/2-6 Greenhills Ave Morebank NSW 2170 Australia

(72) Name(s) of Designer(s): **Zsolt Szarka-Kovacs and Chandrashekar Thippasandra Gangappa**

(45) Registration Date: **28 August 2015**

(56) Related Art Documents: **Not Applicable**

(57) Statement of Newness and Distinctiveness: **The newness and distinctiveness resides in the features of the shape of the shank of the key blank as shown in the accompanying representations. In considering the scope of monopoly, the portion defined by broken lines is to be ignored.**

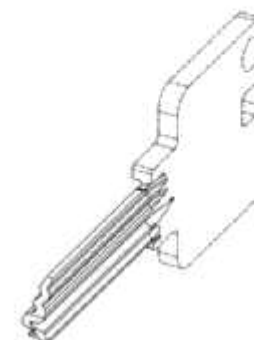

(21) Design Number: **14221/2015**
(22) Date of Filing Application: **17 August 2015**
(24) Date from which industrial property rights may have effect: **17 August 2015**
(54) Product in respect of which the design is registered: **Toy**
(51) International Design Classification: **21-01NES, 24-99**
(74) Name(s) of Attorney(s):
(71) Name(s) and Address(s) of Applicant(s):
Troy Miles
205 Crook St Bendigo VIC 3550 Australia
(72) Name(s) of Designer(s): **Troy Miles**
(45) Registration Date: **28 August 2015**
(56) Related Art Documents: **Not Applicable**
(57) Statement of Newness and Distinctiveness: **Newness and distinctiveness resides in the shape and/or configuration of the toy. The product is used as Chiropractic adjusting toy for kids.**

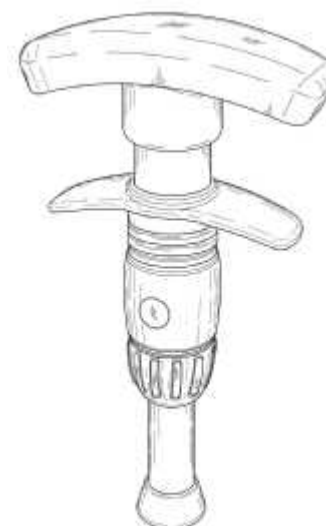

(21) Design Number: **14227/2015**
(22) Date of Filing Application: **18 August 2015**
(24) Date from which industrial property rights may have effect: **18 August 2015**
(54) Product in respect of which the design is registered: **Blender blade support**
(51) International Design Classification: **31-00**
(74) Name(s) of Attorney(s): **Griffith Hack**
(71) Name(s) and Address(s) of Applicant(s):
KENWOOD LIMITED
1 Kenwood Business Park New Lane Havant Hampshire, PO9 2NH
United Kingdom
(72) Name(s) of Designer(s): **Sam Davies**
(45) Registration Date: **28 August 2015**
(30) Convention priority data:
(31) Number (32) Date (33) Country
001430706 19 Feb 2015 OFFICE FOR HARMONISATION IN
THE INTERNAL MARKET (OHIM)
(56) Related Art Documents: **Not Applicable**
(57) Statement of Newness and Distinctiveness: **Newness and distinctiveness resides in the visual features, including shape, configuration, pattern and ornamentation, of a Blender Blade Support as shown in solid render and outline in the accompanying drawings. When determining whether the design is substantially similar in overall impression to another design, particular regard is to be had to the red colour of the stadium-shaped spacer, and no particular regard is to be had to those features shown in dotted outline in the accompanying drawings, which features are provided for illustrative purposes only.**

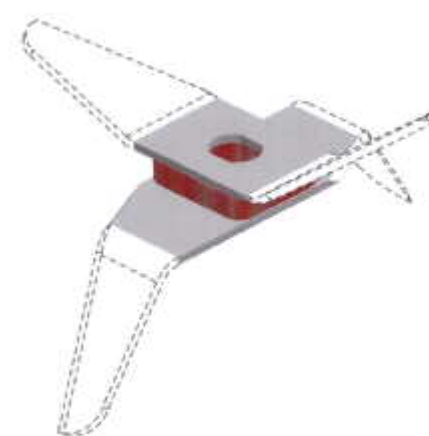

(21) Design Number: **14232/2015**
(22) Date of Filing Application: **18 August 2015**
(24) Date from which industrial property rights may have effect: **18 August 2015**
(54) Product in respect of which the design is registered: **A weight**
(51) International Design Classification: **08-08L, 10-04**
(74) Name(s) of Attorney(s): **EAGAR & MARTIN PTY LTD**
(71) Name(s) and Address(s) of Applicant(s):
Liberation Developments Pty Ltd
L1 172 Evans Rd Salisbury QLD 4031 Australia
(72) Name(s) of Designer(s): **Gregory James Bloom**
(45) Registration Date: **28 August 2015**
(56) Related Art Documents: **Not Applicable**
(57) Statement of Newness and Distinctiveness: **Nil**



(21) Design Number: **16654/2014**
(22) Date of Filing Application: **23 December 2014**
(24) Date from which industrial property rights may have effect: **23 December 2014**
(54) Product in respect of which the design is registered: **Article of clothing**
(51) International Design Classification: **02-02NES**
(74) Name(s) of Attorney(s): **Allens Patent & Trade Mark Attorneys**
(71) Name(s) and Address(s) of Applicant(s):
Forever New Clothing Pty Ltd
714-716 High St Kew East VIC 3102 Australia
(72) Name(s) of Designer(s): **Anna Pham**
(45) Registration Date: **28 August 2015**
(56) Related Art Documents: **Not Applicable**
(57) Statement of Newness and Distinctiveness: **Newness and distinctiveness resides in the visual features of shape, configuration, pattern and/or ornamentation of an article of clothing as shown in the accompanying representations.**



(21) Design Number: **13085/2015**

(22) Date of Filing Application: **18 June 2015**

(24) Date from which industrial property rights may have effect: **18 June 2015**

(54) Product in respect of which the design is registered: **Work platform**

(51) International Design Classification: **21-02F**

(74) Name(s) of Attorney(s): **Davies Collison Cave**

(71) Name(s) and Address(s) of Applicant(s):

Company of Motion, LLC

**218 Helena Ave., Suite D Santa Barbara California, 93101 United States
of America**

(72) Name(s) of Designer(s): **Joel Ward Heath**

(45) Registration Date: **28 August 2015**

(30) Convention priority data:

(31) Number	(32) Date	(33) Country
29/512,569	19 Dec 2014	UNITED STATES OF AMERICA

(56) Related Art Documents: **Not Applicable**

(57) Statement of Newness and Distinctiveness: **Newness and distinctiveness is claimed in the visual features shown in solid lines in the representations. In considering the extent of the design rights, the broken lines shown in the representations are for illustrative purposes only and do not form part of the design.**



(21) Design Number: **13090/2015**

(22) Date of Filing Application: **19 June 2015**

(24) Date from which industrial property rights may have effect: **19 June 2015**

(54) Product in respect of which the design is registered: **Bottle label**

(51) International Design Classification: **19-08**

(74) Name(s) of Attorney(s): **Davies Collison Cave**

(71) Name(s) and Address(s) of Applicant(s):

Nongfu Spring Co., Ltd.

No. 181, Geyazhuang Xihu District Hangzhou Zhejiang 310024 China

(72) Name(s) of Designer(s): **Yi Lu**

(45) Registration Date: **28 August 2015**

(30) Convention priority data:

(31) Number	(32) Date	(33) Country
201530030331.5	02 Feb 2015	CHINA

(56) Related Art Documents: **Not Applicable**

(57) Statement of Newness and Distinctiveness: **Newness and distinctiveness is claimed in the visual features of shape, configuration, pattern and/or ornamentation of a bottle label as shown in the representation.**



(21) Design Number: **13609/2015**
(22) Date of Filing Application: **20 July 2015**
(24) Date from which industrial property rights may have effect: **20 July 2015**
(54) Product in respect of which the design is registered: **Part of a lockable mailbox system**
(51) International Design Classification: **25-03**
(74) Name(s) of Attorney(s): **Shelston IP**
(71) Name(s) and Address(s) of Applicant(s):
PostNL Holding B.V.
Prinses Beatrixlaan 23 Den Haag 2595 AK Netherlands
(72) Name(s) of Designer(s): **Eelco Simon**
(45) Registration Date: **28 August 2015**
(30) Convention priority data:
(31) Number (32) Date (33) Country
002616987-0001 20 Jan 2015 OFFICE FOR HARMONISATION IN THE INTERNAL MARKET (OHIM)

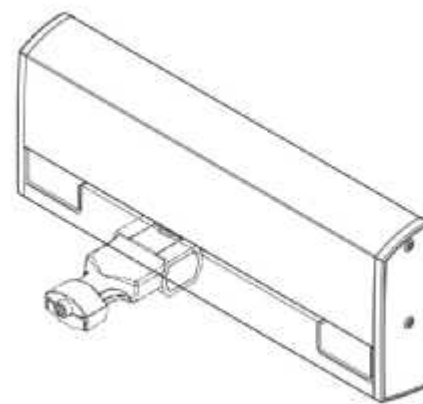

(56) Related Art Documents: **Not Applicable**
(57) Statement of Newness and Distinctiveness: **Newness and distinctiveness reside in the features of shape and/or configuration of PART OF A RELEASABLE MAILBOX SYSTEM as illustrated in solid lines in the accompanying representations. The features shown in broken or discontinuous lines are illustrative only and do not form part of the design.**

(21) Design Number: **13611/2015**
(22) Date of Filing Application: **20 July 2015**
(24) Date from which industrial property rights may have effect: **20 July 2015**
(54) Product in respect of which the design is registered: **Part of a lockable mailbox system**
(51) International Design Classification: **08-07, 25-03**
(74) Name(s) of Attorney(s): **Shelston IP**
(71) Name(s) and Address(s) of Applicant(s):
PostNL Holding B.V.
Prinses Beatrixlaan 23 Den Haag 2595 AK Netherlands
(72) Name(s) of Designer(s): **Eelco Simon**
(45) Registration Date: **28 August 2015**
(30) Convention priority data:
(31) Number (32) Date (33) Country
002616987-0002 20 Jan 2015 OFFICE FOR HARMONISATION IN THE INTERNAL MARKET (OHIM)

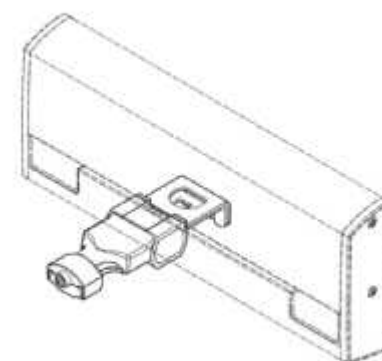

(56) Related Art Documents: **Not Applicable**
(57) Statement of Newness and Distinctiveness: **Newness and distinctiveness reside in the features of shape and/or configuration of PART OF A RELEASABLE MAILBOX SYSTEM as illustrated in solid lines in the accompanying representations. The features shown in broken or discontinuous lines are illustrative only and do not form part of the design.**

(21) Design Number: **14233/2015**

(22) Date of Filing Application: **18 August 2015**

(24) Date from which industrial property rights may have effect: **18 August 2015**

(54) Product in respect of which the design is registered: **Blender base**

(51) International Design Classification: **31-00**

(74) Name(s) of Attorney(s): **Griffith Hack**

(71) Name(s) and Address(s) of Applicant(s):

KENWOOD LIMITED

**1 Kenwood Business Park New Lane Havant Hampshire, PO9 2NH
United Kingdom**

(72) Name(s) of Designer(s): **Sam Davies**

(45) Registration Date: **28 August 2015**

(30) Convention priority data:

(31) Number
001430706

(32) Date
19 Feb 2015

(33) Country
**OFFICE FOR HARMONISATION IN
THE INTERNAL MARKET (OHIM)**

(56) Related Art Documents: **Not Applicable**

(57) Statement of Newness and Distinctiveness: **Newness and distinctiveness resides in the visual features, including shape and configuration, of a Blender Base as shown in solid outline in the accompanying drawings. When determining whether the design is substantially similar in overall impression to another design, no particular regard is to be had to those features shown in dotted outline in the accompanying drawings, which features are provided for illustrative purposes only.**

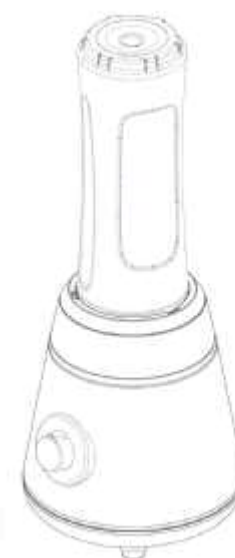

(21) Design Number: **14235/2015**

(22) Date of Filing Application: **18 August 2015**

(24) Date from which industrial property rights may have effect: **18 August 2015**

(54) Product in respect of which the design is registered: **Candle holder**

(51) International Design Classification: **26-01**

(74) Name(s) of Attorney(s): **Sharon Givoni Consulting**

(71) Name(s) and Address(s) of Applicant(s):

Marble Basics Pty Ltd

PO BOX 278 Port Melbourne VIC 3207 Australia

(72) Name(s) of Designer(s): **Bonnie Adams and Bliss Adams**

(45) Registration Date: **28 August 2015**

(56) Related Art Documents: **Not Applicable**

(57) Statement of Newness and Distinctiveness: **Nil**



(21) Design Number: **14234/2015**
(22) Date of Filing Application: **18 August 2015**
(24) Date from which industrial property rights may have effect: **18 August 2015**
(54) Product in respect of which the design is registered: **Control panel for toilets and/or urinals**
(51) International Design Classification: **23-02C**
(74) Name(s) of Attorney(s): **Fisher Adams Kelly Pty Ltd**
(71) Name(s) and Address(s) of Applicant(s):
Geberit International AG
Schachenstrasse 77 JONA 8645 Switzerland
(72) Name(s) of Designer(s): **Christoph Behling**
(45) Registration Date: **28 August 2015**
(30) Convention priority data:
(31) Number (32) Date (33) Country
902720901 24 Jun 2015 WORLD INTELLECTUAL
PROPERTY ORGANIZATION
(WIPO)
(56) Related Art Documents: **Not Applicable**
(57) Statement of Newness and Distinctiveness: **The newness and distinctiveness of the design resides in the shape and/or configuration of a control panel for toilets and/or urinals as shown in the accompanying representations.**

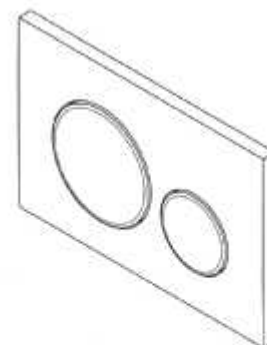

(21) Design Number: **14236/2015**
(22) Date of Filing Application: **18 August 2015**
(24) Date from which industrial property rights may have effect: **18 August 2015**
(54) Product in respect of which the design is registered: **Control knob with collar**
(51) International Design Classification: **31-00**
(74) Name(s) of Attorney(s): **Griffith Hack**
(71) Name(s) and Address(s) of Applicant(s):
KENWOOD LIMITED
1 Kenwood Business Park New Lane Havant Hampshire, PO9 2NH
United Kingdom
(72) Name(s) of Designer(s): **Jamie Weaden and Sam Davies and Darren Mullen**
(45) Registration Date: **28 August 2015**
(30) Convention priority data:
(31) Number (32) Date (33) Country
001430706 18 Feb 2015 OFFICE FOR HARMONISATION IN
THE INTERNAL MARKET (OHIM)
(56) Related Art Documents: **Not Applicable**
(57) Statement of Newness and Distinctiveness: **Newness and distinctiveness resides in the visual features, including shape and configuration, of a Control Knob with Collar as shown in solid outline in the accompanying drawings. When determining whether the design is substantially similar in overall impression to another design, no particular regard is to be had to those features shown in dotted outline in the accompanying drawings, which features are provided for illustrative purposes only.**

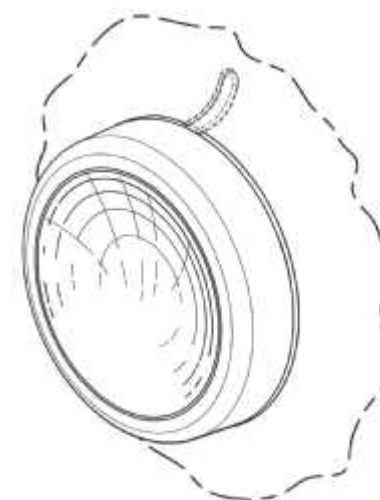

(21) Design Number: **14222/2015**
(22) Date of Filing Application: **18 August 2015**
(24) Date from which industrial property rights may have effect: **18 August 2015**
(54) Product in respect of which the design is registered: **Bottle**
(51) International Design Classification: **09-01NES**
(74) Name(s) of Attorney(s): **Griffith Hack**
(71) Name(s) and Address(s) of Applicant(s):

Pfizer Inc.
235 East 42nd Street New York New York 10017 United States of America

(72) Name(s) of Designer(s): **Matthew Clifton Keller**

(45) Registration Date: **28 August 2015**

(30) Convention priority data:

(31) Number	(32) Date	(33) Country
29/518355	23 Feb 2015	UNITED STATES OF AMERICA

(56) Related Art Documents: **Not Applicable**

(57) Statement of Newness and Distinctiveness: **Newness and distinctiveness resides in the visual features, including shape and configuration, of a BOTTLE as shown in the accompanying drawings.**



(21) Design Number: **14223/2015**
(22) Date of Filing Application: **18 August 2015**
(24) Date from which industrial property rights may have effect: **18 August 2015**
(54) Product in respect of which the design is registered: **Bottle**
(51) International Design Classification: **09-01NES**
(74) Name(s) of Attorney(s): **Griffith Hack**
(71) Name(s) and Address(s) of Applicant(s):

Pfizer Inc.
235 East 42nd Street New York New York 10017 United States of America

(72) Name(s) of Designer(s): **Matthew Clifton Keller**

(45) Registration Date: **28 August 2015**

(30) Convention priority data:

(31) Number	(32) Date	(33) Country
29/518365	23 Feb 2015	UNITED STATES OF AMERICA

(56) Related Art Documents: **Not Applicable**

(57) Statement of Newness and Distinctiveness: **Newness and distinctiveness resides in the visual features, including shape and configuration, of a BOTTLE as shown in the accompanying drawings.**



(21) Design Number: **14224/2015**
(22) Date of Filing Application: **18 August 2015**
(24) Date from which industrial property rights may have effect: **18 August 2015**
(54) Product in respect of which the design is registered: **Bottle**
(51) International Design Classification: **09-01NES**
(74) Name(s) of Attorney(s): **Griffith Hack**
(71) Name(s) and Address(s) of Applicant(s):
Pfizer Inc.
235 East 42nd Street New York New York 10017 United States of America
(72) Name(s) of Designer(s): **Matthew Clifton Keller**
(45) Registration Date: **28 August 2015**
(30) Convention priority data:
(31) Number (32) Date (33) Country
29/518370 23 Feb 2015 UNITED STATES OF AMERICA
(56) Related Art Documents: **Not Applicable**
(57) Statement of Newness and Distinctiveness: **Newness and distinctiveness resides in the visual features, including shape and configuration, of a BOTTLE as shown in the accompanying drawings.**



(21) Design Number: **14210/2015**
(22) Date of Filing Application: **17 August 2015**
(24) Date from which industrial property rights may have effect: **17 August 2015**
(54) Product in respect of which the design is registered: **Cash register**
(51) International Design Classification: **18-01**
(74) Name(s) of Attorney(s): **Shelston IP**
(71) Name(s) and Address(s) of Applicant(s):
Zhejiang Xkeshi Network Technology Co., Ltd.
Room 204, No. 1 Building No. 18 Sanhuaili Lane Xiacheng District Hangzhou Zhejiang China
(72) Name(s) of Designer(s): **Yongliang Zong**
(45) Registration Date: **31 August 2015**
(30) Convention priority data:
(31) Number (32) Date (33) Country
201530048390.5 17 Feb 2015 CHINA
(56) Related Art Documents: **Not Applicable**
(57) Statement of Newness and Distinctiveness: **Newness and distinctiveness reside in the features of shape and/or configuration of a CASH REGISTER as illustrated in the accompanying representations.**



- (21) Design Number: **13540/2015**
(22) Date of Filing Application: **15 July 2015**
(24) Date from which industrial property rights may have effect: **15 July 2015**
(54) Product in respect of which the design is registered: **Key duplicating machines**
(51) International Design Classification: **15-09**
(74) Name(s) of Attorney(s): **Fisher Adams Kelly Pty Ltd**
(71) Name(s) and Address(s) of Applicant(s):
Keyline S.P.A.
Via Camillo Bianchi 2 Conegliano 31015 Italy
(72) Name(s) of Designer(s): **Rino Ferretti**
(45) Registration Date: **31 August 2015**
(30) Convention priority data:
(31) Number (32) Date (33) Country
002614727-0002 16 Jan 2015 OFFICE FOR HARMONISATION IN THE INTERNAL MARKET (OHIM)
(56) Related Art Documents: **Not Applicable**
(57) Statement of Newness and Distinctiveness: **The newness and distinctiveness of the design resides in the shape and/or configuration of a key duplicating machine as shown in the accompanying representations.**



- (21) Design Number: **14146/2015**
(22) Date of Filing Application: **13 August 2015**
(24) Date from which industrial property rights may have effect: **13 August 2015**
(54) Product in respect of which the design is registered: **Paint caddy**
(51) International Design Classification: **08-05L**
(74) Name(s) of Attorney(s):
(71) Name(s) and Address(s) of Applicant(s):
Ben Michael Mayberry
Suite E 8303 East 111th St. Bixby Oklahoma, 74008 United States of America
(72) Name(s) of Designer(s): **Ben Michael Mayberry**
(45) Registration Date: **31 August 2015**
(56) Related Art Documents: **Not Applicable**
(57) Statement of Newness and Distinctiveness: **The shape and configuration of a paint caddy as depicted in the attached representations.**

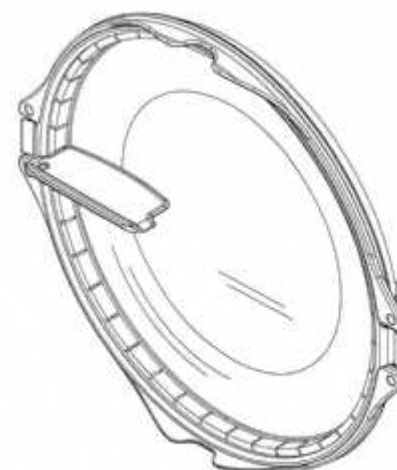

(21) Design Number: **14229/2015**
(22) Date of Filing Application: **18 August 2015**
(24) Date from which industrial property rights may have effect: **18 August 2015**
(54) Product in respect of which the design is registered: **Harness patch**
(51) International Design Classification: **29-02**
(74) Name(s) of Attorney(s): **WADESON**
(71) Name(s) and Address(s) of Applicant(s):
Jamie A Broder
6804 Molokai Circle Boynton Beach FL, 33437 United States of America
(72) Name(s) of Designer(s): **Jamie A Broder**
(45) Registration Date: **31 August 2015**
(30) Convention priority data:
(31) Number (32) Date (33) Country
29/518,000 19 Feb 2015 UNITED STATES OF AMERICA
(56) Related Art Documents: **Not Applicable**
(57) Statement of Newness and Distinctiveness: **Newness and distinctiveness reside in the shape and configuration of the outer periphery, of the patch, shown in the top and bottom views.**



(21) Design Number: **14231/2015**
(22) Date of Filing Application: **18 August 2015**
(24) Date from which industrial property rights may have effect: **18 August 2015**
(54) Product in respect of which the design is registered: **Control knob for a blender**
(51) International Design Classification: **31-00**
(74) Name(s) of Attorney(s): **Griffith Hack**
(71) Name(s) and Address(s) of Applicant(s):
Kenwood Limited
1 Kenwood Business Park New Lane Havant Hampshire PO9 2NH United Kingdom
(72) Name(s) of Designer(s): **Jamie Weaden and Sam Davies and Darren Mullen**
(45) Registration Date: **31 August 2015**
(30) Convention priority data:
(31) Number (32) Date (33) Country
001430706 19 Feb 2015 OFFICE FOR HARMONISATION IN THE INTERNAL MARKET (OHIM)
(56) Related Art Documents: **Not Applicable**
(57) Statement of Newness and Distinctiveness: **Newness and distinctiveness resides in the visual features, including shape and configuration, of a Control Knob for a Blender as shown in solid outline in the accompanying drawings. When determining whether the design is substantially similar in overall impression to another design, no particular regard is to be had to those features shown in dotted outline in the accompanying drawings, which features are provided for illustrative purposes only.**



(21) Design Number: **14245/2015**

(22) Date of Filing Application: **18 August 2015**

(24) Date from which industrial property rights may have effect: **18 August 2015**

(54) Product in respect of which the design is registered: **Fruit cutter**

(51) International Design Classification: **31-00, 07-04**

(74) Name(s) of Attorney(s):

(71) Name(s) and Address(s) of Applicant(s):

**Monkey Business design Israel Ltd.
3 Hebron st. Tel Aviv 6314903 Israel**

(72) Name(s) of Designer(s): **Avihai Shurin**

(45) Registration Date: **31 August 2015**

(30) Convention priority data:

(31) Number (32) Date
002708685-0001 28 May 2015

(33) Country
**OFFICE FOR HARMONISATION IN
THE INTERNAL MARKET (OHIM)**

(56) Related Art Documents: **Not Applicable**

(57) Statement of Newness and Distinctiveness: **Nil**

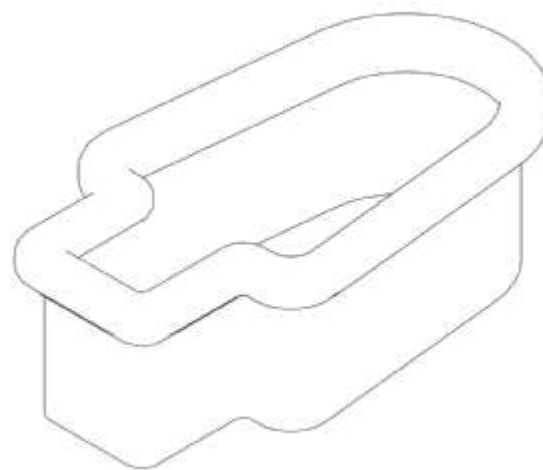

(21) Design Number: **14261/2015**

(22) Date of Filing Application: **19 August 2015**

(24) Date from which industrial property rights may have effect: **19 August 2015**

(54) Product in respect of which the design is registered: **Stroller**

(51) International Design Classification: **12-12**

(74) Name(s) of Attorney(s):

(71) Name(s) and Address(s) of Applicant(s):

**REDSBABY PTY. LTD.
PO BOX 3033 Bellevue Hill NSW 2023 Australia**

(72) Name(s) of Designer(s): **Meagan Redelman**

(45) Registration Date: **31 August 2015**

(56) Related Art Documents: **Not Applicable**

(57) Statement of Newness and Distinctiveness: **The newness and distinctiveness of the design resides in the overall shape and/or configuration of a pram/stroller as illustrated in the accompanying representations. Particular emphasis is placed on the newness and distinctiveness of the shape and configuration of the soft goods materials design (canopy, seat unit design, harness padding design) in conjunction with the hard goods design (front and rear wheels, handlebar, chassis etc).**



(21) Design Number: **14266/2015**
(22) Date of Filing Application: **19 August 2015**
(24) Date from which industrial property rights may have effect: **19 August 2015**
(54) Product in respect of which the design is registered: **Bracelet**
(51) International Design Classification: **11-01C, 10-02**
(74) Name(s) of Attorney(s): **WATERMARK PATENT AND TRADE MARKS ATTORNEYS**
(71) Name(s) and Address(s) of Applicant(s):
Swatch AG (Swatch SA) (Swatch Ltd.)
Jakob-Stampfli-Strasse 94 Biel/Bienne 2502 Switzerland
(72) Name(s) of Designer(s): **Matthias Zah**
(45) Registration Date: **31 August 2015**
(30) Convention priority data:
(31) Number (32) Date (33) Country
DM/085 694 23 Feb 2015 WORLD INTELLECTUAL PROPERTY ORGANIZATION (WIPO)
(56) Related Art Documents: **Not Applicable**
(57) Statement of Newness and Distinctiveness: **Nil**



(21) Design Number: **13432/2015**
(22) Date of Filing Application: **08 July 2015**
(24) Date from which industrial property rights may have effect: **08 July 2015**
(54) Product in respect of which the design is registered: **Pocket**
(51) International Design Classification: **02-02B**
(74) Name(s) of Attorney(s):
(71) Name(s) and Address(s) of Applicant(s):
Industrie IP Pty Limited
55 Railway Pde Marrickville NSW 2204 Australia
(72) Name(s) of Designer(s): **Nicholas Kelly**
(45) Registration Date: **31 August 2015**
(56) Related Art Documents: **Not Applicable**
(57) Statement of Newness and Distinctiveness: **Newness and distinctiveness is claimed in the overall shape, configuration, pattern and/or ornamentation of the pocket with double entry as depicted in the accompanying representation. The outline of the trouser on which the pocket sits is not claimed as a feature of the design.**

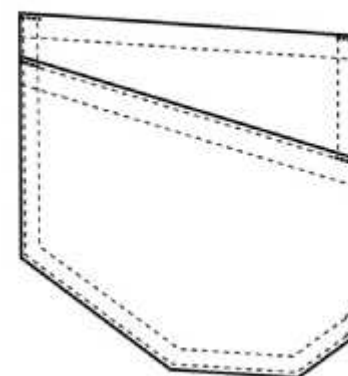

(21) Design Number: **13945/2015**
(22) Date of Filing Application: **04 August 2015**
(24) Date from which industrial property rights may have effect: **04 August 2015**
(54) Product in respect of which the design is registered: **Drill handle**
(51) International Design Classification: **08-01**
(74) Name(s) of Attorney(s): **Freehills Patent Attorneys**
(71) Name(s) and Address(s) of Applicant(s):
Gyrus Acmi, Inc. (d/b/a Olympus Surgical Technologies America)
136 Turnpike Rd. Southborough Massachusetts, 01772 United States of America
(72) Name(s) of Designer(s): **Kevin C. Edwards and Jay A. Casey and Peter Wong and Jesse Conrad and Manfred Held and Ronny Staps**
(45) Registration Date: **31 August 2015**
(30) Convention priority data:
(31) Number (32) Date (33) Country
29/524747 23 Apr 2015 UNITED STATES OF AMERICA
(56) Related Art Documents: **Not Applicable**
(57) Statement of Newness and Distinctiveness: **Newness and distinctiveness of the design resides in the features of shape and configuration of the handle as shown in solid outline in the accompanying drawings.**

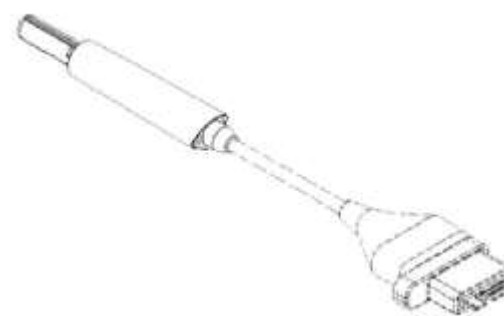

(21) Design Number: **14108/2015**
(22) Date of Filing Application: **11 August 2015**
(24) Date from which industrial property rights may have effect: **11 August 2015**
(54) Product in respect of which the design is registered: **Car handle**
(51) International Design Classification: **12-16NES**
(74) Name(s) of Attorney(s): **Callinans**
(71) Name(s) and Address(s) of Applicant(s):
E. Mishan & Sons, Inc.
230 Fifth Avenue New York, New York, 10001 United States of America
(72) Name(s) of Designer(s): **Daniel Deng and Debbie Feuerstein and Fred Hollinger**
(45) Registration Date: **31 August 2015**
(30) Convention priority data:
(31) Number (32) Date (33) Country
29/517,992 19 Feb 2015 UNITED STATES OF AMERICA
(56) Related Art Documents: **Not Applicable**
(57) Statement of Newness and Distinctiveness: **Nil**

1/6



PERSPECTIVE VIEW

(21) Design Number: **14110/2015**
(22) Date of Filing Application: **11 August 2015**
(24) Date from which industrial property rights may have effect: **11 August 2015**
(54) Product in respect of which the design is registered: **Car handle**
(51) International Design Classification: **12-16NES**
(74) Name(s) of Attorney(s): **Callinans**
(71) Name(s) and Address(s) of Applicant(s):
E. Mishan & Sons, Inc.
230 Fifth Avenue New York, New York, 10001 United States of America
(72) Name(s) of Designer(s): **Daniel Deng and Debbie Feuerstein and Fred Hollinger**
(45) Registration Date: **31 August 2015**
(30) Convention priority data:
(31) Number (32) Date (33) Country
29/517,992 19 Feb 2015 UNITED STATES OF AMERICA
(56) Related Art Documents: **Not Applicable**
(57) Statement of Newness and Distinctiveness: **Nil**

1/7



PERSPECTIVE VIEW

(21) Design Number: **14111/2015**
(22) Date of Filing Application: **11 August 2015**
(24) Date from which industrial property rights may have effect: **11 August 2015**
(54) Product in respect of which the design is registered: **Car hoop handle**
(51) International Design Classification: **12-16NES**
(74) Name(s) of Attorney(s): **Callinans**
(71) Name(s) and Address(s) of Applicant(s):
E. Mishan & Sons, Inc.
230 Fifth Avenue New York, New York, 10001 United States of America
(72) Name(s) of Designer(s): **Daniel Deng and Debbie Feuerstein and Fred Hollinger**
(45) Registration Date: **31 August 2015**
(30) Convention priority data:
(31) Number (32) Date (33) Country
29/526,110 06 May 2015 UNITED STATES OF AMERICA
(56) Related Art Documents: **Not Applicable**
(57) Statement of Newness and Distinctiveness: **Nil**

1/6



PERSPECTIVE VIEW

(21) Design Number: **14112/2015**
(22) Date of Filing Application: **11 August 2015**
(24) Date from which industrial property rights may have effect: **11 August 2015**
(54) Product in respect of which the design is registered: **Car hoop handle**
(51) International Design Classification: **12-16NES**
(74) Name(s) of Attorney(s): **Callinans**
(71) Name(s) and Address(s) of Applicant(s):
E. Mishan & Sons, Inc.
230 Fifth Avenue New York, New York, 10001 United States of America
(72) Name(s) of Designer(s): **Daniel Deng and Debbie Feuerstein and Fred Hollinger**
(45) Registration Date: **31 August 2015**
(30) Convention priority data:
(31) Number (32) Date (33) Country
29/526,110 06 May 2015 UNITED STATES OF AMERICA
(56) Related Art Documents: **Not Applicable**
(57) Statement of Newness and Distinctiveness: **Nil**

1/6



PERSPECTIVE VIEW

(21) Design Number: **11124/2015**
(22) Date of Filing Application: **02 March 2015**
(24) Date from which industrial property rights may have effect: **02 March 2015**
(54) Product in respect of which the design is registered: **Automobile**
(51) International Design Classification: **12-08**
(74) Name(s) of Attorney(s): **Spruson & Ferguson**
(71) Name(s) and Address(s) of Applicant(s):
Toyota Jidosha Kabushiki Kaisha
1, Toyota-cho, Toyota-shi, Aichi-ken 471-8571 Japan
(72) Name(s) of Designer(s): **Satoshi Okamoto and Takanori Ito and Tokuharu Mino**
(45) Registration Date: **31 August 2015**
(56) Related Art Documents: **Not Applicable**
(57) Statement of Newness and Distinctiveness: **Newness and distinctiveness is claimed in the features of the shape and/or configuration of an automobile as illustrated in the accompanying representations, apart from Toyota emblems.**



- (21) Design Number: **11125/2015**
(22) Date of Filing Application: **02 March 2015**
(24) Date from which industrial property rights may have effect: **02 March 2015**
(54) Product in respect of which the design is registered: **Front combination lamp for an automobile**
(51) International Design Classification: **12-16E**
(74) Name(s) of Attorney(s): **Spruson & Ferguson**
(71) Name(s) and Address(s) of Applicant(s):
Toyota Jidosha Kabushiki Kaisha
1, Toyota-cho, Toyota-shi, Aichi-ken 471-8571 Japan
(72) Name(s) of Designer(s): **Guangxu Jin**
(45) Registration Date: **31 August 2015**
(56) Related Art Documents: **Not Applicable**
(57) Statement of Newness and Distinctiveness: **Newness and distinctiveness is claimed in the features of the shape and/or configuration of a front combination lamp for an automobile as illustrated in the accompanying representations, apart from attachment lugs.**



- (21) Design Number: **11126/2015**
(22) Date of Filing Application: **02 March 2015**
(24) Date from which industrial property rights may have effect: **02 March 2015**
(54) Product in respect of which the design is registered: **Front combination lamp for an automobile**
(51) International Design Classification: **12-16E**
(74) Name(s) of Attorney(s): **Spruson & Ferguson**
(71) Name(s) and Address(s) of Applicant(s):
Toyota Jidosha Kabushiki Kaisha
1, Toyota-cho, Toyota-shi, Aichi-ken 471-8571 Japan
(72) Name(s) of Designer(s): **Guangxu Jin**
(45) Registration Date: **31 August 2015**
(56) Related Art Documents: **Not Applicable**
(57) Statement of Newness and Distinctiveness: **Newness and distinctiveness is claimed in the features of the shape and/or configuration of a front combination lamp for an automobile as illustrated in the accompanying representations, apart from attachment lugs.**



- (21) Design Number: **11127/2015**
(22) Date of Filing Application: **02 March 2015**
(24) Date from which industrial property rights may have effect: **02 March 2015**
(54) Product in respect of which the design is registered: **Front bumper for an automobile**
(51) International Design Classification: **12-16C**
(74) Name(s) of Attorney(s): **Spruson & Ferguson**
(71) Name(s) and Address(s) of Applicant(s):
Toyota Jidosha Kabushiki Kaisha
1, Toyota-cho, Toyota-shi, Aichi-ken 471-8571 Japan
(72) Name(s) of Designer(s): **Hideki Hayashi and Tokuharu Mino and Takanori Ito**
(45) Registration Date: **31 August 2015**
(56) Related Art Documents: **Not Applicable**
(57) Statement of Newness and Distinctiveness: **Newness and distinctiveness is claimed in the features of the shape and/or configuration of a front bumper for an automobile as illustrated in the accompanying representations, apart from attachment lugs.**



- (21) Design Number: **11128/2015**
(22) Date of Filing Application: **02 March 2015**
(24) Date from which industrial property rights may have effect: **02 March 2015**
(54) Product in respect of which the design is registered: **Rear combination lamp for an automobile**
(51) International Design Classification: **12-16E**
(74) Name(s) of Attorney(s): **Spruson & Ferguson**
(71) Name(s) and Address(s) of Applicant(s):
Toyota Jidosha Kabushiki Kaisha
1, Toyota-cho, Toyota-shi, Aichi-ken 471-8571 Japan
(72) Name(s) of Designer(s): **Makoto Takahashi**
(45) Registration Date: **31 August 2015**
(56) Related Art Documents: **Not Applicable**
(57) Statement of Newness and Distinctiveness: **Newness and distinctiveness is claimed in the features of the shape and/or configuration of a rear combination lamp for an automobile as illustrated in the accompanying representations, apart from attachment lugs.**



- (21) Design Number: **11129/2015**
(22) Date of Filing Application: **02 March 2015**
(24) Date from which industrial property rights may have effect: **02 March 2015**
(54) Product in respect of which the design is registered: **Rear bumper for an automobile**
(51) International Design Classification: **12-16C**
(74) Name(s) of Attorney(s): **Spruson & Ferguson**
(71) Name(s) and Address(s) of Applicant(s):
Toyota Jidosha Kabushiki Kaisha
1, Toyota-cho, Toyota-shi, Aichi-ken 471-8571 Japan
(72) Name(s) of Designer(s): **Satoshi Okamoto and Makoto Takahashi**
(45) Registration Date: **31 August 2015**
(56) Related Art Documents: **Not Applicable**
(57) Statement of Newness and Distinctiveness: **Newness and distinctiveness is claimed in the features of the shape and/or configuration of a rear bumper for an automobile as illustrated in the accompanying representations, apart from attachment lugs.**



- (21) Design Number: **14277/2015**
(22) Date of Filing Application: **20 August 2015**
(24) Date from which industrial property rights may have effect: **20 August 2015**
(54) Product in respect of which the design is registered: **Wheel for vehicle**
(51) International Design Classification: **12-16A**
(74) Name(s) of Attorney(s): **Spruson & Ferguson**
(71) Name(s) and Address(s) of Applicant(s):
Daimler AG
Mercedesstrasse 137 Stuttgart D-70327 Germany
(72) Name(s) of Designer(s): **Bernhard Hans and Kai Hilpert**
(45) Registration Date: **01 September 2015**
(30) Convention priority data:
(31) Number (32) Date (33) Country
DM/085744 26 Feb 2015 SWITZERLAND
(WIPO42177)
(56) Related Art Documents: **Not Applicable**
(57) Statement of Newness and Distinctiveness: **Newness and distinctiveness is claimed in the features of shape and/or configuration of a wheel for vehicle as illustrated in the accompanying representations.**



(21) Design Number: **14278/2015**
(22) Date of Filing Application: **20 August 2015**
(24) Date from which industrial property rights may have effect: **20 August 2015**
(54) Product in respect of which the design is registered: **Dry pipe vapourizer**
(51) International Design Classification: **27-02**
(74) Name(s) of Attorney(s):
(71) Name(s) and Address(s) of Applicant(s):
TRIO BROTHERS TRADING PTY LTD
18 Beal St Meadowbrook QLD 4131 Australia
(72) Name(s) of Designer(s): **Jack Qin**
(45) Registration Date: **01 September 2015**
(56) Related Art Documents: **Not Applicable**
(57) Statement of Newness and Distinctiveness: **2 in 1. Dry pipe & vapourizer.**



(21) Design Number: **14279/2015**
(22) Date of Filing Application: **20 August 2015**
(24) Date from which industrial property rights may have effect: **20 August 2015**
(54) Product in respect of which the design is registered: **Speakerphone**
(51) International Design Classification: **14-03A**
(74) Name(s) of Attorney(s): **Fisher Adams Kelly Pty Ltd**
(71) Name(s) and Address(s) of Applicant(s):
Polycom, Inc.
6001 America Center Drive San Jose California 95002 United States of America
(72) Name(s) of Designer(s): **Crispian Tompkin and Luke David Springer and Anthony Martin Duys and Alexander Baker Ekrot**
(45) Registration Date: **01 September 2015**
(30) Convention priority data:
(31) Number (32) Date (33) Country
29/518227 20 Feb 2015 UNITED STATES OF AMERICA
(56) Related Art Documents: **Not Applicable**
(57) Statement of Newness and Distinctiveness: **The newness and distinctiveness resides in the shape and/or configuration of the speakerphone as shown in the attached representations. When assessing the newness and distinctiveness of the speakerphone no consideration should be given to those portions of the speakerphone shown in dashed lines in the attached representations.**

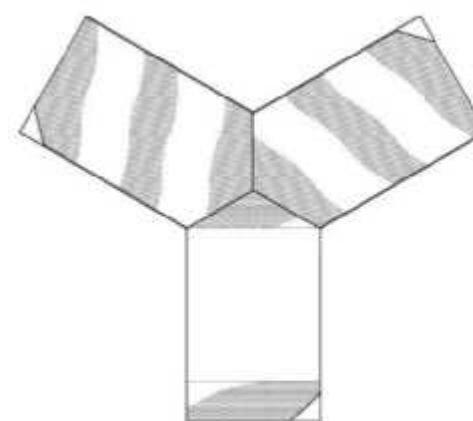

(21) Design Number: **14282/2015**
(22) Date of Filing Application: **20 August 2015**
(24) Date from which industrial property rights may have effect: **20 August 2015**
(54) Product in respect of which the design is registered: **Digital spray gun**
(51) International Design Classification: **08-05L**
(74) Name(s) of Attorney(s): **WATERMARK PATENT AND TRADE MARKS ATTORNEYS**
(71) Name(s) and Address(s) of Applicant(s):
Zhejiang Auarita Pneumatic Tools L.L.C
Shuian Industrial Zone Ruoheng Wenling City Zhejiang China
(72) Name(s) of Designer(s): **Banfa Lin**
(45) Registration Date: **01 September 2015**
(56) Related Art Documents: **Not Applicable**
(57) Statement of Newness and Distinctiveness: **Nil**



(21) Design Number: **14283/2015**
(22) Date of Filing Application: **20 August 2015**
(24) Date from which industrial property rights may have effect: **20 August 2015**
(54) Product in respect of which the design is registered: **A clip for a tourniquet**
(51) International Design Classification: **24-04**
(74) Name(s) of Attorney(s): **Chrysiliou IP**
(71) Name(s) and Address(s) of Applicant(s):
Multigate Medical Products Pty Ltd
27 Llewellyn Ave Villawood NSW 2163 Australia
(72) Name(s) of Designer(s): **Ben Chen**
(45) Registration Date: **01 September 2015**
(56) Related Art Documents: **Not Applicable**
(57) Statement of Newness and Distinctiveness: **The newness and distinctiveness of the design resides in the feature and configuration of the highlighted parts of the clip as shown in the accompanying representations.**



- (21) Design Number: **14284/2015**
(22) Date of Filing Application: **20 August 2015**
(24) Date from which industrial property rights may have effect: **20 August 2015**
(54) Product in respect of which the design is registered: **Powered barrow**
(51) International Design Classification: **12-02**
(74) Name(s) of Attorney(s): **WATERMARK PATENT AND TRADE MARKS ATTORNEYS**
(71) Name(s) and Address(s) of Applicant(s):
Nantong ANT Machinery Co. Ltd.
No.280 Fuyuan Road Economic Development Area Qidong City Jiangsu Province, 226000 China
(72) Name(s) of Designer(s): **Chen Yu**
(45) Registration Date: **01 September 2015**
(56) Related Art Documents: **Not Applicable**
(57) Statement of Newness and Distinctiveness: **Newness and distinctiveness reside in the visual features of a powered barrow as shown in the accompanying representations. In considering newness and distinctiveness, particular regard is to be taken of the handle on the bucket to aid unloading, the engine guard to protect an operator from the engine, the covered chain drive and the gearbox cover to protect the gearbox.**

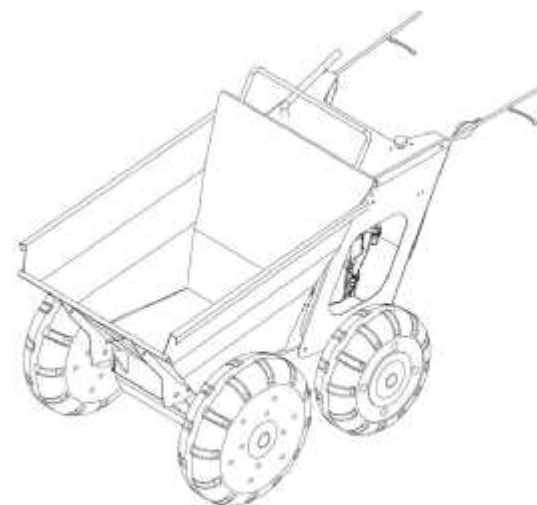

- (21) Design Number: **14286/2015**
(22) Date of Filing Application: **20 August 2015**
(24) Date from which industrial property rights may have effect: **20 August 2015**
(54) Product in respect of which the design is registered: **Golf club head**
(51) International Design Classification: **21-02C**
(74) Name(s) of Attorney(s): **Pizzeys Patent and Trade Mark Attorneys Pty Ltd**
(71) Name(s) and Address(s) of Applicant(s):
Point-n-Putt Pty. Ltd.
PO BOX 9088 Deakin ACT 2600 Australia
(72) Name(s) of Designer(s): **Paul Joseph Donaghue**
(45) Registration Date: **01 September 2015**
(56) Related Art Documents: **Not Applicable**
(57) Statement of Newness and Distinctiveness: **Nil**



- (21) Design Number: **14287/2015**
(22) Date of Filing Application: **20 August 2015**
(24) Date from which industrial property rights may have effect: **20 August 2015**
(54) Product in respect of which the design is registered: **Golf club head**
(51) International Design Classification: **21-02C**
(74) Name(s) of Attorney(s): **Pizzeys Patent and Trade Mark Attorneys Pty Ltd**
(71) Name(s) and Address(s) of Applicant(s):
Point-n-Putt Pty. Ltd.
PO BOX 9088 Deakin ACT 2600 Australia
(72) Name(s) of Designer(s): **Paul Joseph Donaghue**
(45) Registration Date: **01 September 2015**
(56) Related Art Documents: **Not Applicable**
(57) Statement of Newness and Distinctiveness: **Nil**

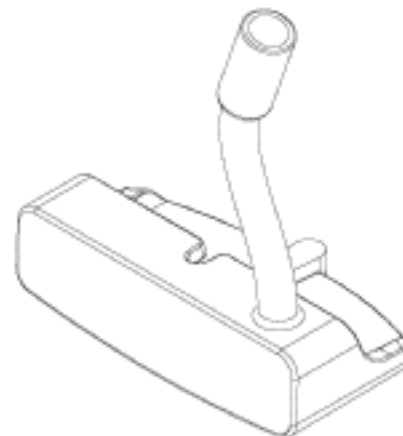

- (21) Design Number: **14285/2015**
(22) Date of Filing Application: **20 August 2015**
(24) Date from which industrial property rights may have effect: **20 August 2015**
(54) Product in respect of which the design is registered: **Powered barrow**
(51) International Design Classification: **12-02**
(74) Name(s) of Attorney(s): **WATERMARK PATENT AND TRADE MARKS ATTORNEYS**
(71) Name(s) and Address(s) of Applicant(s):
Nantong ANT Machinery Co. Ltd.
No.280 Fuyuan Road Economic Development Area Qidong City Jiangsu Province, 226000 China
(72) Name(s) of Designer(s): **Chen Yu**
(45) Registration Date: **01 September 2015**
(56) Related Art Documents: **Not Applicable**
(57) Statement of Newness and Distinctiveness: **Newness and distinctiveness reside in the visual features of a powered barrow as shown in the accompanying representations. In considering newness and distinctiveness, particular regard is to be taken of the high volume bucket with increased dimensions for greater load carrying capacity, the engine guard to protect an operator from the engine, the covered chain drive and the gearbox cover to protect the gearbox.**



(21) Design Number: **14288/2015**
(22) Date of Filing Application: **21 August 2015**
(24) Date from which industrial property rights may have effect: **21 August 2015**
(54) Product in respect of which the design is registered: **Tablet computer**
(51) International Design Classification: **14-02**
(74) Name(s) of Attorney(s): **FB Rice**
(71) Name(s) and Address(s) of Applicant(s):
LG Electronics Inc.
128, Yeoui-daero, Yeongdeungpo-gu Seoul 150-721 Republic of Korea
(72) Name(s) of Designer(s): **Seala Park and Seungchul Cho and Min Kim**
(45) Registration Date: **01 September 2015**
(30) Convention priority data:
(31) Number (32) Date (33) Country
30-2015-0008977 23 Feb 2015 REPUBLIC OF KOREA
(56) Related Art Documents: **Not Applicable**
(57) Statement of Newness and Distinctiveness: **Newness and distinctiveness reside in the features of the design shown in solid lines in representations excluding those features shown in broken lines.**



(21) Design Number: **13155/2015**
(22) Date of Filing Application: **22 June 2015**
(24) Date from which industrial property rights may have effect: **22 June 2015**
(54) Product in respect of which the design is registered: **Electrical muscle stimulator**
(51) International Design Classification: **21-02NES**
(74) Name(s) of Attorney(s): **Spruson & Ferguson**
(71) Name(s) and Address(s) of Applicant(s):
MTG Co., Ltd.
32, Honjin-dori 2-chome, Nakamura-ku, Nagoya-shi Aichi-ken, 453-0041 Japan
(72) Name(s) of Designer(s): **Tsuyoshi Matsushita**
(45) Registration Date: **01 September 2015**
(30) Convention priority data:
(31) Number (32) Date (33) Country
2015-003405 19 Feb 2015 JAPAN
(56) Related Art Documents: **Not Applicable**
(57) Statement of Newness and Distinctiveness: **Newness and distinctiveness is claimed in the features of shape and/or configuration of an electrical muscle stimulator as illustrated in the accompanying representations.**

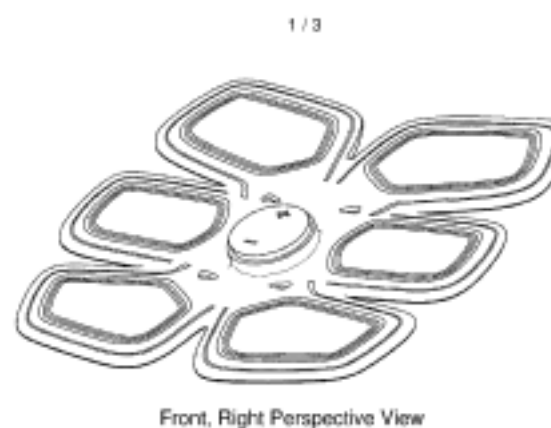

- (21) Design Number: **13156/2015**
(22) Date of Filing Application: **22 June 2015**
(24) Date from which industrial property rights may have effect: **22 June 2015**
(54) Product in respect of which the design is registered: **Electrical muscle stimulator**
(51) International Design Classification: **21-02NES**
(74) Name(s) of Attorney(s): **Spruson & Ferguson**
(71) Name(s) and Address(s) of Applicant(s):
MTG Co., Ltd.
32, Honjin-dori 2-chome, Nakamura-ku, Nagoya-shi Aichi-ken, 453-0041
Japan
(72) Name(s) of Designer(s): **Tsuyoshi Matsushita**
(45) Registration Date: **01 September 2015**
(30) Convention priority data:
(31) Number (32) Date (33) Country
2015-004296 27 Feb 2015 JAPAN
(56) Related Art Documents: **Not Applicable**
(57) Statement of Newness and Distinctiveness: **Newness and distinctiveness is claimed in the features of shape and/or configuration of an electrical muscle stimulator as illustrated in the accompanying representations.**

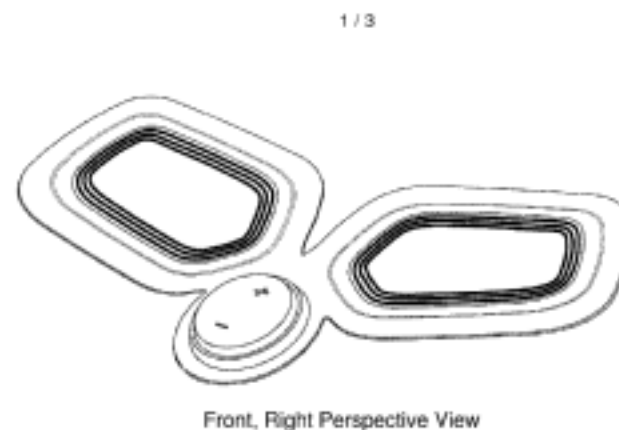

- (21) Design Number: **14296/2015**
(22) Date of Filing Application: **21 August 2015**
(24) Date from which industrial property rights may have effect: **21 August 2015**
(54) Product in respect of which the design is registered: **A glove**
(51) International Design Classification: **02-06**
(74) Name(s) of Attorney(s): **Fisher Adams Kelly Pty Ltd**
(71) Name(s) and Address(s) of Applicant(s):
Marco Lorenzo Giaroli
51 Cairns St Red Hill QLD, 4059 Australia
(72) Name(s) of Designer(s): **Marco Lorenzo Giaroli**
(45) Registration Date: **01 September 2015**
(56) Related Art Documents: **Not Applicable**
(57) Statement of Newness and Distinctiveness: **Newness and distinctiveness of the design resides in the shape and/or configuration of a glove as shown in the representations. The lines in phantom line should not taken into consideration when assessing the scope of the design.**



(21) Design Number: **14289/2015**
(22) Date of Filing Application: **21 August 2015**
(24) Date from which industrial property rights may have effect: **21 August 2015**
(54) Product in respect of which the design is registered: **Tablet computer**
(51) International Design Classification: **14-02**
(74) Name(s) of Attorney(s): **FB Rice**
(71) Name(s) and Address(s) of Applicant(s):
LG Electronics Inc.
128, Yeoui-daero, Yeongdeungpo-gu Seoul 150-721 Republic of Korea
(72) Name(s) of Designer(s): **Seala Park and Seungchul Cho and Min Kim**
(45) Registration Date: **02 September 2015**
(30) Convention priority data:
(31) Number (32) Date (33) Country
30-2015-0008979 23 Feb 2015 REPUBLIC OF KOREA
(56) Related Art Documents: **Not Applicable**
(57) Statement of Newness and Distinctiveness: **Newness and distinctiveness reside in the features of the design shown in solid lines in representations excluding those features shown in broken lines.**



(21) Design Number: **14291/2015**
(22) Date of Filing Application: **21 August 2015**
(24) Date from which industrial property rights may have effect: **21 August 2015**
(54) Product in respect of which the design is registered: **Bag carrier**
(51) International Design Classification: **08-08G**
(74) Name(s) of Attorney(s): **Cullens Patent and Trade Mark Attorneys**
(71) Name(s) and Address(s) of Applicant(s):
X TEC Pty Ltd
C/-L32 239 George St Brisbane QLD 4000 Australia
(72) Name(s) of Designer(s): **Chris O'Neill and Dallyn Seale**
(45) Registration Date: **02 September 2015**
(56) Related Art Documents: **Not Applicable**
(57) Statement of Newness and Distinctiveness: **Nil**

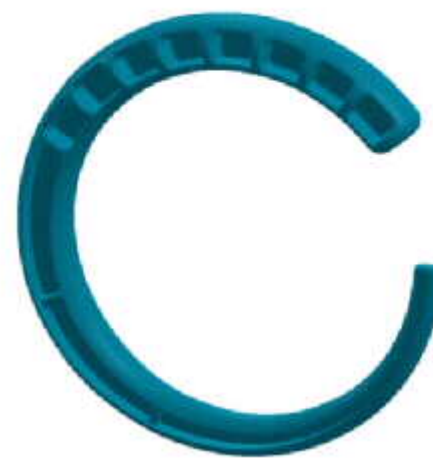

- (21) Design Number: **14292/2015**
(22) Date of Filing Application: **21 August 2015**
(24) Date from which industrial property rights may have effect: **21 August 2015**
(54) Product in respect of which the design is registered: **A glove**
(51) International Design Classification: **02-06**
(74) Name(s) of Attorney(s): **Fisher Adams Kelly Pty Ltd**
(71) Name(s) and Address(s) of Applicant(s):
Marco Lorenzo Giaroli
51 Cairns St Red Hill QLD 4059 Australia
(72) Name(s) of Designer(s): **Marco Lorenzo Giaroli**
(45) Registration Date: **02 September 2015**
(56) Related Art Documents: **Not Applicable**
(57) Statement of Newness and Distinctiveness: **Newness and distinctiveness of the design resides in the shape and/or configuration of a glove as shown in the representations. The lines in phantom line should not taken into consideration when assessing the scope of the design.**

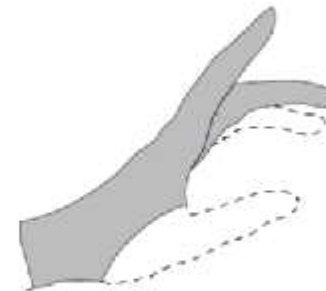

- (21) Design Number: **14293/2015**
(22) Date of Filing Application: **21 August 2015**
(24) Date from which industrial property rights may have effect: **21 August 2015**
(54) Product in respect of which the design is registered: **A glove**
(51) International Design Classification: **02-06**
(74) Name(s) of Attorney(s): **Fisher Adams Kelly Pty Ltd**
(71) Name(s) and Address(s) of Applicant(s):
Marco Lorenzo Giaroli
51 Cairns St Red Hill QLD, 4059 Australia
(72) Name(s) of Designer(s): **Marco Lorenzo Giaroli**
(45) Registration Date: **02 September 2015**
(56) Related Art Documents: **Not Applicable**
(57) Statement of Newness and Distinctiveness: **Newness and distinctiveness of the design resides in the shape and/or configuration of a glove as shown in the representations. The lines in phantom line should not taken into consideration when assessing the scope of the design.**

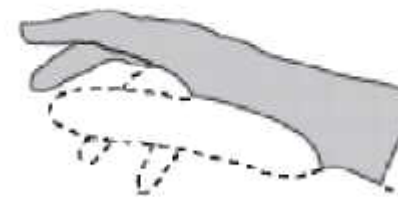

- (21) Design Number: **14294/2015**
(22) Date of Filing Application: **21 August 2015**
(24) Date from which industrial property rights may have effect: **21 August 2015**
(54) Product in respect of which the design is registered: **A glove**
(51) International Design Classification: **02-06**
(74) Name(s) of Attorney(s): **Fisher Adams Kelly Pty Ltd**
(71) Name(s) and Address(s) of Applicant(s):
Marco Lorenzo Giaroli
51 Cairns St Red Hill QLD, 4059 Australia
(72) Name(s) of Designer(s): **Marco Lorenzo Giaroli**
(45) Registration Date: **02 September 2015**
(56) Related Art Documents: **Not Applicable**
(57) Statement of Newness and Distinctiveness: **Newness and distinctiveness of the design resides in the shape and/or configuration of a glove as shown in the representations. The lines in phantom line should not taken into consideration when assessing the scope of the design.**

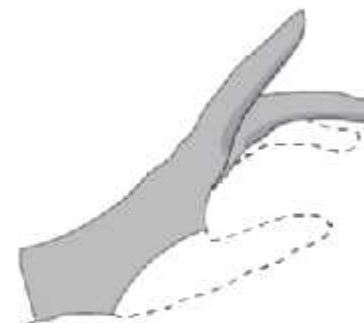

- (21) Design Number: **14295/2015**
(22) Date of Filing Application: **21 August 2015**
(24) Date from which industrial property rights may have effect: **21 August 2015**
(54) Product in respect of which the design is registered: **Chandelier**
(51) International Design Classification: **26-05D**
(74) Name(s) of Attorney(s):
(71) Name(s) and Address(s) of Applicant(s):
Belinda May Hall
Se 1&2, 103-105 Keira St Wollongong NSW, 2500 Australia
(72) Name(s) of Designer(s): **Belinda May Hall**
(45) Registration Date: **02 September 2015**
(56) Related Art Documents: **Not Applicable**
(57) Statement of Newness and Distinctiveness: **What distinguishes the chandelier is the use of wallpaper. It's a wallpaper chandelier. In this case a vintage wallpaper.**



- (21) Design Number: **12970/2015**
(22) Date of Filing Application: **12 June 2015**
(24) Date from which industrial property rights may have effect: **12 June 2015**
(54) Product in respect of which the design is registered: **Golf club**
(51) International Design Classification: **21-02C**
(74) Name(s) of Attorney(s): **Burns IP & Commercial**
(71) Name(s) and Address(s) of Applicant(s):
PBK Golf Pty Ltd
79 Weatherall Rd Cheltenham VIC 3192 Australia
(72) Name(s) of Designer(s): **Paul Buchanan and Ben Hood and Kane Streat**
(45) Registration Date: **02 September 2015**
(56) Related Art Documents: **Not Applicable**
(57) Statement of Newness and Distinctiveness: **The newness and distinctiveness of the design resides in the grind of the golf club as shown in the attached photographs.**



- (21) Design Number: **13073/2015**
(22) Date of Filing Application: **18 June 2015**
(24) Date from which industrial property rights may have effect: **18 June 2015**
(54) Product in respect of which the design is registered: **Spider fitting**
(51) International Design Classification: **06-06G**
(74) Name(s) of Attorney(s): **Griffith Hack**
(71) Name(s) and Address(s) of Applicant(s):
Fethers Glazing Systems Pty Ltd
75-77 Ricketts Rd Mt Waverley VIC 3149 Australia
(72) Name(s) of Designer(s): **Jonathan Bing Yan and Daniel Kuang-Chen Liu**
(45) Registration Date: **02 September 2015**
(56) Related Art Documents: **Not Applicable**
(57) Statement of Newness and Distinctiveness: **The shape and configuration of the product as shown by solid lines in the accompanying representations is new and distinctive.**

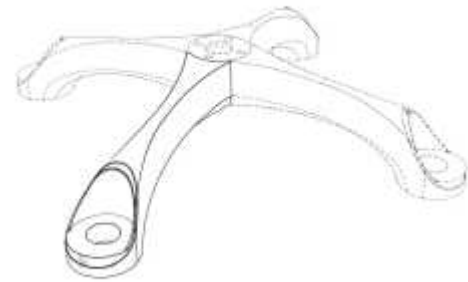

(21) Design Number: **14267/2015**
(22) Date of Filing Application: **19 August 2015**
(24) Date from which industrial property rights may have effect: **19 August 2015**
(54) Product in respect of which the design is registered: **Watch**
(51) International Design Classification: **10-02**
(74) Name(s) of Attorney(s): **WATERMARK PATENT AND TRADE MARKS ATTORNEYS**
(71) Name(s) and Address(s) of Applicant(s):
Swatch AG (Swatch SA) (Swatch Ltd.)
Jakob-Stampfli-Strasse 94 Biel/Bienne 2502 Switzerland
(72) Name(s) of Designer(s): **Alphonse Arellano Wuaka and Raphael Waecker and Min Kim**
(45) Registration Date: **02 September 2015**
(30) Convention priority data:
(31) Number (32) Date (33) Country
DM/086 421 23 Feb 2015 WORLD INTELLECTUAL PROPERTY ORGANIZATION (WIPO)
(56) Related Art Documents: **Not Applicable**
(57) Statement of Newness and Distinctiveness: **Nil**



(21) Design Number: **16154/2014**
(22) Date of Filing Application: **27 November 2014**
(24) Date from which industrial property rights may have effect: **27 November 2014**
(54) Product in respect of which the design is registered: **Cosmetic container**
(51) International Design Classification: **09-01G**
(74) Name(s) of Attorney(s): **Corrs Chambers Westgarth**
(71) Name(s) and Address(s) of Applicant(s):
Christian Louboutin
1 rue Volney Paris 75002 France
(72) Name(s) of Designer(s): **Carole Albertini**
(45) Registration Date: **02 September 2015**
(30) Convention priority data:
(31) Number (32) Date (33) Country
002475509 03 Jun 2014 OFFICE FOR HARMONISATION IN THE INTERNAL MARKET (OHIM)
(56) Related Art Documents: **Not Applicable**
(57) Statement of Newness and Distinctiveness: **Nil**



(21) Design Number: **16155/2014**
(22) Date of Filing Application: **27 November 2014**
(24) Date from which industrial property rights may have effect: **27 November 2014**
(54) Product in respect of which the design is registered: **Cosmetic container**
(51) International Design Classification: **09-01G**
(74) Name(s) of Attorney(s): **Corrs Chambers Westgarth**
(71) Name(s) and Address(s) of Applicant(s):
Christian Louboutin
1 rue Volney Paris 75002 France
(72) Name(s) of Designer(s): **Carole Albertini**
(45) Registration Date: **02 September 2015**
(30) Convention priority data:
(31) Number (32) Date (33) Country
002475509 03 Jun 2014 OFFICE FOR HARMONISATION IN
THE INTERNAL MARKET (OHIM)
(56) Related Art Documents: **Not Applicable**
(57) Statement of Newness and Distinctiveness: **Nil**



(21) Design Number: **16156/2014**
(22) Date of Filing Application: **27 November 2014**
(24) Date from which industrial property rights may have effect: **27 November 2014**
(54) Product in respect of which the design is registered: **Cosmetic container**
(51) International Design Classification: **09-01G**
(74) Name(s) of Attorney(s): **Corrs Chambers Westgarth**
(71) Name(s) and Address(s) of Applicant(s):
Christian Louboutin
1 rue Volney Paris 75002 France
(72) Name(s) of Designer(s): **Carole Albertini**
(45) Registration Date: **02 September 2015**
(30) Convention priority data:
(31) Number (32) Date (33) Country
002475509 03 Jun 2014 OFFICE FOR HARMONISATION IN
THE INTERNAL MARKET (OHIM)
(56) Related Art Documents: **Not Applicable**
(57) Statement of Newness and Distinctiveness: **Nil**



(19) AU

(21) Design Number: **12880/2015**
 (22) Date of Filing Application: **09 June 2015**
 (24) Date from which industrial property rights may have effect: **09 June 2015**
 (54) Product in respect of which the design is registered: **Catheter gripper aid**
 (51) International Design Classification: **24-04**
 (74) Name(s) of Attorney(s): **Shelston IP**
 (71) Name(s) and Address(s) of Applicant(s):
Hollister Incorporated
2000 Hollister Dr Libertyville Illinois 60048 United States of America
 (72) Name(s) of Designer(s): **Barbara J Kearns and David A Knauz**
 (45) Registration Date: **02 September 2015**
 (30) Convention priority data:
 (31) Number (32) Date (33) Country
29/511409 10 Dec 2014 UNITED STATES OF AMERICA
 (56) Related Art Documents: **Not Applicable**
 (57) Statement of Newness and Distinctiveness: **Newness and distinctiveness reside in the shape and/or configuration of a CATHERER GRIPPER AID as illustrated by solid lines in the accompanying representations.**

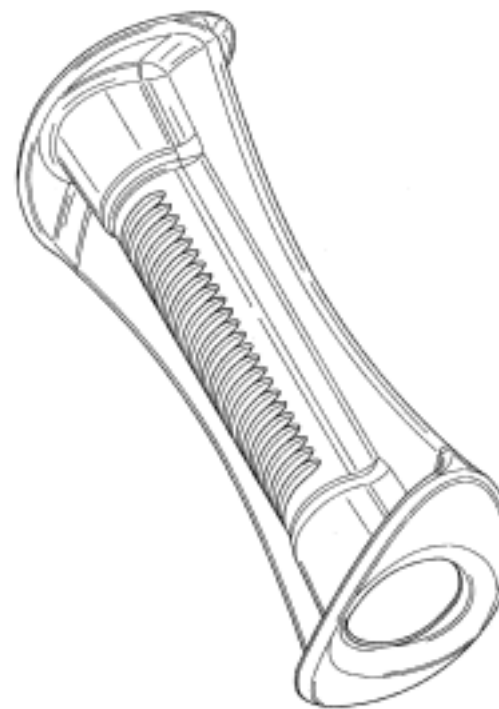

(19) AU

(21) Design Number: **13866/2015**
 (22) Date of Filing Application: **31 July 2015**
 (24) Date from which industrial property rights may have effect: **31 July 2015**
 (54) Product in respect of which the design is registered: **Ramp**
 (51) International Design Classification: **12-05**
 (74) Name(s) of Attorney(s): **Finlaysons**
 (71) Name(s) and Address(s) of Applicant(s):
Robby Gordon
10615 Twin Lakes Pkwy Charlotte NC, 28269 United States of America
 (72) Name(s) of Designer(s): **Robby Gordon**
 (45) Registration Date: **02 September 2015**
 (56) Related Art Documents: **Not Applicable**
 (57) Statement of Newness and Distinctiveness: **Nil**



- (21) Design Number: **13373/2015**
(22) Date of Filing Application: **03 July 2015**
(24) Date from which industrial property rights may have effect: **03 November 2014**
(54) Product in respect of which the design is registered: **Article of clothing**
(51) International Design Classification: **02-02C**
(74) Name(s) of Attorney(s): **Allens Patent & Trade Mark Attorneys**
(71) Name(s) and Address(s) of Applicant(s):
Forever New Clothing Pty Ltd
L4 Building 8 576 Swan St Richmond VIC 3121 Australia
(72) Name(s) of Designer(s): **Teagan McLeod**
(45) Registration Date: **02 September 2015**
(62) Divisional of: **362498**
(56) Related Art Documents: **Not Applicable**
(57) Statement of Newness and Distinctiveness: **Newness and distinctiveness resides in the visual features of shape, configuration, pattern and/or ornamentation of an article of clothing as shown in the accompanying representations.**



- (21) Design Number: **13376/2015**
(22) Date of Filing Application: **03 July 2015**
(24) Date from which industrial property rights may have effect: **03 November 2014**
(54) Product in respect of which the design is registered: **Article of clothing**
(51) International Design Classification: **02-02C**
(74) Name(s) of Attorney(s): **Allens Patent & Trade Mark Attorneys**
(71) Name(s) and Address(s) of Applicant(s):
Forever New Clothing Pty Ltd
L4 Bldg 8 576 Swan St Richmond VIC 3121 Australia
(72) Name(s) of Designer(s): **Teagan McLeod**
(45) Registration Date: **02 September 2015**
(62) Divisional of: **362498**
(56) Related Art Documents: **Not Applicable**
(57) Statement of Newness and Distinctiveness: **Newness and distinctiveness resides in the visual features of shape, configuration, pattern and/or ornamentation of an article of clothing as shown in the accompanying representations.**

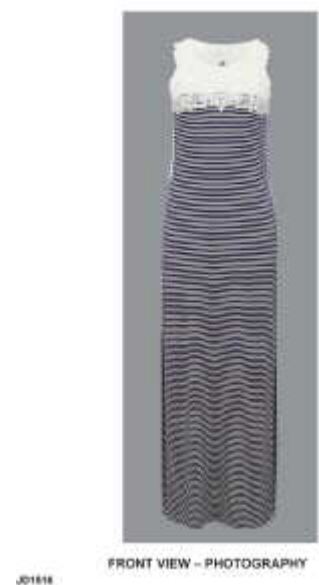

- (21) Design Number: **11551/2015**
(22) Date of Filing Application: **22 March 2015**
(24) Date from which industrial property rights may have effect: **22 March 2015**
(54) Product in respect of which the design is registered: **Socks**
(51) International Design Classification: **02-04C**
(74) Name(s) of Attorney(s):
(71) Name(s) and Address(s) of Applicant(s):
Catherine McNamara
PO Box 334 Torquay VIC 3228 Australia
(72) Name(s) of Designer(s): **Eva Chavez**
(45) Registration Date: **02 September 2015**
(56) Related Art Documents: **Not Applicable**
(57) Statement of Newness and Distinctiveness: **A white sock with red poppies on it. Also includes the words 100 years to commemorate the anniversary of the Anzacs.**



- (21) Design Number: **13370/2015**
(22) Date of Filing Application: **03 July 2015**
(24) Date from which industrial property rights may have effect: **03 November 2014**
(54) Product in respect of which the design is registered: **Article of clothing**
(51) International Design Classification: **02-02C**
(74) Name(s) of Attorney(s): **Allens Patent & Trade Mark Attorneys**
(71) Name(s) and Address(s) of Applicant(s):
Forever New Clothing Pty Ltd
L4 Building 8 576 Swan St Richmond VIC 3121 Australia
(72) Name(s) of Designer(s): **Gemma Henderson**
(45) Registration Date: **02 September 2015**
(62) Divisional of: **362498**
(56) Related Art Documents: **Not Applicable**
(57) Statement of Newness and Distinctiveness: **Newness and distinctiveness resides in the visual features of shape, configuration, pattern and/or ornamentation of an article of clothing as shown in the accompanying representations.**



(21) Design Number: **12870/2015**
(22) Date of Filing Application: **05 June 2015**
(24) Date from which industrial property rights may have effect: **05 June 2015**
(54) Product in respect of which the design is registered: **Container with tray**
(51) International Design Classification: **09-03NES**
(74) Name(s) of Attorney(s): **Fraser Old & Sohn**
(71) Name(s) and Address(s) of Applicant(s):
THE HERSHEY COMPANY
100 Crystal A Drive, HERSHEY PENNSYLVANIA 17033 United States of America

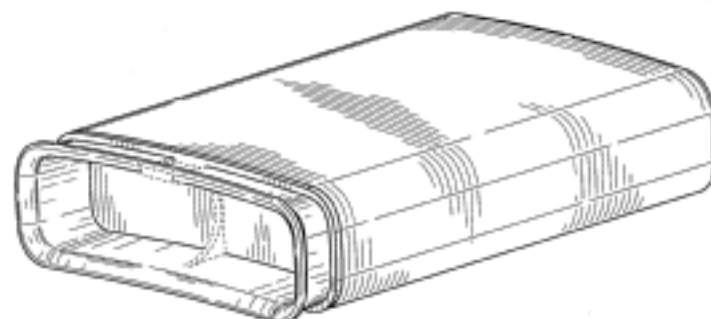

(72) Name(s) of Designer(s): **William J Hendricks and Eric P Lawrence and Jonathon K Markey and Michael J Van Driest**
(45) Registration Date: **03 September 2015**
(30) Convention priority data:
(31) Number (32) Date (33) Country
29/511,191 08 Dec 2014 UNITED STATES OF AMERICA

(56) Related Art Documents: **Not Applicable**
(57) Statement of Newness and Distinctiveness: **Newness and distinctiveness is claimed in respect of the shape and/or configuration of the container having a tray, the container being as illustrated in the accompanying representations. In carrying out a consideration in accordance with Section 19 the shape and/or configuration of the tray illustrated in broken lines in the representations is/are not to be considered either new or distinctive and do/does not form part of the design.**

(21) Design Number: **12123/2015**
(22) Date of Filing Application: **23 April 2015**
(24) Date from which industrial property rights may have effect: **23 April 2015**
(54) Product in respect of which the design is registered: **Curved tissue fastening device**
(51) International Design Classification: **24-02**
(74) Name(s) of Attorney(s): **Callinans**
(71) Name(s) and Address(s) of Applicant(s):
ETHICON, INC.
U.S. Route 22 P.O. Box 151 Somerville, New Jersey, 08876 United States of America



(72) Name(s) of Designer(s): **Robert Nering**
(45) Registration Date: **03 September 2015**
(30) Convention priority data:
(31) Number (32) Date (33) Country
29/509958 24 Nov 2014 UNITED STATES OF AMERICA

(56) Related Art Documents: **Not Applicable**
(57) Statement of Newness and Distinctiveness: **Nil**

- (21) Design Number: **13587/2015**
(22) Date of Filing Application: **20 July 2015**
(24) Date from which industrial property rights may have effect: **20 July 2015**
(54) Product in respect of which the design is registered: **Toilet**
(51) International Design Classification: **23-02C**
(74) Name(s) of Attorney(s):
(71) Name(s) and Address(s) of Applicant(s):
BATHWARE BARGAINS PTY. LTD.
12 Salerwong PI Ryde NSW 2112 Australia
(72) Name(s) of Designer(s): **Sai Hui Tan**
(45) Registration Date: **03 September 2015**
(56) Related Art Documents: **Not Applicable**
(57) Statement of Newness and Distinctiveness: **Slim-line cistern classic round easy clean bowl**



- (21) Design Number: **13588/2015**
(22) Date of Filing Application: **20 July 2015**
(24) Date from which industrial property rights may have effect: **20 July 2015**
(54) Product in respect of which the design is registered: **Toilet suites**
(51) International Design Classification: **23-02C**
(74) Name(s) of Attorney(s):
(71) Name(s) and Address(s) of Applicant(s):
BATHWARE BARGAINS PTY. LTD.
12 Salerwong PI Ryde NSW 2112 Australia
(72) Name(s) of Designer(s): **Sai Hui Tan**
(45) Registration Date: **03 September 2015**
(56) Related Art Documents: **Not Applicable**
(57) Statement of Newness and Distinctiveness: **Slim-line cistern easy height elegant bowl**



(21) Design Number: **14281/2015**
(22) Date of Filing Application: **20 August 2015**
(24) Date from which industrial property rights may have effect: **20 August 2015**
(54) Product in respect of which the design is registered: **Package for ostomy flange extenders**
(51) International Design Classification: **09-05**
(74) Name(s) of Attorney(s): **PHILLIPS ORMONDE FITZPATRICK**
(71) Name(s) and Address(s) of Applicant(s):
Hollister Incorporated
2000 Hollister Drive Libertyville Illinois 60048 United States of America
(72) Name(s) of Designer(s): **Anthony Scalise and Naja Dahl and Dion A. Jackson and Donald Rakevicius and Glenn Warning and Amy Wheaton and Scott Jachimski**
(45) Registration Date: **03 September 2015**
(30) Convention priority data:
(31) Number (32) Date (33) Country
29/519,709 06 Mar 2015 UNITED STATES OF AMERICA
(56) Related Art Documents: **Not Applicable**
(57) Statement of Newness and Distinctiveness: **Nil**

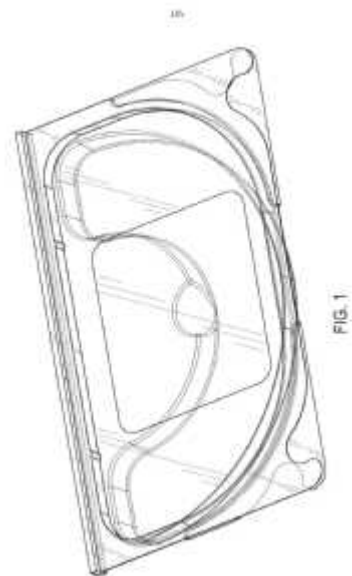

(21) Design Number: **14135/2015**
(22) Date of Filing Application: **12 August 2015**
(24) Date from which industrial property rights may have effect: **12 August 2015**
(54) Product in respect of which the design is registered: **Pacifier**
(51) International Design Classification: **24-04**
(74) Name(s) of Attorney(s): **FB Rice**
(71) Name(s) and Address(s) of Applicant(s):
Koninklijke Philips N.V.
High Tech Campus 5 5656 AE Eindhoven The Netherlands
(72) Name(s) of Designer(s): **Jason Eaton and Ron Roth**
(45) Registration Date: **07 September 2015**
(56) Related Art Documents: **Not Applicable**
(57) Statement of Newness and Distinctiveness: **Newness and distinctiveness reside in the features of shape and configuration of the design as shown in the representations.**



(21) Design Number: **13328/2015**
(22) Date of Filing Application: **02 July 2015**
(24) Date from which industrial property rights may have effect: **20 October 2014**
(54) Product in respect of which the design is registered: **Headworn electronic device**
(51) International Design Classification: **14-02**
(74) Name(s) of Attorney(s): **Freehills Patent Attorneys**
(71) Name(s) and Address(s) of Applicant(s):
AutoCoach Pty Ltd
SE 1508 1 Queens Rd Melbourne VIC 3004 Australia
(72) Name(s) of Designer(s): **Dean Sharples**
(45) Registration Date: **07 September 2015**
(62) Divisional of: **362497**
(56) Related Art Documents: **Not Applicable**
(57) Statement of Newness and Distinctiveness: **Nil**

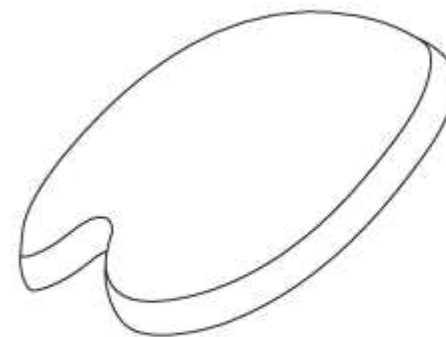

(21) Design Number: **13855/2015**
(22) Date of Filing Application: **30 July 2015**
(24) Date from which industrial property rights may have effect: **30 July 2015**
(54) Product in respect of which the design is registered: **Packaging container**
(51) International Design Classification: **09-03M**
(74) Name(s) of Attorney(s): **IP Gateway Patent & Trade Mark Attorneys Pty Ltd**
(71) Name(s) and Address(s) of Applicant(s):
Caroline Shelverton
133 Cedar Creek Rd Upper Kedron QLD 4055 Australia
(72) Name(s) of Designer(s): **Caroline Shelverton**
(45) Registration Date: **07 September 2015**
(56) Related Art Documents: **Not Applicable**
(57) Statement of Newness and Distinctiveness: **Newness and distinctiveness resides in visual features of shape and configuration as shown in the accompanying representations. The dashed lines shown in the side views with open configuration are shown for environmental purposes only to schematically represent any internal contents. The overall proportions of length, depth and height of the packaging container are to be given minimum emphasis when considering newness and distinctiveness.**

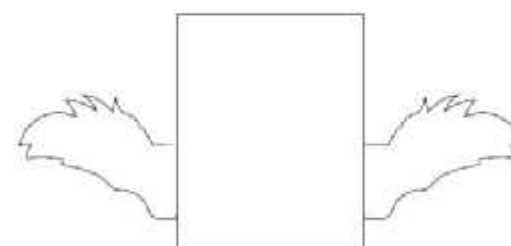

(21) Design Number: **14303/2015**
(22) Date of Filing Application: **21 August 2015**
(24) Date from which industrial property rights may have effect: **21 August 2015**
(54) Product in respect of which the design is registered: **Food container with handle**
(51) International Design Classification: **09-03M**
(74) Name(s) of Attorney(s): **PHILLIPS ORMONDE FITZPATRICK**
(71) Name(s) and Address(s) of Applicant(s):
Dart Industries Inc.
14901 S. Orange Blossom Trail Orlando Florida, 32837 United States of America
(72) Name(s) of Designer(s): **James Michael Wiggins**
(45) Registration Date: **07 September 2015**
(30) Convention priority data:
(31) Number (32) Date (33) Country
29/520,706 17 Mar 2015 UNITED STATES OF AMERICA
(56) Related Art Documents: **Not Applicable**
(57) Statement of Newness and Distinctiveness: **Those features of the food container with handle depicted in the representations that are new and distinctive are the shape and/or configuration.**

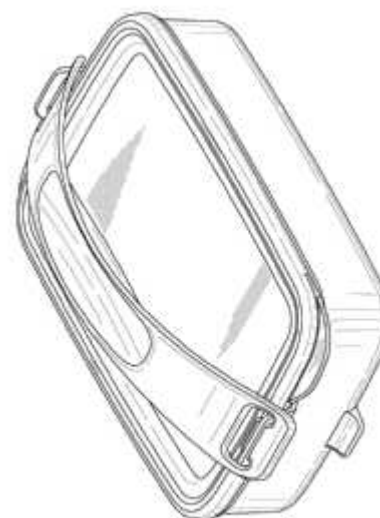

(21) Design Number: **14304/2015**
(22) Date of Filing Application: **21 August 2015**
(24) Date from which industrial property rights may have effect: **21 August 2015**
(54) Product in respect of which the design is registered: **Combined punching bag and heavy bag**
(51) International Design Classification: **21-02NES**
(74) Name(s) of Attorney(s): **Ascot Martin Registered Patent & Trade Mark Attorneys**
(71) Name(s) and Address(s) of Applicant(s):
Christopher Lazar
8 Setrop Ave Elizabeth Hills NSW 2171 Australia
(72) Name(s) of Designer(s): **Christopher Lazar**
(45) Registration Date: **07 September 2015**
(56) Related Art Documents: **Not Applicable**
(57) Statement of Newness and Distinctiveness: **The features of the design that are new and distinctive are the shape and configuration of the combined punching bag and heavy bag as shown in the accompanying representations that include shading lines.**

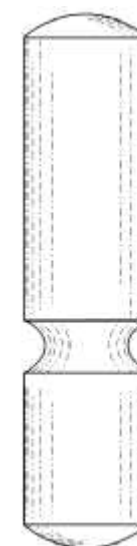

- (21) Design Number: **14310/2015**
(22) Date of Filing Application: **21 August 2015**
(24) Date from which industrial property rights may have effect: **21 August 2015**
(54) Product in respect of which the design is registered: **A wheel assembly**
(51) International Design Classification: **15-03B**
(74) Name(s) of Attorney(s):
(71) Name(s) and Address(s) of Applicant(s):
Technology Assisting Disability WA Inc (TADWA)
371 Collier Rd Bassendean WA 6054 Australia
(72) Name(s) of Designer(s): **Brad Fortune and John Otago**
(45) Registration Date: **07 September 2015**
(56) Related Art Documents: **Not Applicable**
(57) Statement of Newness and Distinctiveness: **The design relates to the overall appearance and particular visual features of a product, being a wheel assembly, having the pattern, shape, configuration or ornamentation as shown in the accompanying representations.**

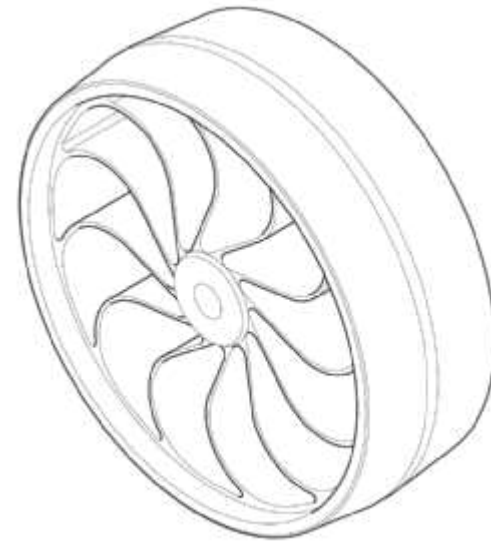

- (21) Design Number: **14311/2015**
(22) Date of Filing Application: **21 August 2015**
(24) Date from which industrial property rights may have effect: **21 August 2015**
(54) Product in respect of which the design is registered: **A receptacle**
(51) International Design Classification: **24-01**
(74) Name(s) of Attorney(s): **Chrysiliou IP**
(71) Name(s) and Address(s) of Applicant(s):
Multigate Medical Products Pty Limited
27 Llewellyn Ave Villawood NSW 2163 Australia
(72) Name(s) of Designer(s): **Ben Chen**
(45) Registration Date: **07 September 2015**
(56) Related Art Documents: **Not Applicable**
(57) Statement of Newness and Distinctiveness: **Nil**



(21) Design Number: **14315/2015**

(22) Date of Filing Application: **22 August 2015**

(24) Date from which industrial property rights may have effect: **22 August 2015**

(54) Product in respect of which the design is registered: **Food slicer**

(51) International Design Classification: **07-04**

(74) Name(s) of Attorney(s): **John Christiansen**

(71) Name(s) and Address(s) of Applicant(s):

**Smith's Consumer Products, Inc.
747 Mid-America Boulevard Hot Springs Arkansas 71913 United States
of America**

(72) Name(s) of Designer(s): **Richard S Smith and Louis Chalfant**

(45) Registration Date: **07 September 2015**

(30) Convention priority data:

(31) Number	(32) Date	(33) Country
29/518,379	23 Feb 2015	UNITED STATES OF AMERICA

(56) Related Art Documents: **Not Applicable**

(57) Statement of Newness and Distinctiveness: **Newness and distinctiveness is claimed in the visual features of a food slicer shown in the representations. FIG. 1 is a front perspective view; FIG. 2 is a front elevational view; FIG. 3 is a rear elevational view FIG. 4 is a side elevational view; FIG. 5 is a opposite side elevational view; FIG. 6 is a bottom plan view; FIG 7 is a top plan view; FIG. 8 is a front perspective view of the slicer with the lid open; FIG. 9 is a front perspective view of the slicer element of the food slicer, removed from the food slicer Fig.1; FIG. 10 is a front elevational view of the slicer element; FIG. 11 is a rear elevational view of the slicer element; FIG. 12 is a side elevational view of the slicer element; FIG. 13 is an opposite side elevational view of the slicer element; 2 FIG. 14 is a top plan view of the slicer element; FIG 15 is a bottom plan view of the slicer element; and FIG. 16 is a side elevational view of the food slicer with the lid in a raised position.**

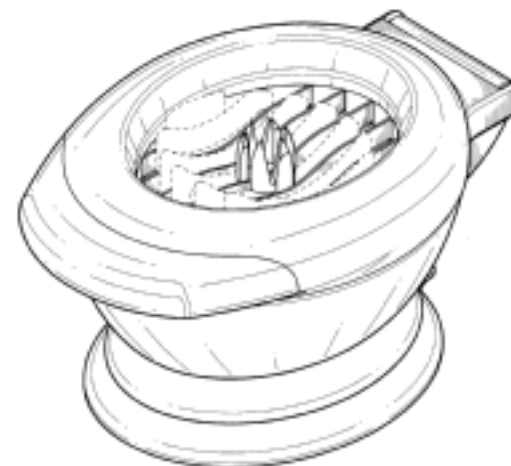

(21) Design Number: **14316/2015**

(22) Date of Filing Application: **22 August 2015**

(24) Date from which industrial property rights may have effect: **22 August 2015**

(54) Product in respect of which the design is registered: **Bottle**

(51) International Design Classification: **09-01K**

(74) Name(s) of Attorney(s):

(71) Name(s) and Address(s) of Applicant(s):

**Variant Technology Ptd Ltd
PO BOX 174 Vermont VIC 3133 Australia**

(72) Name(s) of Designer(s): **Matthew Gabelich**

(45) Registration Date: **07 September 2015**

(56) Related Art Documents: **Not Applicable**

(57) Statement of Newness and Distinctiveness: **Newness and distinctiveness resides in the shape and configuration of a bottle as depicted in the accompanying photograph. The text appearing on the bottle does not form part of the design.**



(21) Design Number: **14318/2015**
(22) Date of Filing Application: **23 August 2015**
(24) Date from which industrial property rights may have effect: **23 August 2015**
(54) Product in respect of which the design is registered: **Plant holder**
(51) International Design Classification: **11-02B**
(74) Name(s) of Attorney(s):
(71) Name(s) and Address(s) of Applicant(s):
Travis Blandford
PO BOX 254 Seddon West VIC 3011 Australia
(72) Name(s) of Designer(s): **Travis Blandford**
(45) Registration Date: **07 September 2015**
(56) Related Art Documents: **Not Applicable**
(57) Statement of Newness and Distinctiveness: **Newness: Expandable plant holder with supporting rivet/rod for plastic plant pot Distinctiveness: Cylindrical plant holder with 1 open side, rounded/radius edges and expressed rivet(s).**

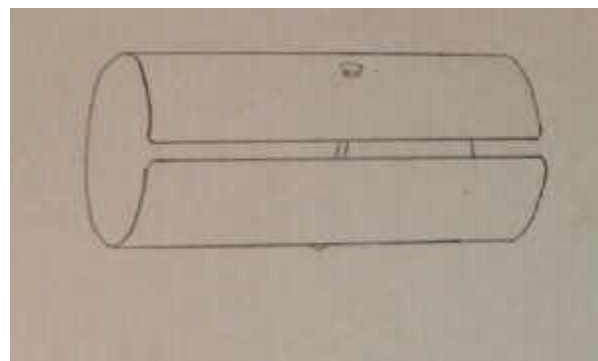

(21) Design Number: **13537/2015**
(22) Date of Filing Application: **15 July 2015**
(24) Date from which industrial property rights may have effect: **15 July 2015**
(54) Product in respect of which the design is registered: **Sandwich spreader**
(51) International Design Classification: **07-03**
(74) Name(s) of Attorney(s): **PHILLIPS ORMONDE FITZPATRICK**
(71) Name(s) and Address(s) of Applicant(s):
Dart Industries Inc.
14901 S. Orange Blossom Trail Orlando Florida, 32837 United States of America
(72) Name(s) of Designer(s): **Sara L. Delgado Carmona**
(45) Registration Date: **07 September 2015**
(30) Convention priority data:
(31) Number (32) Date (33) Country
29/516,487 03 Feb 2015 UNITED STATES OF AMERICA
(56) Related Art Documents: **Not Applicable**
(57) Statement of Newness and Distinctiveness: **Those features of the sandwich spreader depicted in the representations that are new and distinctive are the shape and/or configuration. The stipple shown in Figs 8-14 illustrates a surface texture that is different from the non-stipple areas.**

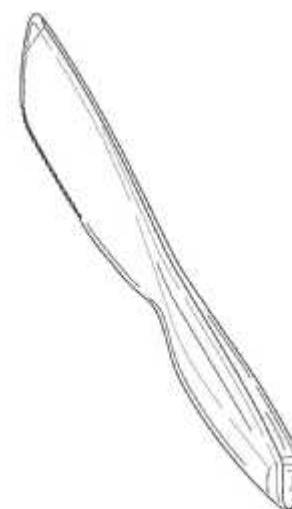

- (21) Design Number: **14142/2015**
(22) Date of Filing Application: **13 August 2015**
(24) Date from which industrial property rights may have effect: **13 August 2015**
(54) Product in respect of which the design is registered: **Bobble head doll figurine**
(51) International Design Classification: **21-01A**
(74) Name(s) of Attorney(s):
(71) Name(s) and Address(s) of Applicant(s):
ROCKIN ROOS PTY LTD
19 Roden St Keppel Sands QLD 4702 Australia
(72) Name(s) of Designer(s): **Samantha Morris and Peter Morris**
(45) Registration Date: **07 September 2015**
(56) Related Art Documents: **Not Applicable**
(57) Statement of Newness and Distinctiveness: **Characters newness and distinctiveness includes Hair, hands with fingers, clothing, large eyes and nose, wide and long curvature to the tail, shoes instead of feet, head proportion larger in comparison to a real image of a kangaroo.**



- (21) Design Number: **14143/2015**
(22) Date of Filing Application: **13 August 2015**
(24) Date from which industrial property rights may have effect: **13 August 2015**
(54) Product in respect of which the design is registered: **Bobble head doll figurine**
(51) International Design Classification: **21-01A**
(74) Name(s) of Attorney(s):
(71) Name(s) and Address(s) of Applicant(s):
ROCKIN ROOS PTY LTD
19 Roden St Keppel Sands QLD 4702 Australia
(72) Name(s) of Designer(s): **Samantha Morris and Peter Morris**
(45) Registration Date: **07 September 2015**
(56) Related Art Documents: **Not Applicable**
(57) Statement of Newness and Distinctiveness: **Newness and distinctiveness of visual appearance of figurine include clothing, thongs, hat, larger nose and eyes with a larger proportional head. fingers used to hold ball and can. Wider curvature of the tail and length. Wide stance. Wide smile.**



- (21) Design Number: **14144/2015**
(22) Date of Filing Application: **13 August 2015**
(24) Date from which industrial property rights may have effect: **13 August 2015**
(54) Product in respect of which the design is registered: **Bobble head doll figurine**
(51) International Design Classification: **21-01A**
(74) Name(s) of Attorney(s):
(71) Name(s) and Address(s) of Applicant(s):
ROCKIN ROOS PTY LTD
19 Roden St Keppel Sands QLD 4702 Australia
(72) Name(s) of Designer(s): **Samantha Morris and Peter Morris**
(45) Registration Date: **07 September 2015**
(56) Related Art Documents: **Not Applicable**
(57) Statement of Newness and Distinctiveness: **Newness and Distinctiveness of figurine include addition of an akubra hat, horsemans saddle and whip, the character is wearing a stockmans jacket along with spurs and boots. His facial features include larger eyes and a longer / broader nose to give a fun/comic appearance unlike a real kangaroo. The curve of the tail and width of the legs provide a stand for the character. The two most distinctive features would be the major changes to the face look and size along with the clothing the character is dressed in.**



- (21) Design Number: **13063/2015**
(22) Date of Filing Application: **17 June 2015**
(24) Date from which industrial property rights may have effect: **17 June 2015**
(54) Product in respect of which the design is registered: **Flexible dispensing container**
(51) International Design Classification: **09-01NES**
(74) Name(s) of Attorney(s): **Davies Collison Cave**
(71) Name(s) and Address(s) of Applicant(s):
Kmart Australia Limited
L3 690 Springvale Rd Mulgrave VIC 3170 Australia
(72) Name(s) of Designer(s): **Jo Louder and Siri Thanissorn**
(45) Registration Date: **07 September 2015**
(56) Related Art Documents: **Not Applicable**
(57) Statement of Newness and Distinctiveness: **Newness and distinctiveness is claimed in the features of shape and configuration of the flexible dispensing container shown in the representations, disregarding the cap. Shading is provided for illustrative purposes and does not form part of the design.**



- (21) Design Number: **11130/2015**
(22) Date of Filing Application: **02 March 2015**
(24) Date from which industrial property rights may have effect: **02 March 2015**
(54) Product in respect of which the design is registered: **Instrument panel for an automobile**
(51) International Design Classification: **12-16NES**
(74) Name(s) of Attorney(s): **Spruson & Ferguson**
(71) Name(s) and Address(s) of Applicant(s):
Toyota Jidosha Kabushiki Kaisha
1, Toyota-cho, Toyota-shi, Aichi-ken 471-8571 Japan
(72) Name(s) of Designer(s): **Mitsunori Kakihata and Hidemasa Komatsu**
(45) Registration Date: **07 September 2015**
(56) Related Art Documents: **Not Applicable**
(57) Statement of Newness and Distinctiveness: **Newness and distinctiveness is claimed in the features of shape and/or configuration of an instrument panel for an automobile as illustrated in the accompanying representations.**



- (21) Design Number: **11133/2015**
(22) Date of Filing Application: **02 March 2015**
(24) Date from which industrial property rights may have effect: **02 March 2015**
(54) Product in respect of which the design is registered: **Automobile**
(51) International Design Classification: **12-08**
(74) Name(s) of Attorney(s): **Spruson & Ferguson**
(71) Name(s) and Address(s) of Applicant(s):
Toyota Jidosha Kabushiki Kaisha
1, Toyota-cho, Toyota-shi, Aichi-ken 471-8571 Japan
(72) Name(s) of Designer(s): **Makoto Takahashi and Satoshi Okamoto**
(45) Registration Date: **07 September 2015**
(56) Related Art Documents: **Not Applicable**
(57) Statement of Newness and Distinctiveness: **Newness and distinctiveness is claimed in those features of the shape and/or configuration of an automobile that are illustrated in dense colours in the additional views of the accompanying representations, apart from Toyota emblems.**



- (21) Design Number: **11278/2015**
(22) Date of Filing Application: **06 March 2015**
(24) Date from which industrial property rights may have effect: **06 March 2015**
(54) Product in respect of which the design is registered: **Pipe access fitting**
(51) International Design Classification: **23-01A**
(74) Name(s) of Attorney(s): **PHILLIPS ORMONDE FITZPATRICK**
(71) Name(s) and Address(s) of Applicant(s):
Aymroo Pty Ltd
PO BOX 5182 Minto BC NSW 2566 Australia
(72) Name(s) of Designer(s): **Owen Edward Luke and Joel Colin Leaves**
(45) Registration Date: **07 September 2015**
(56) Related Art Documents: **Not Applicable**
(57) Statement of Newness and Distinctiveness: **Nil**



- (21) Design Number: **13270/2015**
(22) Date of Filing Application: **29 June 2015**
(24) Date from which industrial property rights may have effect: **10 April 2015**
(54) Product in respect of which the design is registered: **Bottle**
(51) International Design Classification: **09-01NES**
(74) Name(s) of Attorney(s): **Ashurst Australia**
(71) Name(s) and Address(s) of Applicant(s):
Coca-Cola Amatil (Aust) Pty Ltd
Level 14 40 Mount Street North Sydney New South Wales 2060 Australia
(72) Name(s) of Designer(s): **Arnie Grainger**
(45) Registration Date: **07 September 2015**
(62) Divisional of: **362445**
(56) Related Art Documents: **Not Applicable**
(57) Statement of Newness and Distinctiveness: **Newness and distinctiveness is shown in the features of shape and configuration showing in solid lines in the accompanying representations.**

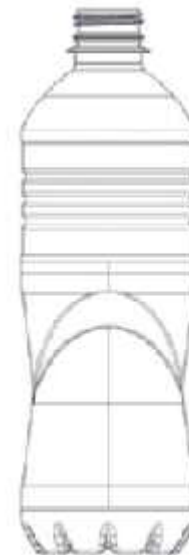

(21) Design Number: **13982/2015**
(22) Date of Filing Application: **05 August 2015**
(24) Date from which industrial property rights may have effect: **05 August 2015**
(54) Product in respect of which the design is registered: **Cover for an electronic device**
(51) International Design Classification: **03-01NES**
(74) Name(s) of Attorney(s): **Griffith Hack**
(71) Name(s) and Address(s) of Applicant(s):
Urban Armor Gear, LLC
28202 Cabot Road, Suite 300 Laguna Niguel, California, 92677 United States of America
(72) Name(s) of Designer(s): **Steven Armstrong and Jay Veltz**
(45) Registration Date: **07 September 2015**
(30) Convention priority data:
(31) Number (32) Date (33) Country
29/517,024 09 Feb 2015 UNITED STATES OF AMERICA
(56) Related Art Documents: **Not Applicable**
(57) Statement of Newness and Distinctiveness: **Newness and distinctiveness resides in the visual features, including the shape and configuration of the product shown by means of the solid lines in the representations. Those parts shown by means of dashed lines have been included for illustrative purposes.**

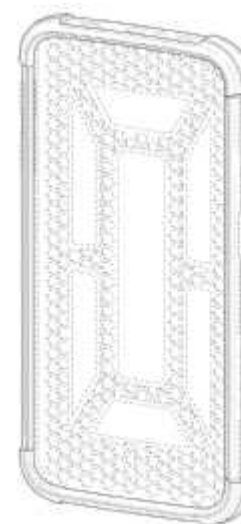

(21) Design Number: **14206/2015**
(22) Date of Filing Application: **17 August 2015**
(24) Date from which industrial property rights may have effect: **17 August 2015**
(54) Product in respect of which the design is registered: **A desk**
(51) International Design Classification: **06-03C**
(74) Name(s) of Attorney(s): **Fraser Old & Sohn**
(71) Name(s) and Address(s) of Applicant(s):
VARIDESK, LLC
117 Wrangler Drive Coppell, Texas, 75019 United States of America
(72) Name(s) of Designer(s): **Daniel G Flaherty and David Patton**
(45) Registration Date: **07 September 2015**
(30) Convention priority data:
(31) Number (32) Date (33) Country
29/533490 17 Jul 2015 UNITED STATES OF AMERICA
(56) Related Art Documents: **Not Applicable**
(57) Statement of Newness and Distinctiveness: **Newness and distinctiveness is claimed in respect of the shape and/or configuration of the desk illustrated in Figs. 1-7 of the accompanying representations. In carrying out a consideration in accordance with Section 19 the shape and/or configuration of the portions illustrated by broken lines in Figs. 1-7 of the representations do/does not form part of the design. Appendices 1.1 - 1.7 reproduce Figs. 1-7 respectively but with the portions illustrated by broken lines being illustrated in solid lines.**

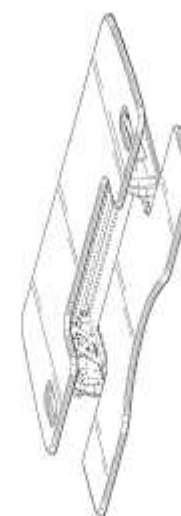

(21) Design Number: **14271/2015**

(22) Date of Filing Application: **20 August 2015**

(24) Date from which industrial property rights may have effect: **20 August 2015**

(54) Product in respect of which the design is registered: **Slim double power point**

(51) International Design Classification: **13-03D**

(74) Name(s) of Attorney(s):

(71) Name(s) and Address(s) of Applicant(s):

AUSWITCH PTY LTD

5 Waratah Ave Casula NSW 2170 Australia

(72) Name(s) of Designer(s): **Bilal Elakde**

(45) Registration Date: **07 September 2015**

(56) Related Art Documents: **Not Applicable**

(57) Statement of Newness and Distinctiveness: **Nil**



(21) Design Number: **14272/2015**

(22) Date of Filing Application: **20 August 2015**

(24) Date from which industrial property rights may have effect: **20 August 2015**

(54) Product in respect of which the design is registered: **Standard double power point**

(51) International Design Classification: **13-03D**

(74) Name(s) of Attorney(s):

(71) Name(s) and Address(s) of Applicant(s):

AUSWITCH PTY LTD

5 Waratah Ave Casula NSW 2170 Australia

(72) Name(s) of Designer(s): **Bilal Elakde**

(45) Registration Date: **07 September 2015**

(56) Related Art Documents: **Not Applicable**

(57) Statement of Newness and Distinctiveness: **il**



(21) Design Number: **14299/2015**
(22) Date of Filing Application: **21 August 2015**
(24) Date from which industrial property rights may have effect: **21 August 2015**
(54) Product in respect of which the design is registered: **Container with stacking tabs**
(51) International Design Classification: **09-03M**
(74) Name(s) of Attorney(s): **PHILLIPS ORMONDE FITZPATRICK**
(71) Name(s) and Address(s) of Applicant(s):
Dart Industries Inc.
14901 S. Orange Blossom Trail Orlando Florida, 32837 United States of America
(72) Name(s) of Designer(s): **James Michael Wiggins**
(45) Registration Date: **07 September 2015**
(30) Convention priority data:
(31) Number (32) Date (33) Country
29/520,688 17 Mar 2015 UNITED STATES OF AMERICA
(56) Related Art Documents: **Not Applicable**
(57) Statement of Newness and Distinctiveness: **Those features of the container with stacking tabs depicted in the representations that are new and distinctive are the shape and/or configuration.**

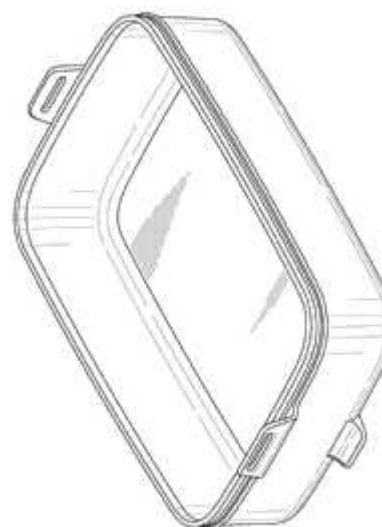

(21) Design Number: **14300/2015**
(22) Date of Filing Application: **21 August 2015**
(24) Date from which industrial property rights may have effect: **21 August 2015**
(54) Product in respect of which the design is registered: **Earphone**
(51) International Design Classification: **14-01**
(74) Name(s) of Attorney(s): **FB Rice**
(71) Name(s) and Address(s) of Applicant(s):
LG Electronics Inc.
128, Yeoui-daero, Yeongdeungpo-gu Seoul 150-721 Republic of Korea
(72) Name(s) of Designer(s): **Heeju Chang and Hyon Kim**
(45) Registration Date: **07 September 2015**
(30) Convention priority data:
(31) Number (32) Date (33) Country
30-2015-0009656 25 Feb 2015 REPUBLIC OF KOREA
(56) Related Art Documents: **Not Applicable**
(57) Statement of Newness and Distinctiveness: **Newness and distinctiveness reside in the features of the design as shown in the representations.**



(21) Design Number: **14301/2015**

(22) Date of Filing Application: **21 August 2015**

(24) Date from which industrial property rights may have effect: **21 August 2015**

(54) Product in respect of which the design is registered: **Container seal with tabs**

(51) International Design Classification: **09-07B**

(74) Name(s) of Attorney(s): **PHILLIPS ORMONDE FITZPATRICK**

(71) Name(s) and Address(s) of Applicant(s):

Dart Industries Inc.

14901 S. Orange Blossom Trail Orlando Florida, 32837 United States of America

(72) Name(s) of Designer(s): **James Michael Wiggins**

(45) Registration Date: **07 September 2015**

(30) Convention priority data:

(31) Number	(32) Date	(33) Country
29/520,691	17 Mar 2015	UNITED STATES OF AMERICA

(56) Related Art Documents: **Not Applicable**

(57) Statement of Newness and Distinctiveness: **Those features of the container seal with tabs depicted in the representations that are new and distinctive are the shape and/or configuration.**



(21) Design Number: **14302/2015**

(22) Date of Filing Application: **21 August 2015**

(24) Date from which industrial property rights may have effect: **21 August 2015**

(54) Product in respect of which the design is registered: **Detachable container handle**

(51) International Design Classification: **07-02R**

(74) Name(s) of Attorney(s): **PHILLIPS ORMONDE FITZPATRICK**

(71) Name(s) and Address(s) of Applicant(s):

Dart Industries Inc.

14901 S. Orange Blossom Trail Orlando Florida, 32837 United States of America

(72) Name(s) of Designer(s): **James Michael Wiggins**

(45) Registration Date: **07 September 2015**

(30) Convention priority data:

(31) Number	(32) Date	(33) Country
29/520,704	17 Mar 2015	UNITED STATES OF AMERICA

(56) Related Art Documents: **Not Applicable**

(57) Statement of Newness and Distinctiveness: **Those features of the detachable container handle depicted in the representations that are new and distinctive are the shape and/or configuration.**

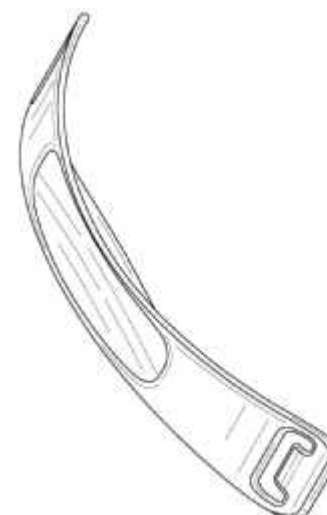

- (21) Design Number: **14320/2015**
(22) Date of Filing Application: **24 August 2015**
(24) Date from which industrial property rights may have effect: **24 August 2015**
(54) Product in respect of which the design is registered: **Handrail hinge**
(51) International Design Classification: **08-06**
(74) Name(s) of Attorney(s): **Armour IP**
(71) Name(s) and Address(s) of Applicant(s):
Bend-tech Investments 1 Pty Ltd
573 Bickley Rd Maddington WA 6109 Australia
(72) Name(s) of Designer(s): **Maria Lapchev**
(45) Registration Date: **07 September 2015**
(56) Related Art Documents: **Not Applicable**
(57) Statement of Newness and Distinctiveness: **Newness and distinctiveness resides in the shape and configuration of a handrail hinge as shown in the drawings, particularly with reference to the 'keyhole' cutout in the lower piece, and the shape of the upper rim of that piece. The shape of the connection between hinge pieces and tubular hand rails is not considered part of the design.**



- (21) Design Number: **14348/2015**
(22) Date of Filing Application: **24 August 2015**
(24) Date from which industrial property rights may have effect: **24 August 2015**
(54) Product in respect of which the design is registered: **Alu' plastic chair**
(51) International Design Classification: **06-01F**
(74) Name(s) of Attorney(s):
(71) Name(s) and Address(s) of Applicant(s):
Xuan Zhou
Tianhe District, Guangzhou Unit 704, Xin Chuang Ju Building, No.123
China
Guangzhou Gardenart Furniture Co., Ltd
Unit 704, No.123 Ti Yu Xi Road Tianhe District Guangzhou 510620 China
(72) Name(s) of Designer(s): **Jianhui Cao**
(45) Registration Date: **08 September 2015**
(56) Related Art Documents: **Not Applicable**
(57) Statement of Newness and Distinctiveness: **Nil**



(21) Design Number: **14370/2015**
(22) Date of Filing Application: **25 August 2015**
(24) Date from which industrial property rights may have effect: **25 August 2015**
(54) Product in respect of which the design is registered: **TV receiver with graphical user interface**
(51) International Design Classification: **14-03B**
(74) Name(s) of Attorney(s): **FB Rice**
(71) Name(s) and Address(s) of Applicant(s):
LG Electronics Inc.
128, Yeoui-daero, Yeongdeungpo-gu Seoul 07336 Korea
(72) Name(s) of Designer(s): **Kim Uniyong and Goeun Lee and Ryunghwa Rhee**
(45) Registration Date: **08 September 2015**
(30) Convention priority data:
(31) Number (32) Date (33) Country
30-2015-0009563 25 Feb 2015 REPUBLIC OF KOREA
(56) Related Art Documents: **Not Applicable**
(57) Statement of Newness and Distinctiveness: **Newness and distinctiveness reside in the features of pattern and/or ornamentation of a display screen with graphical user interface as illustrated by solid lines in the accompanying representation. The features shown in broken outline are for contextual purposes only and do not form part of the design.**

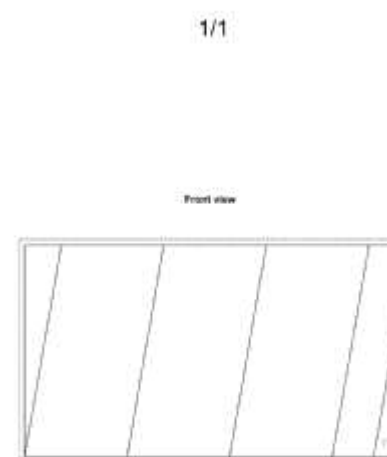

(21) Design Number: **14371/2015**
(22) Date of Filing Application: **25 August 2015**
(24) Date from which industrial property rights may have effect: **25 August 2015**
(54) Product in respect of which the design is registered: **TV receiver with graphical user interface**
(51) International Design Classification: **14-03B**
(74) Name(s) of Attorney(s): **FB Rice**
(71) Name(s) and Address(s) of Applicant(s):
LG Electronics Inc.
128, Yeoui-daero, Yeongdeungpo-gu Seoul 07336 Korea
(72) Name(s) of Designer(s): **Kunsik Lee and Kim Uniyong and Goeun Lee and Ryunghwa Rhee**
(45) Registration Date: **08 September 2015**
(30) Convention priority data:
(31) Number (32) Date (33) Country
30-2015-0009565 25 Feb 2015 REPUBLIC OF KOREA
(56) Related Art Documents: **Not Applicable**
(57) Statement of Newness and Distinctiveness: **Newness and distinctiveness reside in the features of pattern and/or ornamentation of a display screen with graphical user interface as illustrated by solid lines in the accompanying representation. The features shown in broken outline are for contextual purposes only and do not form part of the design.**

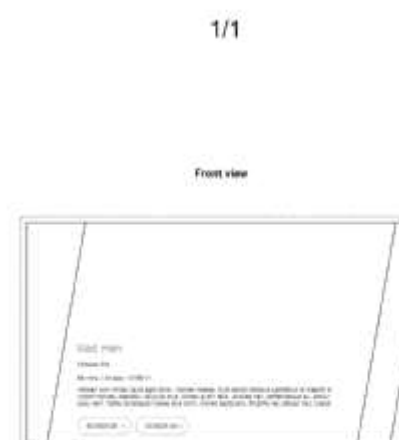

- (21) Design Number: **14375/2015**
(22) Date of Filing Application: **25 August 2015**
(24) Date from which industrial property rights may have effect: **25 August 2015**
(54) Product in respect of which the design is registered: **TV receiver with graphical user interface**
(51) International Design Classification: **14-03B**
(74) Name(s) of Attorney(s): **FB Rice**
(71) Name(s) and Address(s) of Applicant(s):
LG Electronics Inc.
128, Yeoui-daero, Yeongdeungpo-gu Seoul 07336 Korea
(72) Name(s) of Designer(s): **Kunsik Lee and Uniyong kim and Goeun Lee and Ryunghwa Rhee**
(45) Registration Date: **08 September 2015**
(30) Convention priority data:
(31) Number (32) Date (33) Country
30-2015-0009568 25 Feb 2015 REPUBLIC OF KOREA
(56) Related Art Documents: **Not Applicable**
(57) Statement of Newness and Distinctiveness: **Newness and distinctiveness reside in the features of pattern and/or ornamentation of a display screen with graphical user interface as illustrated by solid lines in the accompanying representation. The features shown in broken outline are for contextual purposes only and do not form part of the design.**

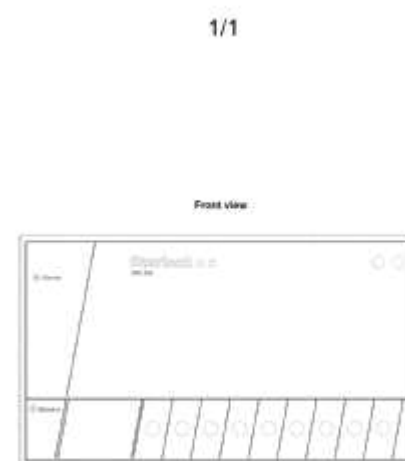

- (21) Design Number: **14342/2015**
(22) Date of Filing Application: **24 August 2015**
(24) Date from which industrial property rights may have effect: **24 August 2015**
(54) Product in respect of which the design is registered: **Dental implant abutment**
(51) International Design Classification: **24-03**
(74) Name(s) of Attorney(s): **Griffith Hack**
(71) Name(s) and Address(s) of Applicant(s):
Nobel Biocare Services AG
Balz Zimmermann - Strasse 7 KLOTEN 8302 Switzerland
(72) Name(s) of Designer(s): **Thomas Vizer and Luca Palmerini and Christian Ebener**
(45) Registration Date: **08 September 2015**
(30) Convention priority data:
(31) Number (32) Date (33) Country
002640573 25 Feb 2015 OFFICE FOR HARMONISATION IN THE INTERNAL MARKET (OHIM)
(56) Related Art Documents: **Not Applicable**
(57) Statement of Newness and Distinctiveness: **Newness and distinctiveness resides in the visual features, including the shape and configuration of the product shown in the representations.**



(21) Design Number: **14343/2015**

(22) Date of Filing Application: **24 August 2015**

(24) Date from which industrial property rights may have effect: **24 August 2015**

(54) Product in respect of which the design is registered: **Dental implant abutment**

(51) International Design Classification: **24-03**

(74) Name(s) of Attorney(s): **Griffith Hack**

(71) Name(s) and Address(s) of Applicant(s):

Nobel Biocare Services AG
Balz Zimmermann - Strasse 7 KLOTEN 8302 Switzerland

(72) Name(s) of Designer(s): **Thomas Vizer and Luca Palmerini and Christian Ebener**

(45) Registration Date: **08 September 2015**

(30) Convention priority data:

(31) Number	(32) Date	(33) Country
002640573	25 Feb 2015	OFFICE FOR HARMONISATION IN THE INTERNAL MARKET (OHIM)

(56) Related Art Documents: **Not Applicable**

(57) Statement of Newness and Distinctiveness: **Newness and distinctiveness resides in the visual features, including the shape and configuration of the product shown in the representations.**



(21) Design Number: **14344/2015**

(22) Date of Filing Application: **24 August 2015**

(24) Date from which industrial property rights may have effect: **24 August 2015**

(54) Product in respect of which the design is registered: **Dental implant abutment**

(51) International Design Classification: **24-03**

(74) Name(s) of Attorney(s): **Griffith Hack**

(71) Name(s) and Address(s) of Applicant(s):

Nobel Biocare Services AG
Balz Zimmermann - Strasse 7 KLOTEN 8302 Switzerland

(72) Name(s) of Designer(s): **Thomas Vizer and Luca Palmerini and Christian Ebener**

(45) Registration Date: **08 September 2015**

(30) Convention priority data:

(31) Number	(32) Date	(33) Country
002640573	25 Feb 2015	OFFICE FOR HARMONISATION IN THE INTERNAL MARKET (OHIM)

(56) Related Art Documents: **Not Applicable**

(57) Statement of Newness and Distinctiveness: **Newness and distinctiveness resides in the visual features, including the shape and configuration of the product shown in the representations.**



(21) Design Number: **14345/2015**

(22) Date of Filing Application: **24 August 2015**

(24) Date from which industrial property rights may have effect: **24 August 2015**

(54) Product in respect of which the design is registered: **Dental implant abutment**

(51) International Design Classification: **24-03**

(74) Name(s) of Attorney(s): **Griffith Hack**

(71) Name(s) and Address(s) of Applicant(s):

Nobel Biocare Services AG

Balz Zimmermann - Strasse 7 KLOTEN 8302 Switzerland

(72) Name(s) of Designer(s): **Thomas Vizer and Luca Palmerini and Christian Ebener**

(45) Registration Date: **08 September 2015**

(30) Convention priority data:

(31) Number
002640573

(32) Date
25 Feb 2015

(33) Country
**OFFICE FOR HARMONISATION IN
THE INTERNAL MARKET (OHIM)**

(56) Related Art Documents: **Not Applicable**

(57) Statement of Newness and Distinctiveness: **Newness and distinctiveness resides in the visual features, including the shape and configuration of the product shown in the representations.**



FIG. 1

(21) Design Number: **14346/2015**

(22) Date of Filing Application: **24 August 2015**

(24) Date from which industrial property rights may have effect: **24 August 2015**

(54) Product in respect of which the design is registered: **Transparent clothes dryer**

(51) International Design Classification: **07-05D**

(74) Name(s) of Attorney(s): **Cullens Patent and Trade Mark Attorneys**

(71) Name(s) and Address(s) of Applicant(s):

Denis Tewheoro Hingston

144 Skyline Dr Kholo QLD 4306 Australia

Amy Mason

144 Skyline Dr Kholo QLD 4306 Australia

Louise Hingston

145 Hillside Tce St Lucia QLD 4067 Australia

(72) Name(s) of Designer(s): **Denis Tewheoro Hingston**

(45) Registration Date: **08 September 2015**

(56) Related Art Documents: **Not Applicable**

(57) Statement of Newness and Distinctiveness: **Newness and distinctiveness is claimed in a clothes dryer having a transparent body and a black drum as shown in the representations. Newness and distinctiveness is not claimed in any of the other features in the design representations.**



Isometric Perspective View

- (21) Design Number: **13107/2015**
(22) Date of Filing Application: **21 June 2015**
(24) Date from which industrial property rights may have effect: **21 June 2015**
(54) Product in respect of which the design is registered: **A label**
(51) International Design Classification: **20-03NES**
(74) Name(s) of Attorney(s):
(71) Name(s) and Address(s) of Applicant(s):
 Alfred Rose
 28 Dequency Rd Bullaburra NSW 2784 Australia
 Samuel Rose
 28 De Quency Rd Bullaburra NSW 2035 Australia
(72) Name(s) of Designer(s): **Samuel Rose and Alfred Rose**
(45) Registration Date: **08 September 2015**
(56) Related Art Documents: **Not Applicable**
(57) Statement of Newness and Distinctiveness: **Initial of cherry plum orchard to be labelled on all fruits and nuts grown on the property.**

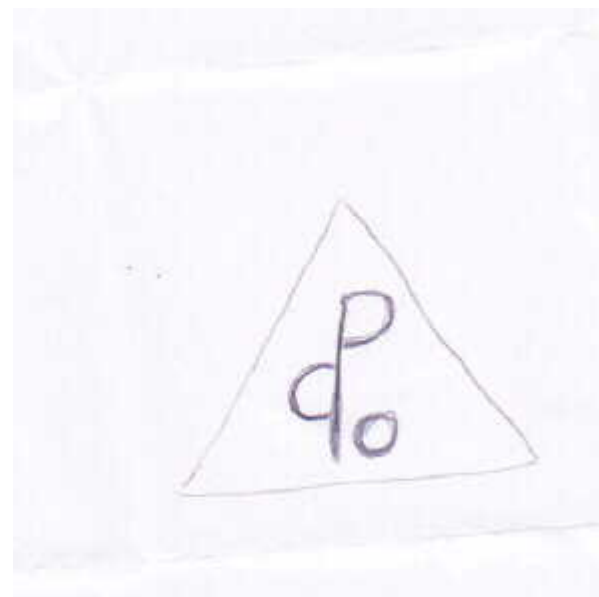

- (21) Design Number: **13237/2015**
(22) Date of Filing Application: **25 June 2015**
(24) Date from which industrial property rights may have effect: **25 June 2015**
(54) Product in respect of which the design is registered: **Mudguard**
(51) International Design Classification: **12-16B**
(74) Name(s) of Attorney(s):
(71) Name(s) and Address(s) of Applicant(s):
 IKAREM PTY LTD
 U2/8 McGregor Ave Black Rock VIC 3193 Australia
(72) Name(s) of Designer(s): **Anthony Heap and Michael Cornish**
(45) Registration Date: **08 September 2015**
(56) Related Art Documents: **Not Applicable**
(57) Statement of Newness and Distinctiveness: **Newness and distinctiveness is claimed in the features of shape and/or configuration of the FLEXIBLE ACCESSORY OF AND RIGID MOUNT ASSEMBLY as illustrated in the accompanying representations and in particular to the cross sectional shape of the flexible accessory and rigid mount.**



(21) Design Number: **13783/2015**
(22) Date of Filing Application: **29 July 2015**
(24) Date from which industrial property rights may have effect: **29 July 2015**
(54) Product in respect of which the design is registered: **Glove**
(51) International Design Classification: **02-06**
(74) Name(s) of Attorney(s): **Davies Collison Cave**
(71) Name(s) and Address(s) of Applicant(s):
Shelby Group International, Inc.
1255 W. Schilling Blvd. Collierville Tennessee, 38017 United States Of America
(72) Name(s) of Designer(s): **Paul S. Harris**
(45) Registration Date: **08 September 2015**
(30) Convention priority data:
(31) Number (32) Date (33) Country
29/516,047 29 Jan 2015 UNITED STATES OF AMERICA
(56) Related Art Documents: **Not Applicable**
(57) Statement of Newness and Distinctiveness: **Newness and distinctiveness is claimed in the visual features of the ornamental design for a glove having a tire tread design on the back of the hand, fingers and thumb portions of the glove, shown in the representations.**



(21) Design Number: **14307/2015**
(22) Date of Filing Application: **21 August 2015**
(24) Date from which industrial property rights may have effect: **21 August 2015**
(54) Product in respect of which the design is registered: **A tyre**
(51) International Design Classification: **12-15C**
(74) Name(s) of Attorney(s): **WATERMARK PATENT AND TRADE MARKS ATTORNEYS**
(71) Name(s) and Address(s) of Applicant(s):
COMPAGNIE GENERALE DES ETABLISSEMENTS MICHELIN
12 cours Sablon Clermont-Ferrand 63000 France
Michelin Recherche et Technique S.A.
Route Louis-Braille 10 Granges-Paccot 1763 Switzerland
(72) Name(s) of Designer(s): **Stephane Oraison and Alexandre Carloni**
(45) Registration Date: **08 September 2015**
(30) Convention priority data:
(31) Number (32) Date (33) Country
2015-0898 24 Feb 2015 FRANCE
(56) Related Art Documents: **Not Applicable**
(57) Statement of Newness and Distinctiveness: **Newness and distinctiveness resides in the appearance of the tread region of the tyre, the remainder of the tyre not forming part of the design.**

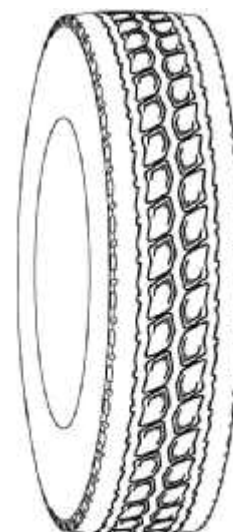

(21) Design Number: **14322/2015**
(22) Date of Filing Application: **24 August 2015**
(24) Date from which industrial property rights may have effect: **24 August 2015**
(54) Product in respect of which the design is registered: **Toaster**
(51) International Design Classification: **07-02F**
(74) Name(s) of Attorney(s): **Freehills Patent Attorneys**
(71) Name(s) and Address(s) of Applicant(s):
Sunbeam Corporation Limited
U5-6 13 Lord St Botany NSW 2019 Australia
(72) Name(s) of Designer(s): **Marc Newson**
(45) Registration Date: **08 September 2015**
(56) Related Art Documents: **Not Applicable**
(57) Statement of Newness and Distinctiveness: **Nil**



(21) Design Number: **14341/2015**
(22) Date of Filing Application: **24 August 2015**
(24) Date from which industrial property rights may have effect: **16 June 2015**
(54) Product in respect of which the design is registered: **Activity monitoring device**
(51) International Design Classification: **10-04**
(74) Name(s) of Attorney(s): **Pizzeys Patent and Trade Mark Attorneys Pty Ltd**
(71) Name(s) and Address(s) of Applicant(s):
Misfit Wearables Corporation
5 Brookdale Road Salem NH, 03079 United States of America
(72) Name(s) of Designer(s): **Timothy Golnik and James Toggweiler**
(45) Registration Date: **08 September 2015**
(30) Convention priority data:
(31) Number (32) Date (33) Country
29/512,056 16 Dec 2014 UNITED STATES OF AMERICA
(62) Divisional of: **13044/2015**
(56) Related Art Documents: **Not Applicable**
(57) Statement of Newness and Distinctiveness: **Nil**

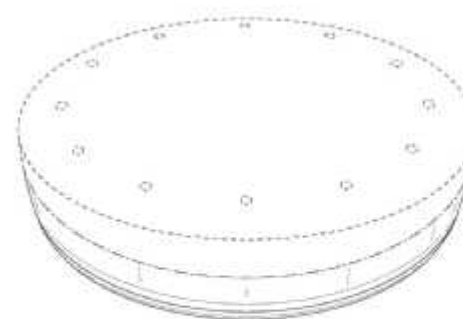

PERSPECTIVE VIEW

- (21) Design Number: **14340/2015**
(22) Date of Filing Application: **24 August 2015**
(24) Date from which industrial property rights may have effect: **16 June 2015**
(54) Product in respect of which the design is registered: **Activity monitoring device**
(51) International Design Classification: **10-04**
(74) Name(s) of Attorney(s): **Pizzeys Patent and Trade Mark Attorneys Pty Ltd**
(71) Name(s) and Address(s) of Applicant(s):
Misfit Wearables Corporation
5 Brookdale Road Salem NH, 03079 United States of America
(72) Name(s) of Designer(s): **Timothy Golnik and James Toggweiler**
(45) Registration Date: **08 September 2015**
(30) Convention priority data:
(31) Number (32) Date (33) Country
29/512,056 16 Dec 2014 UNITED STATES OF AMERICA
(62) Divisional of: **13044/2015**
(56) Related Art Documents: **Not Applicable**
(57) Statement of Newness and Distinctiveness: **Nil**

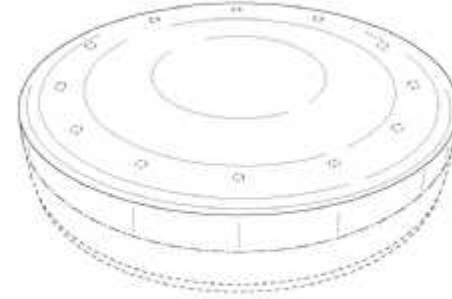

PERSPECTIVE VIEW